

MADE IN FRANCE SINCE 1964



# Car Body Welding System

Catalogue Carrosserie  
Karosserie-Schweißtechnik Katalog  
Catálogo de Soldadura para Carrocería

**2018**  
[www.gys.fr](http://www.gys.fr)

SPOTTER • DENT PULLER • MIG • PLASMA • INDUCTION • LIFT • RIVETING • ACCESSORIES



## A family firm since 1964

Une société familiale depuis 1964  
 Familienunternehmen seit 1964  
 Una empresa familiar desde 1964  
 Un'azienda familiare dal 1964  
 Een familiebedrijf sinds 1964

3



40 000 m<sup>2</sup>  
 400 000 sqf



630+

120

Partenaires • Partners • Asociados • Partner



# High tech R&D

R&D de pointe  
Hochmodernes F&E  
I+D de tecnología punta  
R&S di punta  
Hoogwaardige R&D

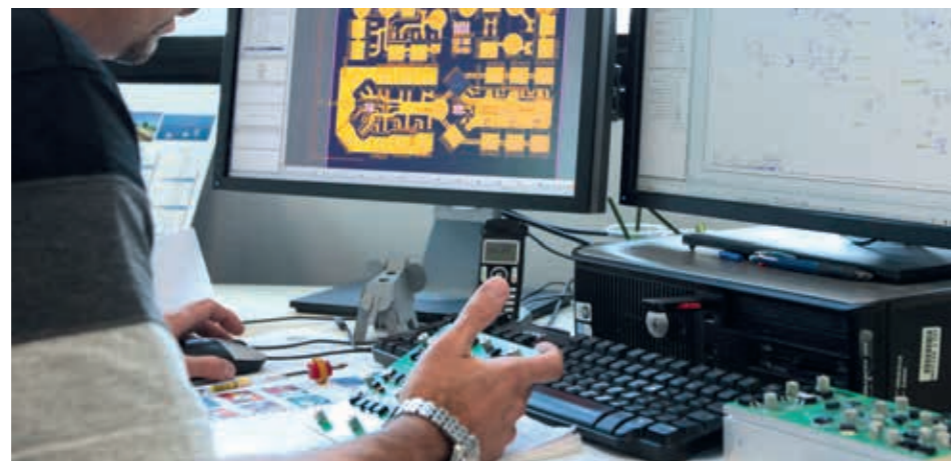

# GYS Academy

Académie • Akademie  
Academia • Accademia  
Academy

Centre de formation agréé  
Training centre dedicated to professionals  
Trainingcenter für Profis  
Centro de formación autorizado  
Centro di formazione dedicato ai professionisti  
Erkend opleidingscentrum

Formations agréées  
Ref. 52 53 0068153



Electronics • Électronique • Elektronik



Painting • Peinture • Lackierstraße



Cable work • Filerie • Kabelkonfektionierung



# 100% GYS



Mechanical engineering • Mécanique • CNC-Bearbeitung



Metal work • Tôlerie • Blechbearbeitung



Transformers • Transformateurs • Transformatoren

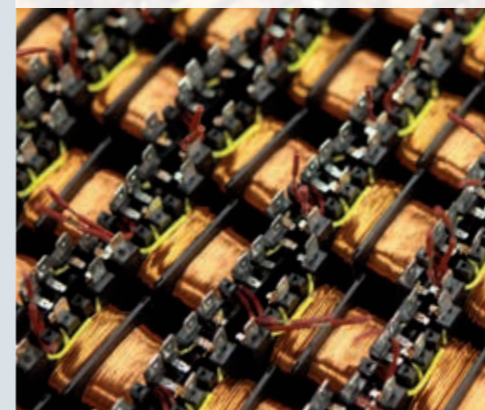

Assembly • Montage/tests • Montage



**GYS**  
**GYSPOT 2600** Acier/Steel /Stahl 230V  
**2600 A**

052208



**OPTION**  
**SPOTTER BOX 2600**  
 052277



**OPTION**  
**Chariot- trolley SPOT 600**  
 053533



**GYS**  
**GYSPOT 39.02** Acier/Steel /Stahl 230V 052215  
**GYSPOT 39.04** Acier/Steel /Stahl 400V 052222  
**3800 A**



**OPTION**  
**SPOTTER BOX 2700**  
 053922

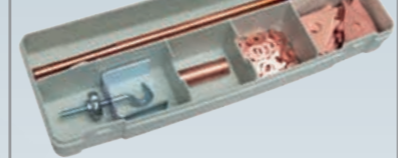

**OPTION**  
**Chariot- trolley SPOT 1000**  
 053540



**GYS**  
**GYSPOT 2700** Acier/Steel /Stahl 230V  
**2600 A**

055353



CARBON HEATING ELECTRODE 049468



**+** INCLUDED  
**SPOTTER BOX STANDARD**  
 053915  
 Details p.14



**OPTION**  
**Chariot- trolley SPOT 1000**  
 053540



**OPTION**  
**Chariot- trolley UNIVERSAL 800**  
 051331



**QUICK GUN**

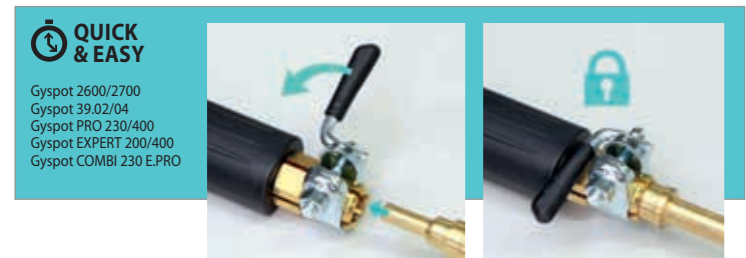

MADE IN FRANCE 62135	50/60 Hz	I <sub>2</sub> max A	U <sub>2</sub> V	-AM- A	I <sub>RMS</sub> A	kW	Acier/Steel	MANUAL	SYNERGIC	SYNERGIC CONTROL	GUN			CABLE	ELECTRODE	MODE	CABLE LENGTH	WHEELS	OPTION	DIMENSIONS	WEIGHT		
											AUTOMATIC	MANUAL	SEPARATE CABLE GUN										
<b>GYSPOT 2600</b>	230V	2600	5,4	16	1800	10	OK	—	—	—	—	—	—	—	—	—	1,8 m	Auto	—	2 m	Option Spotter box 2600	20 x 32 x 18	14
<b>GYSPOT 2700</b>	230V	2600	5,4	16	1800	10	OK	—	—	—	—	—	—	—	—	—	1,8 m	—	—	2 m	Option Spotter box 2700	20 x 32 x 18	14
<b>GYSPOT 39.02</b>	230V	3800	7,4	16	2800	20	OK	OK	—	—	—	—	—	—	—	—	2 m	Auto	—	4 m	Included Spotter box	22,5 x 36 x 23,5	23
<b>GYSPOT 39.04</b>	400V, 2ph	3800	7,4	16	2800	20	OK	OK	—	—	—	—	—	—	—	—	2 m	Auto	—	4 m	Included Spotter box	22,5 x 36 x 23,5	23

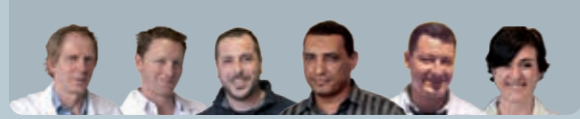

	<b>GYSPT PRO 230</b>	Acier/Steel /Stahl	230V	052178
	<b>GYSPT PRO 400</b>	Acier/Steel /Stahl	400V	052185
<b>2 3800 A</b>				
<b>GUNS</b>				

	<b>GYSPT EXPERT 200</b>	Acier/Steel /Stahl	200/240V	058842
	<b>GYSPT EXPERT 400</b>	Acier/Steel /Stahl	400V	058859
<b>2 4500 A</b>				
<b>GUNS</b>				



**+ INCLUDED SPOTTER BOX PRO**  
050075  
Details p.15

**+ INCLUDED SPOTTER BOX PRO**  
050075  
Details p.15



**OPTION Chariot-trolley UNIVERSAL 800**  
051331

**OPTION Chariot-trolley SPOT 1000**  
053540

**OPTION Chariot-trolley UNIVERSAL 800**  
051331

**OPTION Chariot-trolley SPOT 1000**  
053540

**QUICK GUN**

**QUICK & EASY**

Gyspot 2600/2700  
Gyspot 39.02/04  
Gyspot PRO 230/400  
Gyspot EXPERT 200/400  
Gyspot COMBI 230 E.PRO

 MADE IN FRANCE  62135	 50/60 Hz	$I_2$ max A	$U_2$ V	 A	$I_{RMS}$ A	kW	 OK	 OK	 MANUAL	 SYNERGIC	 	 	 	 	 	 	 cm	 kg		
																			SEPARATE CABLE GUN	 
<b>GYSPT PRO 230</b>	230V	<b>3800</b>	7,4	16	2800	20	OK	OK	—	▪	▪	▪	▪	2 m + 3 m	Auto	▪	8 m	Included Spotter box (with studs)	22,5 x 36 x 23,5	25,5
<b>GYSPT PRO 400</b>	400V, 2ph	<b>3800</b>	7,4	16	2800	20	OK	OK	—	▪	▪	▪	▪	2 m + 3 m	Auto	▪	8 m	Included Spotter box (with studs)	22,5 x 36 x 23,5	25,5
<b>GYSPT EXPERT 200</b>	200 > 240V	<b>4350&gt;5100</b>	7,2>8,7	30(D)	3100 > 3600	25 > 36	OK	OK	▪	▪	▪	▪	▪	2 m + 3 m	Auto	▪	8 m	Included Spotter box (with studs)	22,5 x 36 x 23,5	31,5
<b>GYSPT EXPERT 400</b>	400V, 2ph	<b>4500</b>	7,4	16(D)	3200	25	OK	OK	▪	▪	▪	▪	▪	2 m + 3 m	Auto	▪	8 m	Included Spotter box (with studs)	22,5 x 36 x 23,5	31,5



**GYSPT ALU PRO FV** Alu 110 > 230V  
**7 500 A**

**GYSPT COMBI 230 E.PRO** Acier/Steel /Stahl + Alu 230V  
**3 800 A 7 500 A**

021990

021266

SYNERGIC CONTROL  
Alu

SYNERGIC CONTROL  
Acier/Steel/Stahl

NEW  
SOFT



PATENTS REGISTERED NUMBERS  
EUROPEAN TRADEMARK & DESIGN

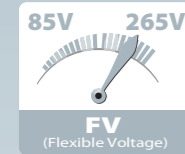

NEW DESIGN  
**66 000µF**

Process Alu

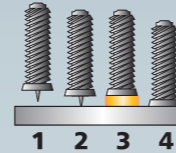

Alu Gun  
Easy



PATENTS REGISTERED NUMBERS  
EUROPEAN TRADEMARK & DESIGN



QUICK GUN

QUICK & EASY

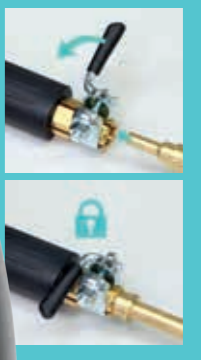

2m  
Ø70mm²

NEW DESIGN  
**66 000µF**

**3 GUNS INCLUDED**

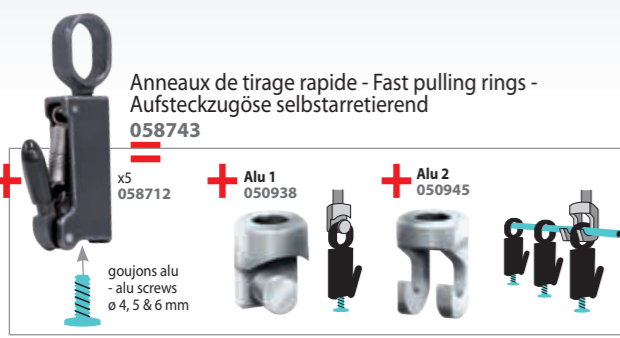

Options (more p.18-19)



MADE IN FRANCE 62135	SYNERGIC	GUN		SEPARATE CABLE GUN	U <sub>2</sub> V	I <sub>AM</sub> A	I <sub>RMS</sub> A	kW	OK	OK	cm	kg	
		Acier/Steel	Alu										
<b>GYSPT ALU PRO FV</b>	110>230V	7500	—	AUTOMATIC	—	50 > 200	5	—	0,65	OK	OK	21 x 24 x 36	14
<b>GYSPT COMBI 230 E.PRO</b>	230V	3800 (steel) 7500 (alu)	x2 AUTOMATIC + MANUAL	AUTOMATIC	—	7,4 (steel) 20 > 200 (alu)	16	2800 (steel)	20	OK	OK	45 x 43 x 29	49,7

**MARTEAUX INERTIE - Slide hammers - Ausziehhammer**

**1,1 kg**  
049802

**COMPLETE**  
057272

(x20) 052239

(x1) 049482

(x1) 054028

(x5) 050839

**1,1 kg**  
041813

Clous - Nails  
- Nägel

Ø 2, M4 (x1)  
049277

Ø 2 (x100)  
041561

MIG/MAG nozzle  
for Nail welding  
041523

**1,7 kg**  
051201

Rondelles - Washers  
- Ringe

Ø 16,8x16 (x1)  
049574

(x1) 051218

8x16 (x100)  
049444

51 cm

Griffes - Gripping hook head  
- Ausbeulkit

049819

**2,5 kg**

**COMPLETE KIT**  
051225

(x1) (x50)

(x1) (x25)

**LEVIER DE DÉBOSELAGE - Levelling lever - Zughebel**

PATENTS REGISTERED NUMBERS  
001652108-0002  
EUROPEAN TRADEMARK & DESIGN

050686

(x2) 052451

55 mm

**BARRE DE DÉBOSELAGE DOUBLE ACTION - Levelling bar double action - Zughebelbrücke**

053564

0,86 m

Barre de traction - Traction bar - Zugstange

Barre renforcée - Strengthened bar

1,20 m  
051171

Support double patin - Double pads support  
- Doppelfüße

Option: (x1) 058439

050723

**BARRE DE DÉBOSELAGE - Levelling bar - Zugbrücke**

050693

0,85 m

Griffes 2 dents  
057296

Poignée de tirage 2 dents

Ø M10 / M14

049758

057319

**BARRE DE TIRAGE RENFORCÉE - Scissoring bar - Scherenzugbrücke**

050716

Barre renforcée  
Strengthened bar

0,85 m

PATENTS REGISTERED NUMBERS  
001652108-0001  
EUROPEAN TRADEMARK & DESIGN

(x1) 058439

(x1) 056794

(x1) 056800

Griffes - Gripping hook head - Ausbeulkit

Ø M10 / M14

049734

Ø M10 / M14

049741

**MANUSPOT**

050679

for SPOT 600,  
800, 1000, 1600  
& Workstation

PATENTS REGISTERED NUMBERS  
001652108-0003  
EUROPEAN TRADEMARK & DESIGN

3 m  
Ø 35 mm<sup>2</sup>

4 positions • 4 Positionen

**EASY TOOL CONNECTION**

Gyspot 39.02/04 • Gyspot PRO230/400  
GYSPOT COMBI 230 PRO

**EASY GUN**  
051317

051584

380 g

Anneaux - Rings  
- Anschweißösen

051652

Fils ondulés - Wavy wires  
- Wellendraht

051669

Rétreinte - Tempering  
- Glättwerkzeug

051676

OPTION 057289

**MANULINER/GUN**

056831

Adapter for gun included  
(Ref. 052499)

PATENTS REGISTERED NUMBERS  
001652108-0003  
EUROPEAN TRADEMARK & DESIGN

4 positions • 4 Positionen

**MANULINER**

050471

**EASY GUN**  
051317

051584

380 g

Anneaux - Rings  
- Anschweißösen

051652

Fils ondulés - Wavy wires  
- Wellendraht

051669

Rétreinte - Tempering  
- Glättwerkzeug

051676

OPTION 057289

**POIGNÉE DE TIRAGE MANUEL**

057289

**RINGMATIC**

052154

included (x 50)

052154

**QUICK SPOT AIR GUN V2**

**NEW 2018**

Light weight  
920 g

2,5 m

057340

AIR

**MANUSPOT/MANULINER**

Box of 3 electrodes for accessories  
050822

**MANUSPOT / MANULINER / QUICK SPOT AIR GUN**

Direct impact electrodes  
(x5)  
050839

**OPTION - ADAPTATEUR POUR PISTOLET - Adapter for gun**

For RINGMATIC  
& MANUSPOT  
052499

Adaptateur texas For QUICK SPOT AIR GUN

052826

**LAMPE LIGNE DROITE - Straight line lamp - Dentline-laser**

056770



**CONSOMMABLES ACIER - Steel consumables - Stahl-Verbrauchsmaterial**

**BEST SELLER**

**DENT BOX BAR**  
050037

**SPOTTER BOX 2600**  
052277

**SPOTTER BOX 2700**  
053922

**SPOTTER BOX STANDARD**  
053915

Icons: Proliner OPTION, 2600 OPTION, 2700 OPTION

x 25		WAVY WIRES x 50 049727	x 25
x 50		STRAIGHT PULLING RINGS x100 050648	x 50
x 1		LIFTING ROD x3 050792	x 1
x 1		ELECTRODE FOR WAVY WIRES x 1 049789	x 1
x 1		ELECTRODE FOR RINGS x 1 050655	x 1

x 20		STAR WITH COPPER COATING x 20 052239	Dent Box Easy x 10 Spotter Box Pro x 20
x 1		ELECTRODE FOR RINGS ø 16 - 8 x 16 x 1 049574	x 1
x 50		CENTERING RINGS ø 8 x 16 x 100 049444	x 50
x 1		EARTH HOOK x 1 056718	x 1
x 1		CARBON HEATING ELECTRODE x 5 049468	x 1

x 1		STAR-CHUCK FOR INERTIA HAMMER x 1 049482	x 1
x 1		HEXAGON KEY	x 1
x 1		EARTH PLATE	x 1
x 1		ELECTRODE WARMING POINT - ø 16 x 1 049567	x 1

x 1		ELECTRODE FOR AUTO-THREADED RIVETS ø 5 - M5, M6 x 1 049598	x 1
x 1		ELECTRODE FOR RIVETS ø 16, 3 x 4,50 x 1 049604	x 1
x 50		THREADED STUDS M5 x 18 x 0,8 x 100 049383	x 50
x 50		SELF-THREADING STUDS ø 5 x 18 x 100 049420	x 50
x 50		SELF-THREADING STUDS ø 5 x 12 x 100 049413	x 50
x 100		RIVETS - ø 3 x 3,25 x 100 049345	x 100
x 100		RIVETS - ø 3 x 4,50 x 100 049352	x 100

**more**

	SQUARE LOCK NUT - M8 (x100) 050303		SINGLE HOOK (x1) 051218
	MAGNETIC POSITIONER (x1) 049772		ELECTRODE WHEEL ø16 (x1) 050310
	MAGNETIC EARTH (x1) 049666		EARTH PLATE (x1) 052529
	ELECTRODE FOR MAGNETIC EARTH (x1) 050013		ELECTRODE FOR NAILS ø 2 - M4 (x1) 049277
	THREADED ROD FOR MAGNETIC EARTH (x5) 055438		NAIL ø2 (x100) 041561
			FLAT KEY N°27 049673

**DENT BOX EASY**  
053632

Easyliner INCLUDED

**SPOTTER BOX PRO**  
050075

Pro 230  
Pro 400  
Expert 200  
Expert 400  
Combi 230  
INCLUDED

**BEST SELLER**

**DENT BOX CONSUMABLES**  
051515

x 25		WAVY WIRES x 50 049727
x 20		STARS WITH COPPER COATING x 20 052239
x 50		STRAIGHT PULLING RINGS x 100 050648
x 25		TWISTED PULLING RINGS x 50 050631

**CONSOMMABLES ALU - Alu consumables - Alu-Verbrauchsmaterial**

**ALU BOX LIGHT (Ø4)**  
051522

**ALU BOX STANDARD (Ø4)**  
050020

Gyspot Alu  
Combi 230  
INCLUDED

x 200		ALU MAGNESIUM SCREWS 12 mm - ø 4 - M4 x 200 050273 x 1000 050129
x 200		ALU SILICON SCREWS 12 mm - ø 4 - M4 x 200 050280 x 1000 050136
x 5		SCREWABLE RINGS ø 4 x 5 050297
x 1		LIFTING ROD x 3 050792

**ALU BOX Ø5 & 6**  
048195

	MANDREL FOR ALU GUN	ø 5	048157	x 1
		ø 6	048164	x 1
	ALU MAGNESIUM SCREWS 12 mm	ø 5	048140	x 100
		ø 6	048133	x 100
	ALU SILICON SCREWS 12 mm	ø 5	048126	x 100
		ø 6	048003	x 100
	SCREWABLE RINGS	ø 5	052635	x 5
		ø 6	052628	x 5

**more (Ø4)**

	MANDREL FOR ALU GUN - Ø 4 (x2) 049000		Alu 1 x1 050938
	TENSION MANDREL FOR M4 (x1) 050327		Alu 2 x1 050945

**ANNEAUX DE TIRAGE RAPIDE**  
- Fast pulling rings - Aufsteckzugöse selbstarretierend  
058743

**+**

**+** Alu 1 050938

**+** Alu 2 050945

x5 058712

goujons alu - alu screws ø 4, 5 & 6 mm

**MANDRINS POUR PISTOLETS - Mandrels for gun - Pistole mit Anschlussstücke, Zubehör**

**Pour déboussieurs - for dent pullers - Anschlussstück für Ausbeulpotter-Pistole**

**QUICK GUN** 057531

**D1** 048959

**Pour soudeuses par point - for spot welding machines - Anschlussstück für Monopunktpistole**

**S1** (< nov 2010) 048171

**S2 - NEW** (> nov 2010) 048188

**Écrou - Nut** 053199

**Microswitch** 053267

**MASSE PISTOLET ACIER - Steel gun earth adapter - Masse für Stahl Pistole**

**051997**

Ø 25 mm<sup>2</sup>

**AFFÛTEUR PNEUMATIQUE D'ANNEAUX - Pneumatic Bit Cutter**

**056763**

Made in P.R.C.

pour anneaux de tirage droits ou torsadés - for straight or twisted pulling rings





**Acier/Steel/Stahl**

**EASYLINER**

<b>2700</b> (230V)	<b>39.02</b> (230V)
2 600A	3 800A
055445	053618

GYSPT 2700      GYSPT 39.02

+      +

Trolley SPOT 1000 053540      Dent box easy 053632 (p.15)

Levelling bar double action 053564 (p.12)

0,86 m

**ALL IN 1 BOX**

**Acier/Steel/Stahl**

**PROLINER**

<b>39.02</b> (230V)	<b>39.04</b> (400V)	<b>PRO 230</b> (230V)	<b>PRO 400</b> (400V)
035775	035782	035799	035805

GYSPT 39.02      GYSPT 39.04      GYSPT PRO 230      GYSPT PRO 400

+      +      +      +

Trolley UNIVERSAL 800 051331      Cable support 052284

Levelling bar double action 053564 (p.12)      Dent box bar 050037 (p.14)

0,86 m



**Spot 600**  
053533

**Universal 800**  
051331

**Spot 1000**  
053540

**Spot 1600**  
051348

**Workstation**  
050747

**Dentstation PRO**  
056848

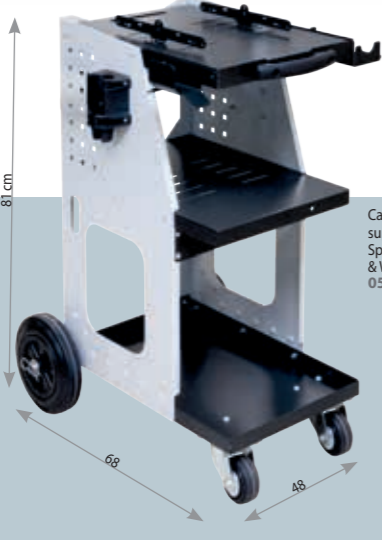

Cable support for Spot 800, 1600 & Workstation 052284



x10 Included Fixing kit 051362

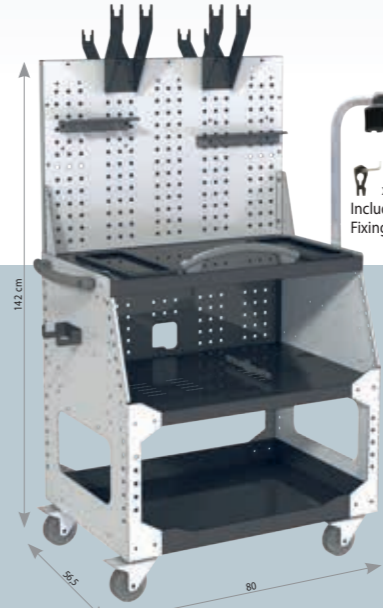

x10 Included Fixing kit 051362

**OPTIONS**

Manuliner 050471

Ringmatic 052154

QUICK SPOT AIR GUN 057340



**Acier/Steel/Stahl**

SPEEDLINER		SPEEDLINER	
<b>39.02</b> (230 V)	<b>39.04</b> (400 V)	<b>PRO 230</b> (230 V)	<b>PRO 400</b> (400 V)
035010	035027	036017	036024

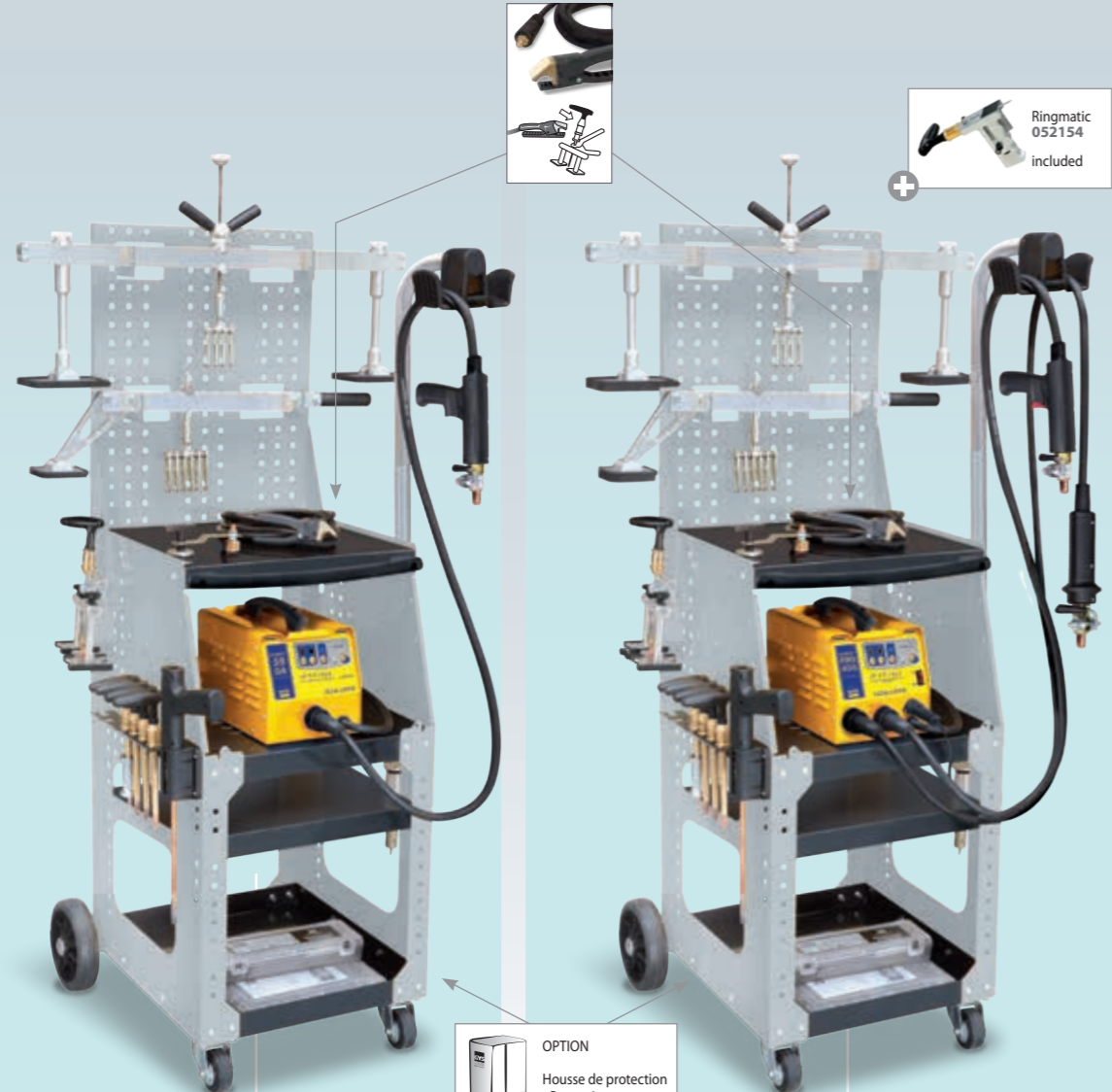

OPTION  
Housse de protection  
- Protection cover  
- Schutzhaube  
048881



GYSPT 39.02









GYSPT 39.04

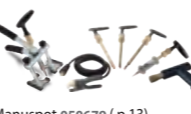

GYSPT PRO 230



GYSPT PRO 400

-  Trolley SPOT 1600 051348
-  Manuspot 050679 ( p.13)
-  Leveling bar 050693 (p.12)
-  Leveling lever 050686 (p.12)
-  052451 (p.12)
-  4 gripping multihook head 049758 (p.12)
-  6 gripping multihook head 049734 (p.12)
-  3 lifting rods 050792 (p.14)
-  Dent box consumables 051515 (p.15)
-  Magnetic earth 049666 (p.14)

**SPEEDLINER**  
(without generator)  
035058

-  Workstation 050747
-  Fixing kit 051362
-  Manuspot 050679 ( p.13)
-  Leveling bar 050693 (p.12)
-  Scissoring bar 050716 (p.12)
-  Double pads support 050723 (p.10)
-  Leveling lever 050686 (p.12)
-  Strengthened bar 1,2m 051171 (p.12)
-  052451 (p.12)
-  4 gripping multihook head 049758 (p.12)
-  6 gripping multihook head 049734 (p.12)
-  8 gripping multihook head 049741 (p.12)
-  3 lifting rods 050792 (p.14)
-  Dent box consumables 051515 (p.15)
-  Magnetic earth 049666 (p.14)

**GYSLINER**  
(without generator)  
035133

**Acier/Steel/Stahl**

GYSLINER		GYSLINER	
<b>39.02</b> (230 V)	<b>39.04</b> (400 V)	<b>PRO 230</b> (230 V)	<b>PRO 400</b> (400 V)
035096	035102	036031	036048

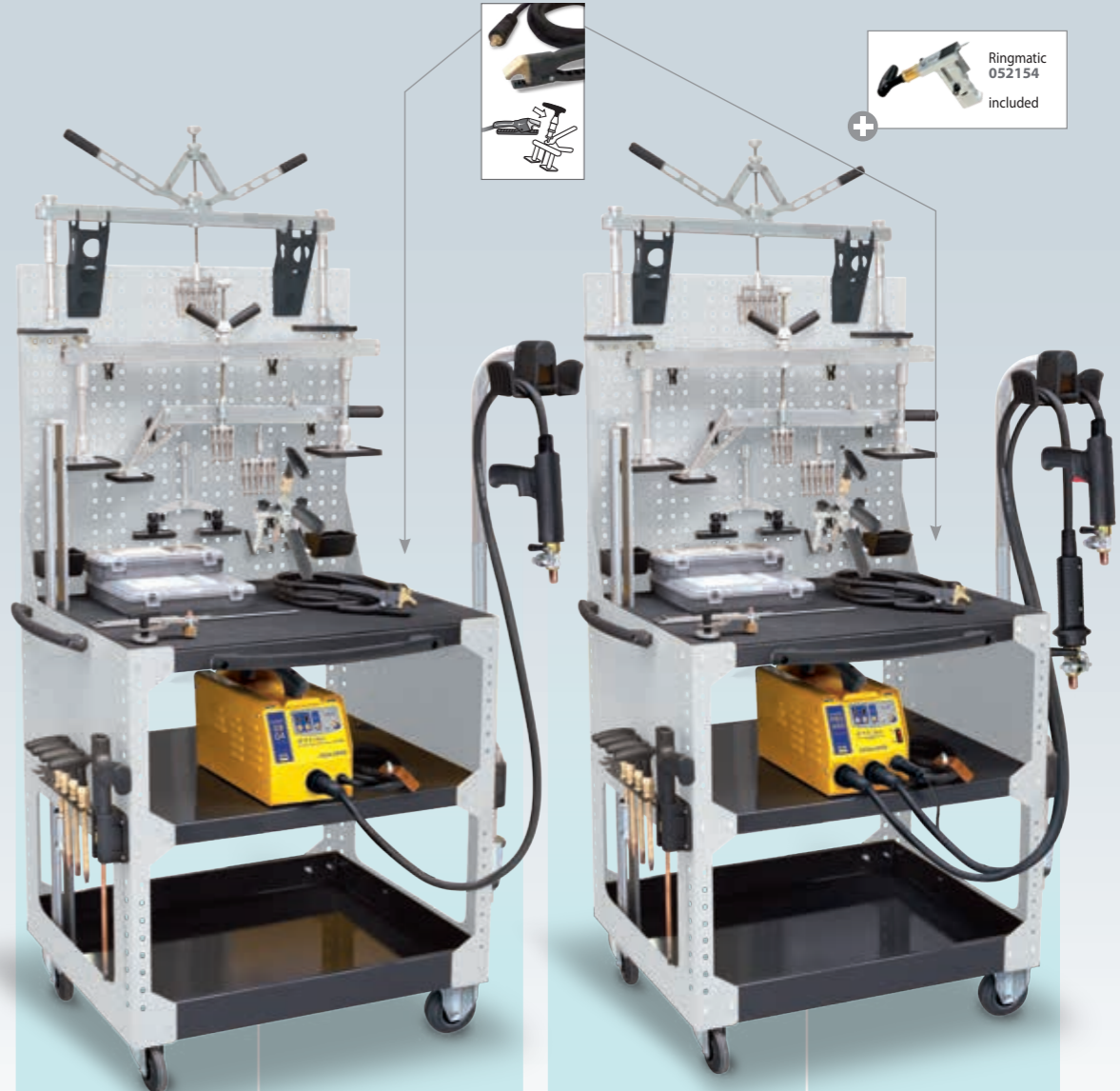

GYSPT 39.02



GYSPT 39.04



GYSPT PRO 230



GYSPT PRO 400

**MARTEAUX ALU**  
- Alu hammers

020986

**ALU**



**ALU PULLER**

051003

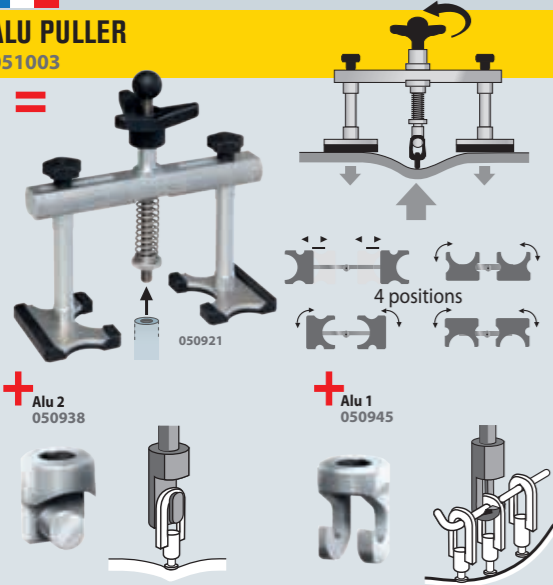

**ANNEAUX DE TIRAGE RAPIDE**

- Fast pulling rings - Aufsteckzugöse selbstarretierend

058743

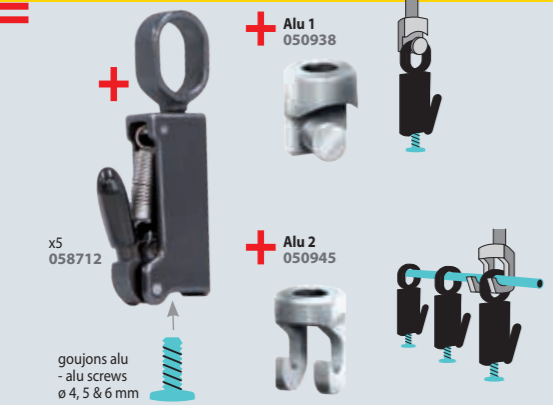

**ASPIRATEUR PNEUMATIQUE POUR POUSSIÈRES ALUMINIUM (ATEX) - Pneumatic aluminium dust atex vacuum cleaner**

058866

Dust container capacity : 25 l  
Working compressed air pressure : 6 bar  
Compressed air consumption at 6 bar : 800 l/min  
Suction connection diameter size : 50 mm  
Max suction capacity : 150 m<sup>3</sup>/h  
Max vacuum level : 2000 mm H<sub>2</sub>O  
Recommended compressor power : 7.5 HP

↳ 74 x 45 x 45 mm  
▲ 18 kg



included  
Filtre - Filter  
058873

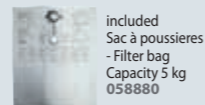

included  
Sac à poussières  
- Filter bag  
Capacity 5 kg  
058880

Marteau à inertie - Inertia hammer - Auszieh-hammer



380 g  
050051

Lampe à souder - Blow torch - Lötlampe

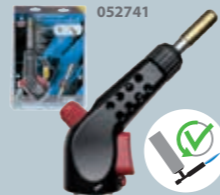

052741

Novacet + (Butane/propane/propylene) 380 ml/220 g 040441



HIGH QUALITY

Brosses - Brushes - Bürsten - Brosses - Cepillos

Inox - Stainless - Edelstahl 044258



Crayon marqueur thermique - Thermal marking pencil



052765

121°C / 250°F

Thermomètre infrarouge - Infrared Thermometer - InfrarotThermometer

052994

-50 / +380°C  
-58 / +716°F



Spray refroidisseur - Freezer spray

-50 °C  
400 ml  
(x 12)  
048898



Gel barrière thermique - Heat barrier spray

054325



Housse de protection SPEEDLINER - Protection cover - Schutzhaube 048881



**Alu**  
**PROLINER ALU PRO FV**

035836



GYSPT ALU PRO FV



Trolley UNIVERSAL 800



Alu puller 051003



Cable support 052284



GYSPT ALU PRO FV



Trolley SPOT 1600 051348



Alu puller 051003



Fixing kit 051362

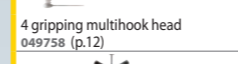

4 gripping multihook head 049758 (p.12)



Levelling bar 050693 (p.12)



Alu Box 05 & 6 048195 (p.15)



Alu hammers 020986

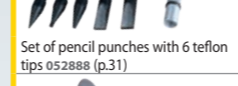

Set of pencil punches with 6 teflon tips 052888 (p.31)



Mini disc sander 051829 (p.78)



051423 (p.74)



Infrared Thermometer 052994

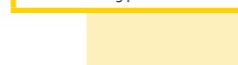

Thermal marking pencil 052765



**Alu**  
**SPEEDLINER ALU PRO FV**

036055





Acier/Steel/Stahl **+** Alu  
**SPEEDLINER COMBI 230 E.PRO**  
 036062

**Complete solution**



Ringmatic 052154 included

GYSLOT COMBI 230 E.PRO	Trolley SPOT 1600 051348
Manuspot 050679 (p.15)	
4 gripping multihook head 049758 (p.14)	6 gripping multihook head 049734 (p.14)
Levelling bar 050693 (p.12)	Levelling lever 050686 (p.12)
Ringmatic (p.13) 052154	
3 lifting rods 050792 (p.14)	
052451 (p.14)	Magnetic earth 049666 (p.14)
Dent box consumables 051515 (p.15)	
Spotter box pro 050075 (p.15)	

Alu puller 051003 (p.20)	Cable support 052284
Alu box standard 050020 (p.15)	

GYSLOT COMBI 230 E.PRO	Workstation 050747
Manuspot 050679 (p.12)	
Fixing kit 051362	Double pads support 050723 (p.12)
4 gripping multihook head 049758 (p.12)	6 gripping multihook head 049734 (p.12)
8 gripping multihook head 049741 (p.12)	Double pads support 050723 (p.12)
Levelling bar 050693 (p.12)	Levelling lever 050686 (p.12)
Ringmatic (p.13) 052154	Scissoring bar 050716 (p.12)
Strengthened bar 1,2m 051171 (p.12)	
3 lifting rods 050792 (p.14)	
052451 (p.12)	Magnetic earth 049666 (p.14)
Dent box consumables 051515 (p.15)	
Spotter box pro 050075 (p.15)	

Alu puller 051003 (p.20)	Cable support 052284
Alu box standard 050020 (p.15)	

Acier/Steel/Stahl **+** Alu  
**GYSLINER COMBI 230 E.PRO**  
 036079

**Expert solution**

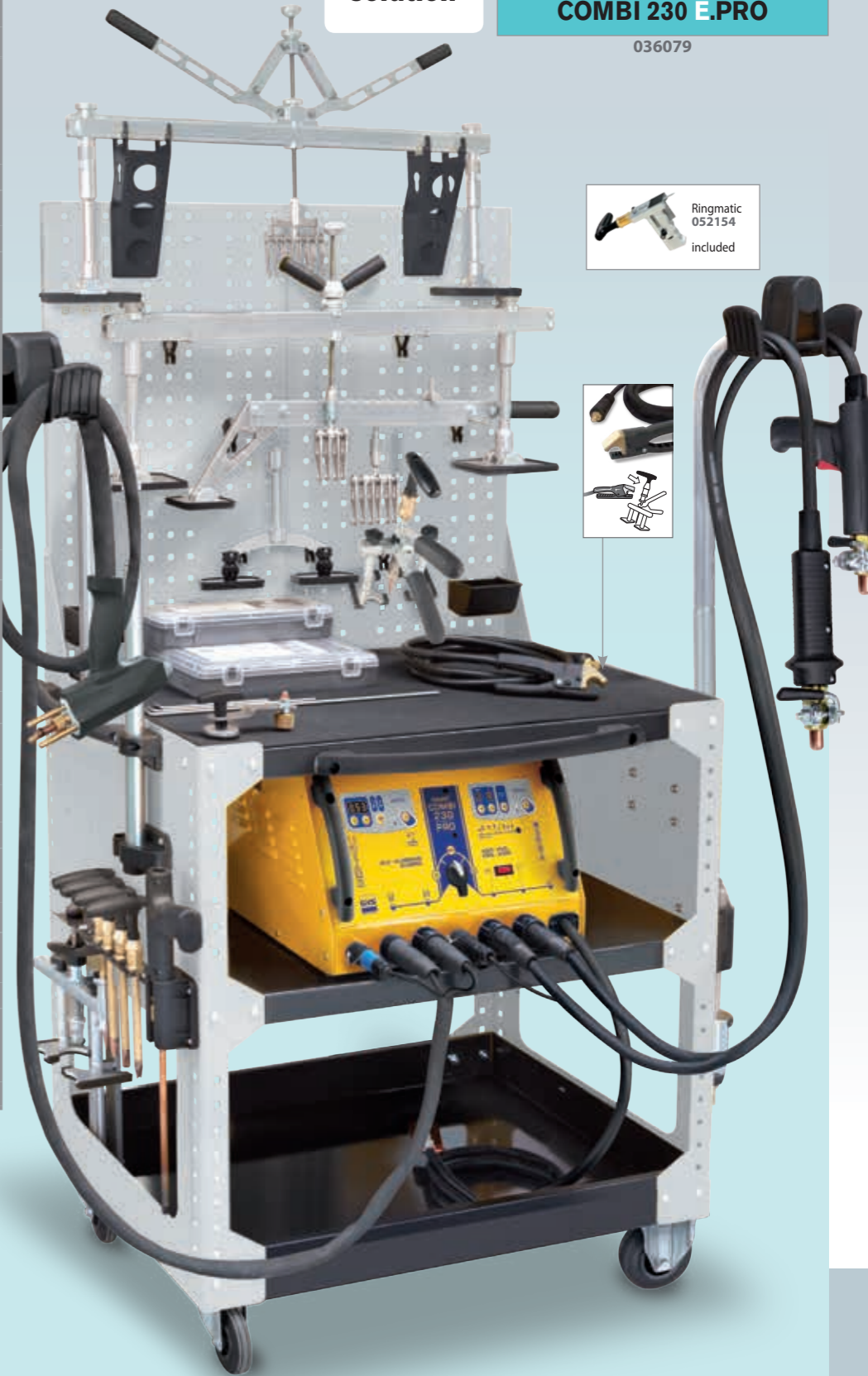

Ringmatic 052154 included

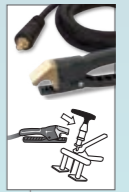

WORKSTATIONS • SERVANTES

**OPTION**  
  
 QUICK SPOT AIR GUN (p.13) 057340

Housse de protection - Protection cover - Schutzhaube  
 048881

Acier/Steel/Stahl

DENTSTATION

EXPERT 200 (200-240V)  
036734

EXPERT 400 (400V)  
036741

PRO 230 (230V)  
036420

PRO 400 (400V)  
036437



GYSPOT EXPERT 200



GYSPOT EXPERT 400



GYSPOT PRO 230

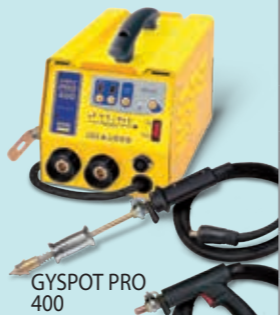

GYSPOT PRO 400

Acier/Steel/Stahl + Alu

DENTSTATION COMBI 230 E.PRO

036444

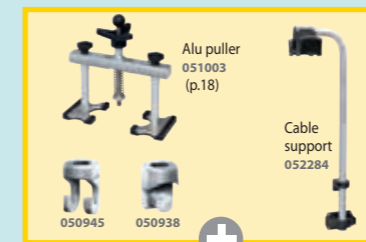

050945 050938



GYSPOT COMBI 230 E.PRO

	Dentstation Pro 056848
	x10 x2 Fixing kit 051362
	Manuspot 050679 ( p.13)
	Ringmatic 052154 (p.13)
	Manual pulling handle 057289 (p.13)
	Levelling bar 050693 (p.12)
	Scissoring bar 050716 (p.12)
	Double pads support 050723 (p.12)
	Levelling lever 050686 (p.12)
	Strengthened bar 1,2m 051171 (p.12)
	052451 (p.12)
	4 gripping multihook head 049758 (p.12)
	6 gripping multihook head 049734 (p.12)
	8 gripping multihook head 049741 (p.12)
	3 lifting rods 050792 (p.14)
	Dent box consumables 051515 (p.15)
	Magnetic earth 049666 (p.14)

	Dentstation Pro 056848
	x10 x2 Fixing kit 051362
	Manuspot 050679 ( p.13)
	Ringmatic 052154 (p.13)
	Manual pulling handle 057289 (p.13)
	Levelling bar 050693 (p.12)
	Scissoring bar 050716 (p.12)
	Double pads support 050723 (p.12)
	Levelling lever 050686 (p.12)
	Strengthened bar 1,2m 051171 (p.12)
	052451 (p.12)
	4 gripping multihook head 049758 (p.12)
	6 gripping multihook head 049734 (p.12)
	8 gripping multihook head 049741 (p.12)
	3 lifting rods 050792 (p.14)
	Dent box consumables 051515 (p.15)
	Magnetic earth 049666 (p.14)

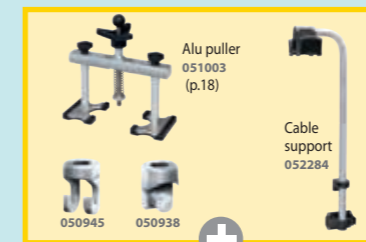

050945 050938



GYSPOT COMBI 230 E.PRO

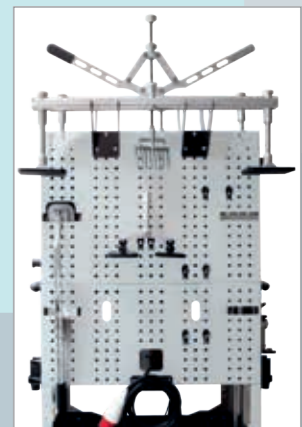

ÉQUERRE DE TIRAGE

- Draw aligner - Schnellausbeul-Richtausleger

052475

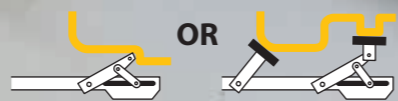
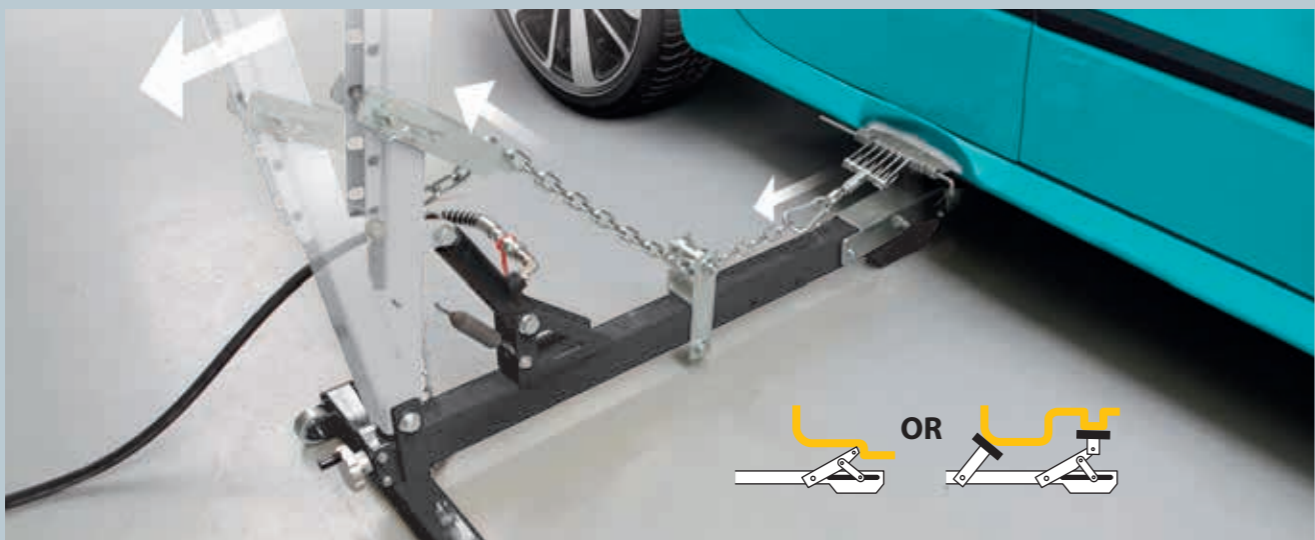
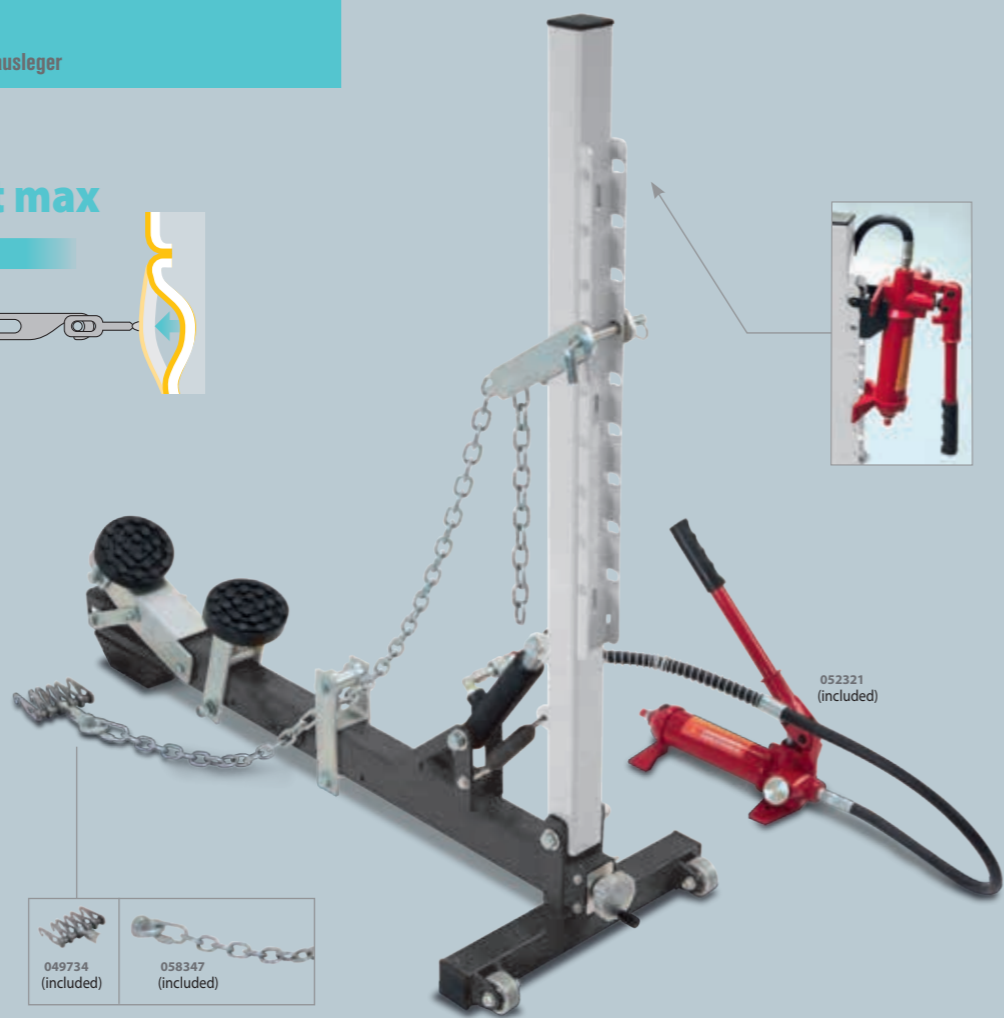
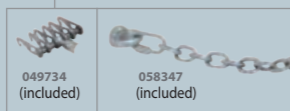
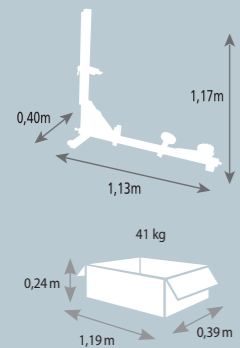
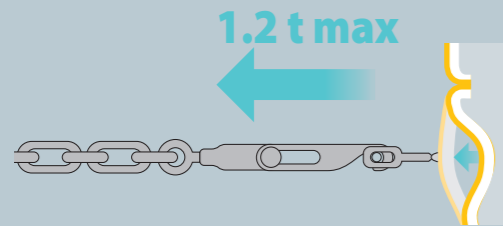

OPTION  
Bras de bas de caisse  
- Rocker panel arms  
for draw aligner  
- Abstütztraverse  
für Richtausleger

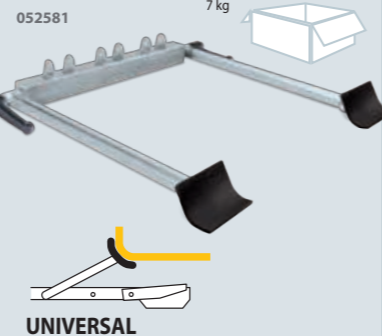

UNIVERSAL

SYSTÈME DE TIRAGE SMART PULLER SILVER

- Smart puller silver pulling system - Schnellausbeul-Richtausleger Smart puller silver

054820

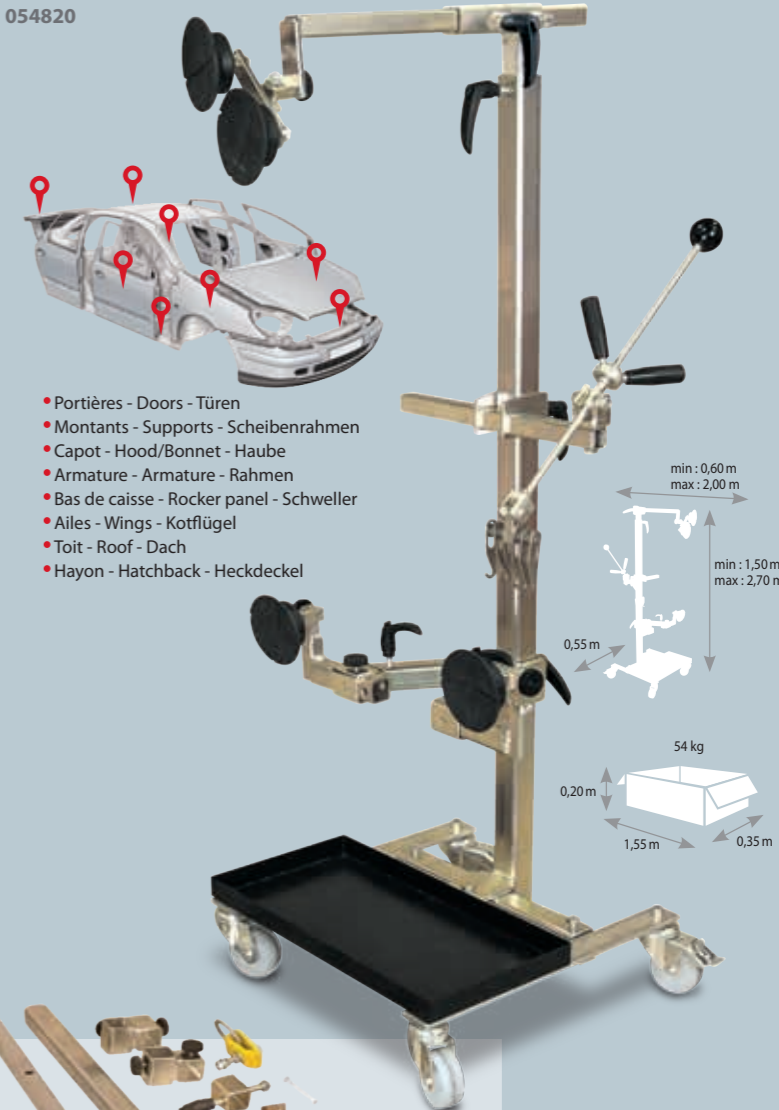
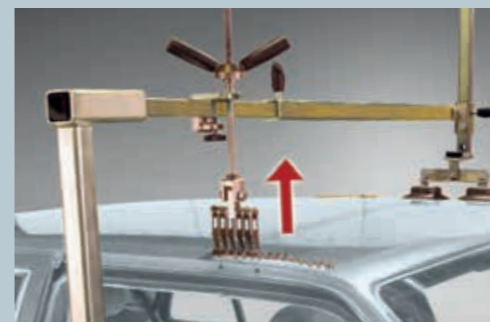

- Portières - Doors - Türen
- Montants - Supports - Scheibenrahmen
- Capot - Hood/Bonnet - Haube
- Armature - Armature - Rahmen
- Bas de caisse - Rocker panel - Schweller
- Ailes - Wings - Kotflügel
- Toit - Roof - Dach
- Hayon - Hatchback - Heckdeckel

INCLUDED  
Accessories

Autorobot

**Spreading / Estensione**

**Pressing / Compressione**

**Pulling / Tiro**

**Pushing / Spinta**

**Applications / Applicazioni**

**ELECTRO POWER** Non commercialisable en France

with accessories: 057425

- PULLING POWER: 5 Ton.  
- PUSHING POWER: 5 Ton.  
- PISTON STROKE: 130 mm

MADE IN ITALY

**INCLUDED**

Standard kit : 425x620x210 mm  
Standard kit Total weight: 18 Kg  
057401

Li-Ion battery (included)  
058514

Accessories kit : 425x620x150 mm  
Accessories kit Total weight: 20 Kg  
057418

**SATELLITE INTELLIGENT - Smart Satellite - Satellite Komplett-Kit**

The best from **Autorobot**  
www.autorobot.com/pdf/714B\_ENG.pdf  
MADE IN FINLAND



**PACK SATELLITE**

= 1 + 2 + 3 + 4 + 5 + 6  
052727



**1 SATELLITE**  
- Satellite - Satellite Basisbügel-Set



**2 KIT MAC PHERSON (A)**  
- Mac Pherson Kit - Befestigungskit-Federbein (McPherson)



**3 BARRE POUR TIRER/POUSSER**  
- Push/Pull Bar  
- Zug/Druck-Stangenset

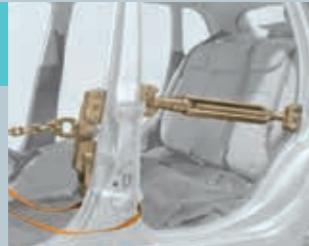

**4 SATELLITE (B)**  
- Bügelverlängerung



**5 SANGLE DE SÉCURITÉ**  
- Safety Strap - Sicherungsgurt



**6 DOUBLE PINCE SATELLITE (C)**  
- Double Clamp Satellite  
- Satellite Doppelklemme



**PINCE DE TIRAGE MULTI-USAGE**  
- Versatile pulling clamp  
- Multifunktions-Zugklemme



**KIT MARTEAU À INERTIE - Inertia hammer kit - Ausziehhammer kit**



**OUTILS DE TIRAGE - Frame Straightening - Ziehwerkzeuge**

Kit crochet de tirage « boomerang »  
- Boomerang pulling hook set  
- Zughaken Set «Boomerang»

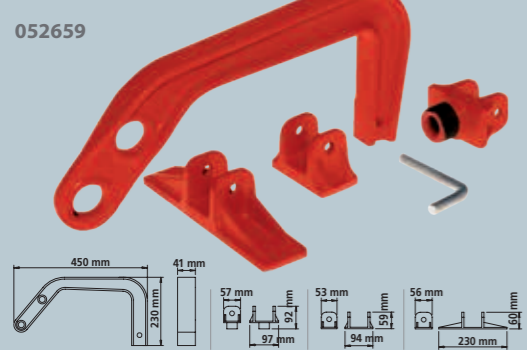

Pince de tirage à angle droit  
- Right angle pull clamp  
- Zugklemme 90° Winkel



Pince de tirage à blocage automatique  
- Self-locking pull clamp  
- Selbstklemmende Zugklemme

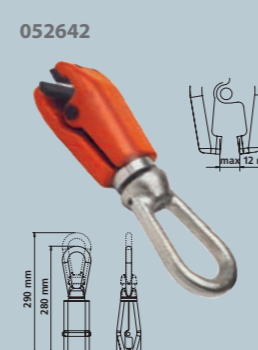

Mini pince de tirage à blocage manuel  
- Manual-locking pull clamp  
- Mini Klemme von Auflage in Handblockieren



**COFFRET VÉRIN HYDRAULIQUE - Hydraulic cylinder kit - Hydraulischer Drucksatz**

MADE IN P.R.C.

**BASIC 4T**  
052345



**BASIC 10T**  
052338

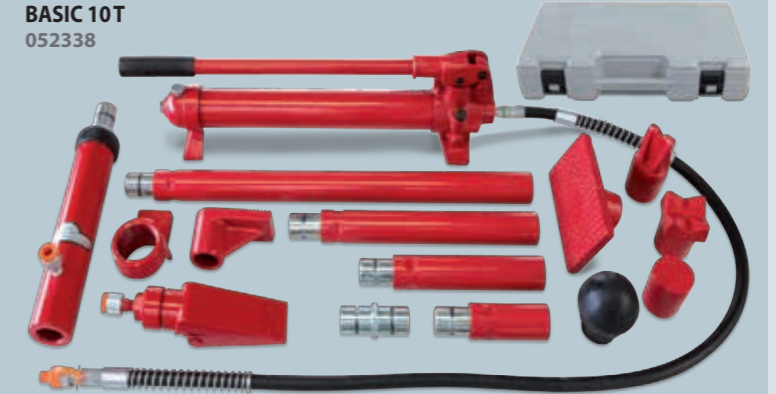

**PRO 4T**  
057432



**PRO 10T**  
057449



**BARRE D'ANCRAGE - Anchor bar - Türspanner**

MADE IN TAIWAN



**MESURES - Measuring tools - Vermessung**

**GYSMETER, Electronic measurements**

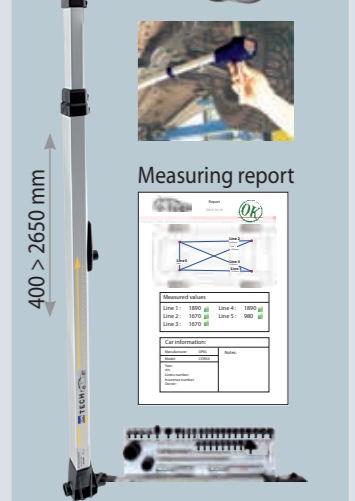

**RAIL SAVER**

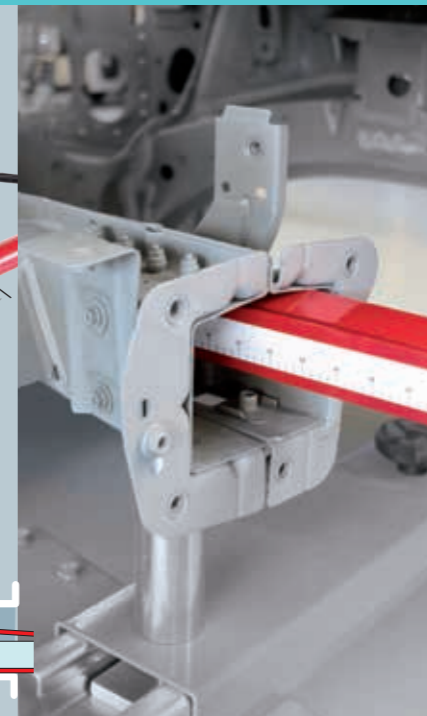

**BODYMETER, Mechanical Measurements**



**INDUCTEUR DÉBOSELAGE** - Dent Pulling Inductor - Ausbeul Induktor

Débosselage rapide et sans peinture  
- Fast paintless dent pulling  
- Lackschadenfreies Ausbeulen

**GYSDUCTION AUTO DENT REPAIR**

054981



MADE IN FRANCE



**Dent pulling inductor**

054776



Licensed by BETAG Innovation

**INSPECTION CARROSSERIE** - Dent Pulling Inductor - Ausbeul Induktor

Planche flexible pour inspection de la carrosserie  
Ø 800 mm  
059122

NEW 2018

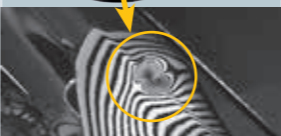

←	→	+	-	Freq.	INTEGRATED TECHNOLOGY	❄️	Cable (m)	↕️	⚖️	OPTION	
50 Hz	A	W	kHz	PFC	FV	Liquid Cooling	Inductor	cm	kg	Spray refroidisseur - Freezer spray -50°C 400 ml	
230V, 1~	16	2400	35+120	▪	▪	—	2	2,5	22 x 36 x 27	7,2	(x 12) 048898

**GLUE PULLER PRO** (Acier/Alu • Steel/Alu)



MADE IN FRANCE



**Glue Puller PRO**

058699

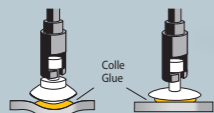

Glue Lifter

057364

**Glue Puller PRO EXPORT**

059160

x6

050952



Ø 16

Ø 21

Ø 32

250 W

052901



x10

050976



050983

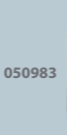

**BARRETTES ANNEAUX PLASTIQUE** - Plastic Multipads Ösen-Klebe pads

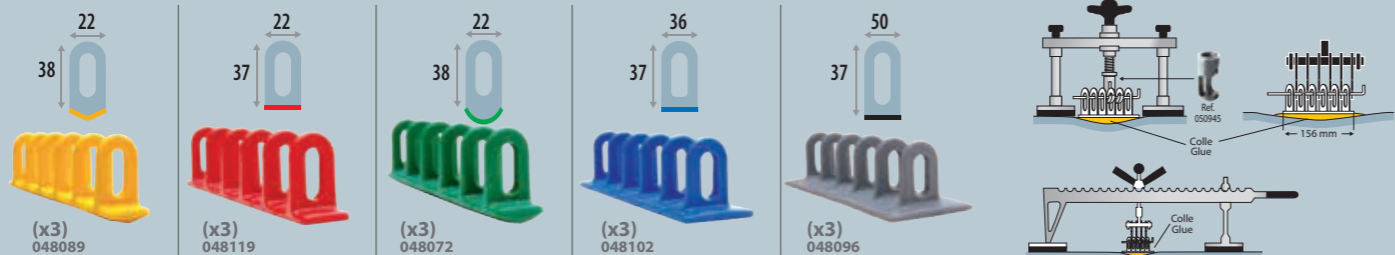

(x3) 048089

(x3) 048119

(x3) 048072

(x3) 048102

(x3) 048096

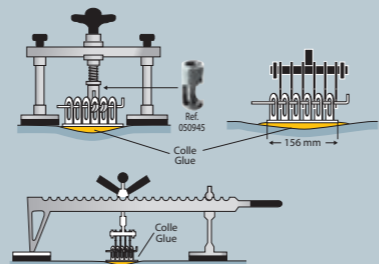

**OPTIONS**

Poignée de tirage 3 dents - Pulling handle 3 claws - Handzugkralle 3-fach  
057326



057302

Marteau à inertie 380 g - Slide hammer 380 g - Gleithammer 380 g  
050051

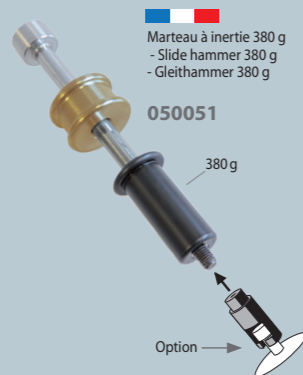

Option →

Marteau à inertie 500 g - Slide hammer 500 g - Gleithammer 500 g  
057906



acier-steel-Stahl 1.6 kg

Jeu de 2 couteaux pour découpe de renforts collés - Set of 2 knives to cut glued reinforcements - 2-er Set Messer zur Klebepadentfernung  
057913



**KIT MAGNÉTIQUE DE DÉBOSELAGE SANS PEINTURE** - Paintless Dent Repair magnetic kit - Magnetisches Ausbeul-Kit

053168

EXELTOOLS



1010 mm - 40"

705 mm - 28"

510 mm - 20"

610 mm - 24"

**LAMPES DE DÉBOSELAGE** - Paintless Dent Repair lamps - Ausbeullampe

056749

Made in Taiwan

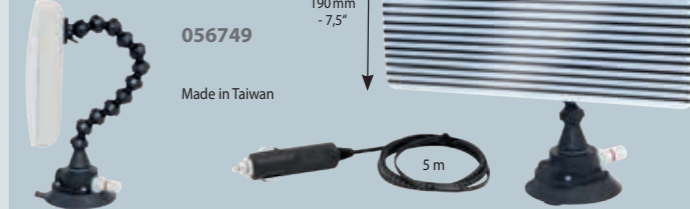

360 mm - 14"

190 mm - 7.5"

5 m

**ULTRA LIGHT CARBON X40 PW**

053175

EXELTOOLS



300 mm - 12"

150 mm - 6"

**KIT DÉBOSELAGE SANS PEINTURE** - Dent Pulling Kit (paintless) - Dellenausbeulhebel-Set

- Dent Pulling Kit (paintless) - Dellenausbeulhebel-Set



33 parts



051959



Paintless Dent Repair Kit

**KIT DE 6 COINS DE FRAPPE** - Set of 6 pencil punches - Beulenstemmer-Satz mit 6 Tefloneinsätzen

- Set of 6 pencil punches - Beulenstemmer-Satz mit 6 Tefloneinsätzen



052888



MADE IN FRANCE

**MARTEAU INERTIE PNEUMATIQUE** - Pneumatic inertia hammer - Unterdruck-Schlaghammer



2,5 kg

051904

Ø 60 (x1)

Ø 120 (x1)

Ø 150 (x1)

**KIT COUSSINS GONFLABLES** - Air Cushion Kit - Luftpolster-Spreizkissen-Satz

- Air Cushion Kit - Luftpolster-Spreizkissen-Satz



051942

**MARTEAU À INERTIE À VENTOUSES (POMPAGE MANUEL)** - PUMP AIR SUCTION SLIDE HAMMER - Man. Unterdruck-Schlaghammer



1,1 kg

Ø 75 (x1)

Ø 100 (x1)

Ø 125 (x1)

048683





### SPOT LIFT

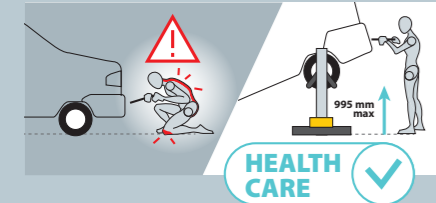
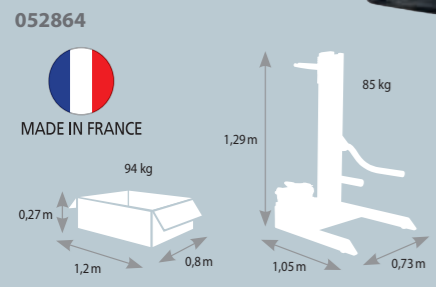

Haute stabilité - High stability

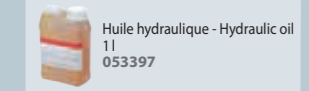
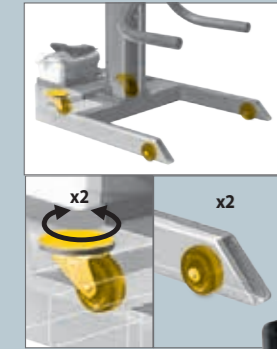

2,5 t max



OPTION  
Outil de levage pour bas de caisse  
- Rocker panel lifting tool  
- Auflage für Seitenschweller



### SPOT LIFT PRO

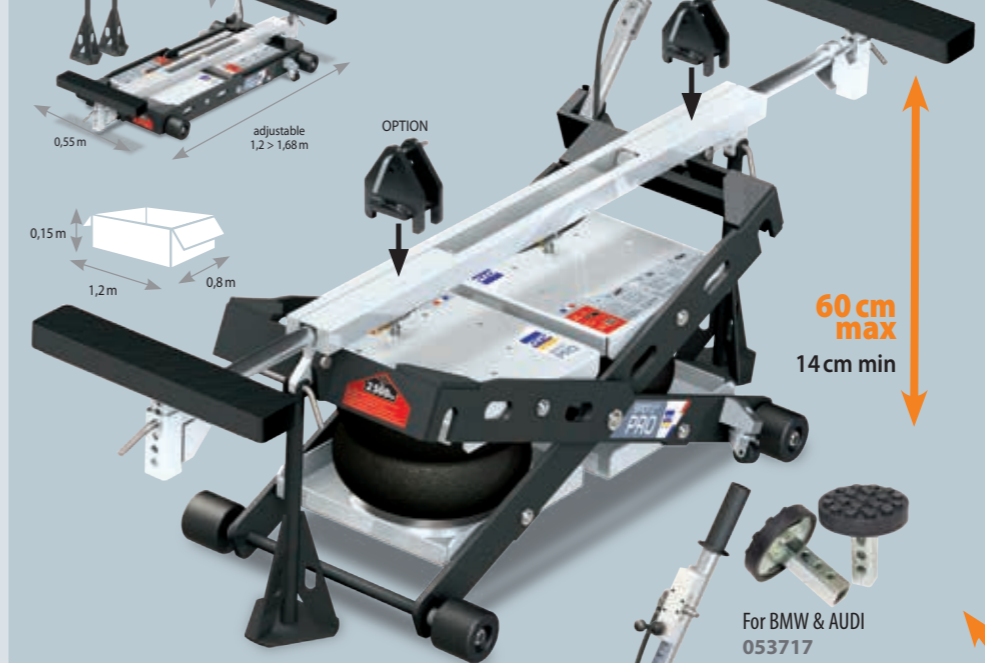
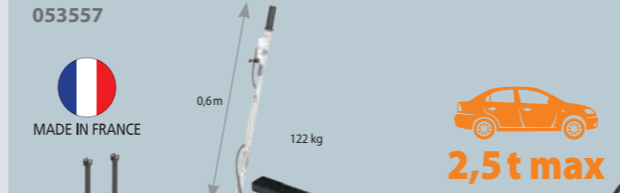

OPTION SPOT LIFT PRO  
Réhausseur pour 4x4 et utilitaires  
- Height adjuster for 4x4 & utility vehicles  
- Erhöhung f. 4x4 und Leicht-LKW



### SPOT LIFT PRO MOB

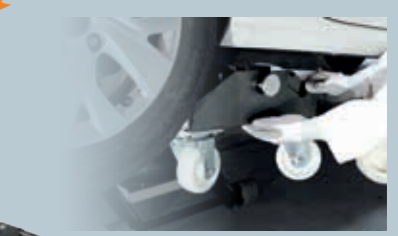
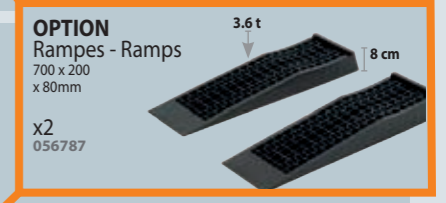
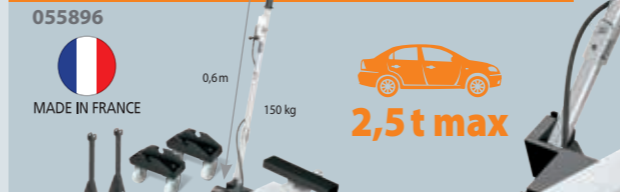

### AUTO ROLL 1.2T



### CHARIOT DE MANUTENTION PRISE SOUS ROUE

- Wheel truck - Kfz-Montagelift, fahrbar



### AIR JACK

MADE IN HIGH QUALITY ITALY



### TABOURETS DE MANUTENTION

- Wheel trolleys - Radhocker

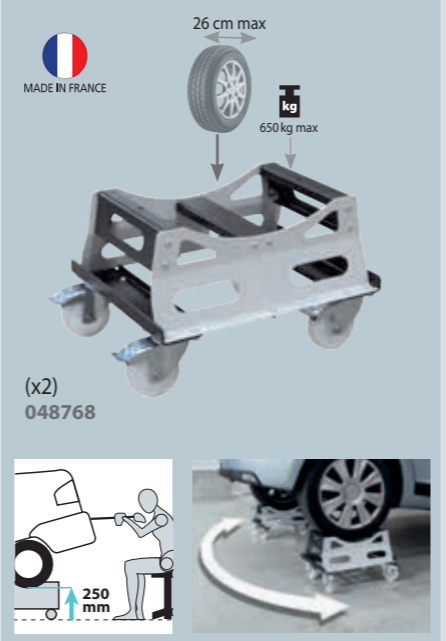



**PORTASPOT 230**

**6 300 A** 120 daN

Air cooled

230V  
022256



DELIVERED WITH PX 1



ARMS Ø 25 mm

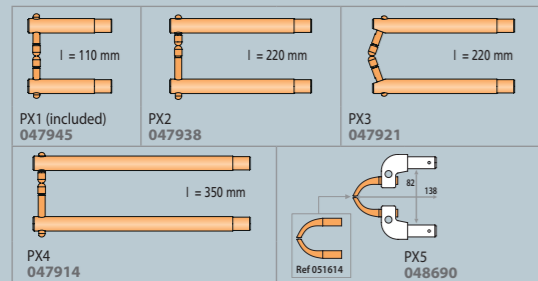

ELECTRODES

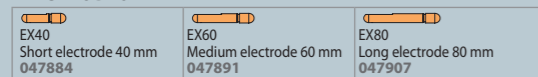

CAPS & ACCESSORIES

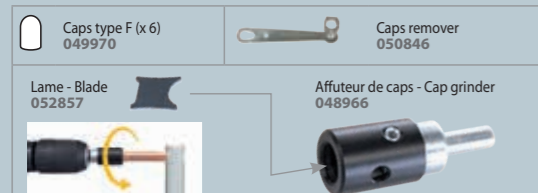

50/60 Hz	1 x 230V	A	A	A	mm	V	← m	Ø mm <sup>2</sup>	100% CU	(no arm) cm	kg
		16(D)	6 300	8 900	2+2	2,45	2,5	3x2,5 H05VVE	OK	36x29 x10	10

**GYSPOT 32D-X**

**7 500 A** 500 daN

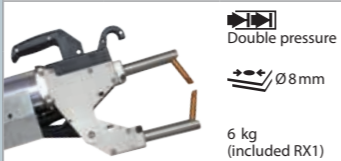

Air cooled

2 x 400V  
022850  
complete : 019881

**GYSPOT 32D-C**

**7 500 A** 300 daN

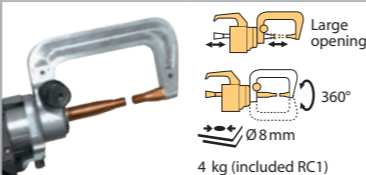

Air cooled

2 x 400V  
019898



**GYSPOT INVERTER 100R-X**

**10 000 A** 500 daN

For mild steel, HSS, UHSS



Air cooled

Traceability software  
Save spot welding configuration and export data

3 x 400V  
019911



**GYSPOT INVERTER 100R-C**

**10 000 A** 300 daN

For mild steel, HSS, UHSS

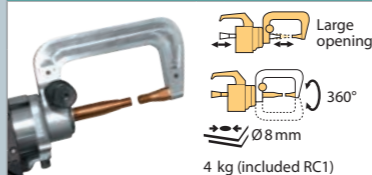

Air cooled

Traceability software  
Save spot welding configuration and export data

3 x 400V  
019928



**GYSPOT INVERTER 100R-CX**

**10 000 A** 500 daN (X)  
300 daN (C)

For mild steel, HSS, UHSS

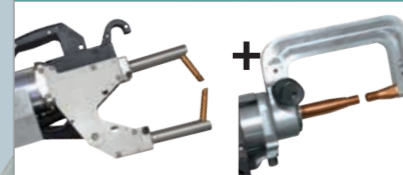

Air cooled

Traceability software  
Save spot welding configuration and export data

3 x 400V  
022317



OPTIONS



INCLUDED

	022850	022867	019881	019898	019911	019928	022317
<b>32D-X</b>	■	■	■	■	■	■	■
<b>OPTIONAL PACKAGE 32D-X</b>	■	■	■	■	■	■	■
<b>32D-X complete</b>	■	■	■	■	■	■	■
<b>32D-C</b>	■	■	■	■	■	■	■
<b>100R-X</b>	■	■	■	■	■	■	■
<b>100R-C</b>	■	■	■	■	■	■	■
<b>100R-CX</b>	■	■	■	■	■	■	■

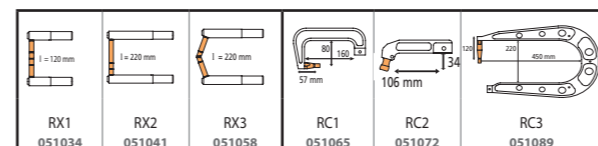

MADE IN FRANCE	62135	50/60 Hz	A	A	A	mm	U <sub>o</sub>	Cables	100% CU	cm	kg
<b>GYSPOT 32D.X</b> <b>GYSPOT 32D.C</b>	2 x 400V	32 (D)	7 500	10 500	3 + 3	1,2 + 3	11	Air Cooled	2,2	200	55 x 75 x 190
								2,5	150	100	
<b>GYSPOT 100R.X</b> <b>GYSPOT 100R.C</b> <b>GYSPOT 100R.CX</b>	3 x 400V	32 (D)	10 000	—	3 + 3 + 3	1,5 + 3	16	2,5	200	108	
								2,5	150	107	
								8	4 x 6 H07RNF	125	

# GYSPT INVERTER BP-LX

**13 000 A**  
550 daN

For mild steel, HSS, UHSS Boron steel

- Double pressure
- ∅ 10 mm
- 6,5 kg (included X1)

Liquid cooled

**BP BODYPROTECT**  
Unique electro-magnetic field protection by GYS

**Traceability software**  
Save spot welding configuration and export data



	019652	058804
	<b>400V</b>	
Monopoint/Spot 049291	▪	▪
Spotter box pro (p.15) 050075	▪	▪
Inertia hammer 049482 + 049802	▪	▪
X1 050501	▪	▪
X4A (x2) + X4B + X4C + X2 020733	▪	▪
CORAGARD CS 330 (10) 052246	▪	(x3)

# GYSPT INVERTER BP-LC-s7

**13 000 A**  
550 daN

For mild steel, HSS, UHSS Boron steel

- Double pressure
- ∅ 10 mm
- 6,5 kg (included C1)

Liquid cooled

**BP BODYPROTECT**  
Unique electro-magnetic field protection by GYS

**EDC Automatic C clamp**  
Energy Dynamic Control

**Traceability software**  
Save spot welding configuration and export data



	020757	058798
	<b>400V</b>	
Monopoint/Spot 049291	▪	▪
Spotter box pro (p.15) 050075	▪	▪
Inertia hammer 049482 + 049802	▪	▪
Contact grease 050440	▪	▪
Caps remover 050846	▪	▪
Arm panel	▪	▪
C1 019140	▪	▪
C2 + C3 + C4 019126	▪	▪
C6 019775	▪	▪
CORAGARD CS 330 (10) 052246	▪	(x3)

Included  
Support haute stabilité  
-High stability support  
Compatible gyro  
+

**OPTION**

**10-14 kg**  
GYRO 360\* for BP-LC  
051737

## OPTIONS

050068 x10 (x20: 052239) x18 (x6: 049987) x6 (x6: 049994) x18 (x6: 049970)	SD CARD 050914	CORAGARD CS 330 101 Liquide de refroidissement Cooling liquid Kühlmittel Enfriamento líquido Refrigeración líquida 052246	Houise de protection - Protection cover - Schutzhaube 050853
--	----------------	---	---

MADE IN FRANCE 62135	50/60 Hz	+AM+	RMS A	Uo V	mm		Cables			100 % CU	↕ cm	⚖ kg	
					↔	⊥	Liquid / Air Cooled	↔ m	∅ mm <sup>2</sup>				
<b>GYSPT BPLX</b>	3 x 400V	32 (D)	13000	16	3 + 3 + 3	1,5 + 3		Liquid	2,5	200	OK	65 x 80 x 205	160
<b>GYSPT BPLC-s7</b>								Air	2,5	150			



# GYSPT INVERTER BP-LQC-s7

**13 000 A**  
550 daN

For mild steel, HSS, UHSS **Boron steel**



Liquid cooled

**BP BODYPROTECT**  
Unique electro-magnetic field protection by GYS

**EDC Automatic C clamp**  
Energy Dynamic Control

**Traceability software**  
Save spot welding configuration and export data

	022713	021082	058774
Gyspot BP-LQC-s7	220V	400V	
Monopoint/Spot 049291			
Spotter box pro (p.15) 050075			
Inertia hammer 049482 + 049802			
Caps remover 050846			
Arm panel			
QC1 021167			
QC2 + QC3 + QC4 022065			
CORAGARD CS 330 (10) 052246			(x3)



Included  
Support haute stabilité  
-High stability support  
Compatible gyro  
+

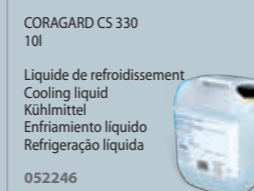

MADE IN FRANCE

## for : BP LQC **NEW GENERATION**

**550 daN** **6,5 kg** including C1

LIQUID COOLED  
REFROIDISSEMENT  
LIQUIDE Ø 10 mm

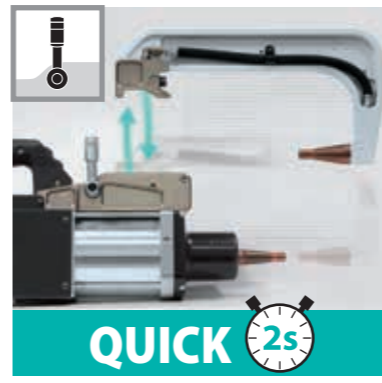
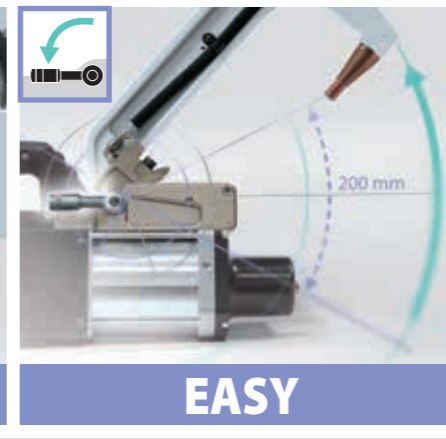
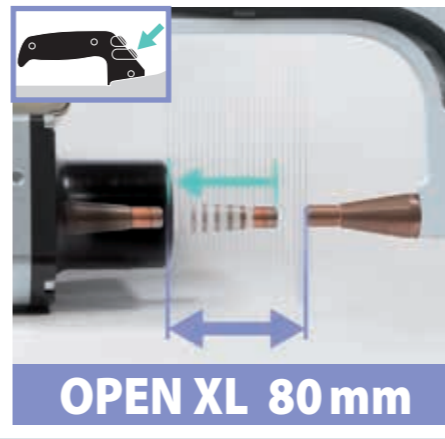

C Arms - Caps Ø13 mm

Bras isolés - Isolated arms - Isolierte Bügel

= Aluminium nickelé - Nickel plated aluminium - Aluminium (vernickelt)

 QC1 8 bar/550 daN 021167	 QC4 8 bar/550 daN 021228	 QC6 8 bar/550 daN 021259	 QC5 4 bar/150 daN 021235
 QC3 8 bar/300 daN 021204	 QC8 8 bar/550 daN 022751	 QC2 8 bar/550 daN 021181	 QC7 8 bar/550 daN 022072
 QC9 8 bar/550 daN 022874	 Arm panel QC2 + QC3 + QC4 022065		

GYSPT BP.LQC-s7	3 x 400V	32 (D)	13 000	16	Uo	mm	Cables				100% CU	cm	kg
							A	A	V	mm			
GYSPT BP.LQC-s7 220 V	3 x	63 (D)	10 500 11 000 12 000 12 500	15 15,5 17 18	3 + 3 + 3	1,5 + 3	2,5 m, Ø 200 mm <sup>2</sup> , Liquid	2,5 m, Ø 150 mm <sup>2</sup> , air	8 m, 4x6 H07RN-F (BP 220V: 4x6AWG)	OK	65 x 80 x 205	160	

# GYSPT SPOT INVERTER BP-LCX-s7

**13 000 A**  
550 daN

For mild steel, HSS, UHSS Boron steel



Double pressure  
Ø 10 mm  
6,5 kg  
(included X1 or C1)

Liquid cooled

**BP BODYPROTECT**  
Unique electro-magnetic field protection by GYS

**EDC Automatic C clamp**  
Energy Dynamic Control

**Traceability software**  
Save spot welding configuration and export data



GYRO 360° for BP-LCX  
051737  
10-14 kg



Included  
Support haute stabilité  
-High stability support  
Compatible gyro  
+

### OPTIONS

	050068		SD CARD 050914	CORAGARD CS 330 10l	Housse de protection - Protection cover - Schutzhaube for BP & PTI 050853
	x10 (x20: 052239)		x18 (x6: 049987)	Liquide de refroidissement Cooling liquid Kühlmittel	
	x6 (x6: 049994)		x18 (x6: 049970)	Enfriamento líquido Refrigeración líquida	
	048935		x40 (x6: 049987)		

# GYSPT SPOT INVERTER EVOLUTION PTI

**14 500 A**  
550 daN

For mild steel, HSS, UHSS Boron steel



FUSE  
16 > 25 A  
Double pressure  
Ø 10 mm  
10,5 kg  
(included C1)

**TRANSFORMER INSIDE**

Liquid cooled

**EDC Automatic C clamp**  
Energy Dynamic Control

**Traceability software**  
Save spot welding configuration and export data

**NEW DESIGN**  
  
Very light  
**10,5 kg**

	220V		400V	
	4M 022188	4M 020894	4M 058811	
Gyspot BP-LCX-s7				
Contact grease 050440				
Caps remover 050846				
Arm panel				
C1 021402				
C2 + C3 + C4 021457				
C6 019775				
Gyro 360° 051720				
Complete gun kit 051010				
CORAGARD CS 330 (10l) 052246				(x3)



	50/60 Hz	A	RMS	Uo	mm	Cables			100% CU	cm	kg		
						3+3+3	1,5+3	1,5+3					
<b>GYSPT BP.LCX-s7</b>	3 x 400V	32 (D)	13 000	16	3+3+3	1,5+3	2,5 m, Ø 200 mm <sup>2</sup> , liquid	2,5 m, Ø 150 mm <sup>2</sup> , air	8 m, 4x6 H07RNF (BP 220V: 4x6AWG)	OK	65 x 80 x 205	180	
<b>GYSPT BP.LCX-s7 220 V</b>	3 x	200 208 220 240	63 (D)	10 500 11 000 12 000 12 500	15 15,5 17 18								
<b>GYSPT EVOLUTION PTI-s7</b>	3 x 400V	25 (D) 16 (D)	14 500 11 500	8	3+3+3	1,5+3	4 m, liquid	6 m, liquid	OPTION 051010: 1,5 m, Ø 200 mm <sup>2</sup>	8 m, 4x4 H07RNF	OK	65 x 80 x 230	100
<b>GYSPT EVOLUTION PTI-s7 220 V</b>	3 x	200 208 220 240	40 (D) 14500A 32 (D) 14500A	6,95 7,2 8 8,3			4 m, liquid	6 m, liquid	8 m, 4xAWG8 (500W)				

INVERTER • LIQUID COOLED

for : 32DX • 100RX • 100RCX • BPLX • BPLCX

550 daN

6,5 kg including X1

- DOUBLE PRESSURE
- LIQUID COOLED / REFRIGÉREMENT LIQUIDE
- Ø 10 mm

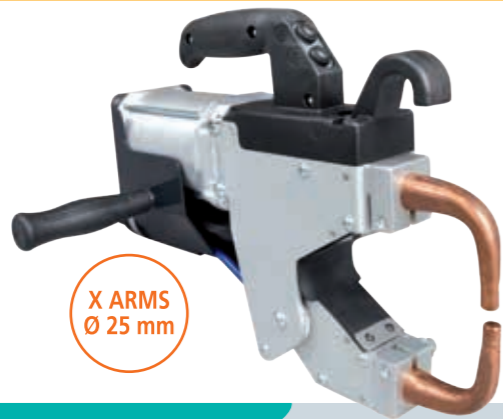

Remote control (BP)



Digital screen control  
Change Mode & Parameters



Clamp control



X Arms - Caps Ø13 mm

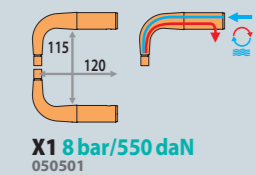

X1 8 bar/550 daN  
050501

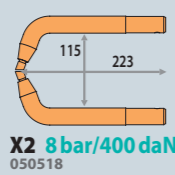

X2 8 bar/400 daN  
050518

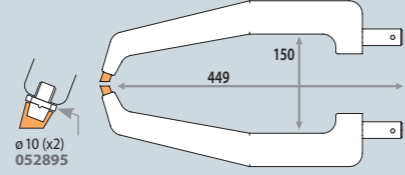

X4 8 bar/120 daN  
050532

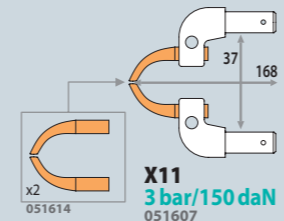

X11 3 bar/150 daN  
051607

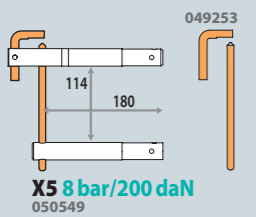

X5 8 bar/200 daN  
050549

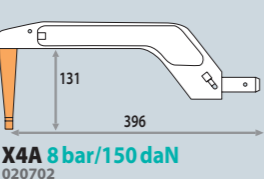

X4A 8 bar/150 daN  
020702

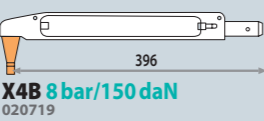

X4B 8 bar/150 daN  
020719

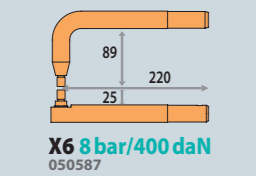

X6 8 bar/400 daN  
050587

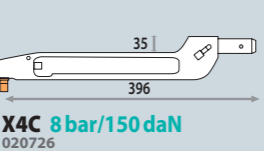

X4C 8 bar/150 daN  
020726

X4 (A, B & C) combinations

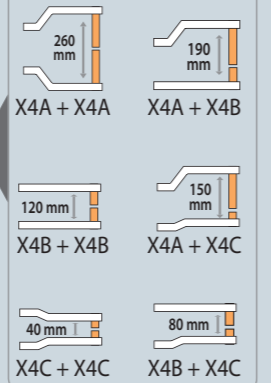

Arm panel

X4A (x2) + X5 + X2  
022324



X4A (x2) + X4B + X4C + X2  
020733

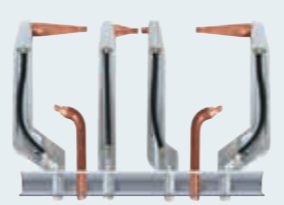

Consommables X & C - X & C Consumables

- Type A Cor X clamp Ø 13 mm (x6) 049987
- Type B Cor X clamp Ø 13 mm / Ø 5 mm (x6) 055506
- Type C X2, X4, C11 arms Ø 13 mm (x6) 049994
- Type D Cor X clamp Ø 13 mm (x10) 058507
- TYPE F For single sided gun Ø 13 mm (x6) 049970



Europax anti-corrosion 052758

Lame - Blade 052857



Affuteur de caps - Cap grinder 048966



GYRO 360°



10-14 kg  
for BPLC/BPLCX 051737



for EVOLUTION 051720

BANC DE TRACTION ARRACHE TÔLE - Steel sheet traction bench - Blech-Zugbank zur Festigkeitsprüfung



052420

052321 (included)

CAPEUR D'EFFORT - Electrode force sensor



ÉCHANTILLONS DE TÔLES - Sheets set

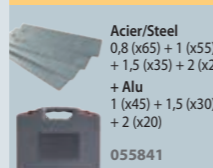

Acier/Steel 0,8 (x65) + 1 (x55) + 1,5 (x35) + 2 (x25) + Alu 1 (x45) + 1,5 (x30) + 2 (x20) 055841

GYSTEEL VISION

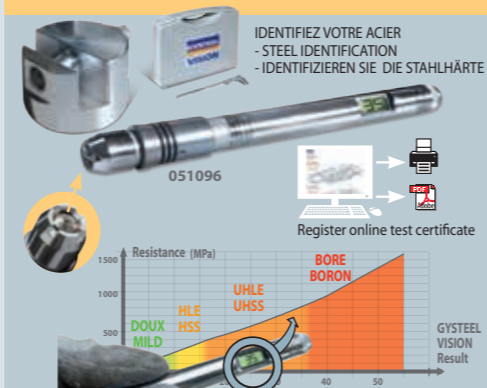

IDENTIFIEZ VOTRE ACIER - STEEL IDENTIFICATION - IDENTIFIZIEREN SIE DIE STAHLHÄRTE

051096 Register online test certificate

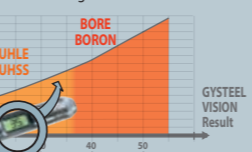

for : EVOLUTION PTI • BPLCX • BPLC

550 daN

6,5 kg including C1

- DOUBLE PRESSURE
- LIQUID COOLED / REFRIGÉREMENT LIQUIDE
- Ø 10 mm



550 daN

Transformer inside

10,5 kg including C1

- DOUBLE PRESSURE
- AIR COOLED + LIQUID COOLED / DOUBLE REFRIGÉREMENT AIR + LIQUID
- Ø 10 mm

C Arms - Caps Ø13 mm

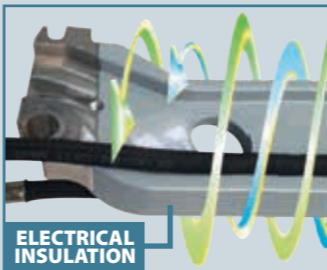

ELECTRICAL INSULATION

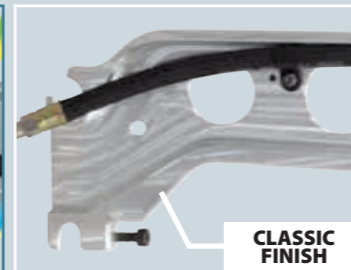

CLASSIC FINISH

Remote control (BP)

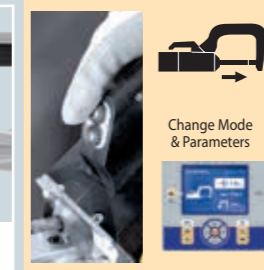

Change Mode & Parameters



Arm panel



C2 + C3 + C4 019126

C2 + C3 + C5 + C6 + C9 050044



C2 + C3 + C4 021457



Bras isolés - Isolated arms - Isolierte Bügel & Classic arms

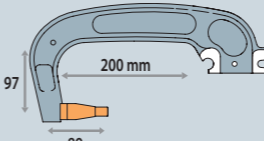

C1 8 bar/550 daN

021402 019140

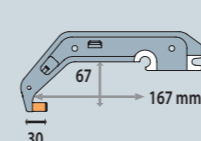

C5 8 bar/550 daN

022393 019294

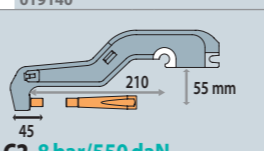

C2 8 bar/550 daN

022386 019133

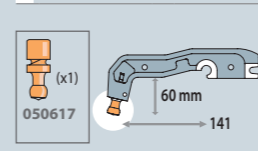

C6 8 bar/300 daN

022409 019775

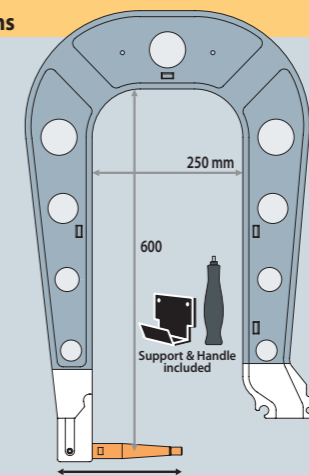

C9 8 bar/550 daN

020078



C3 8 bar/550 daN

021419 019157

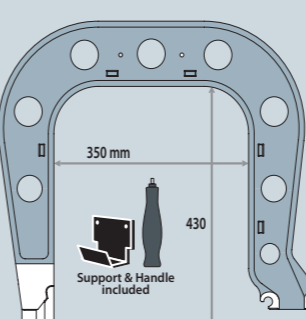

C7 8 bar/550 daN

021433 020009

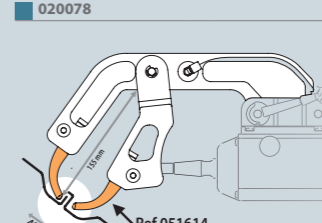

C10 4 bar/150 daN

051638

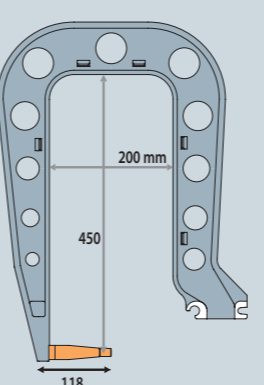

C4 8 bar/550 daN

021426 019164

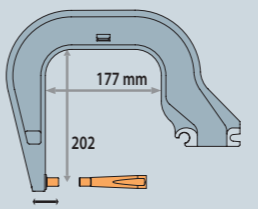

C8 8 bar/550 daN

021440 020016

X Arms - Caps Ø13 mm

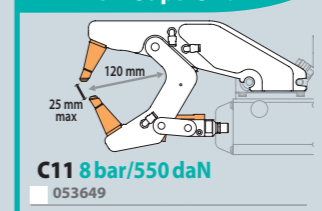

X11 8 bar/550 daN

053649

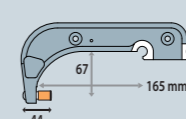

C12 8 bar/550 daN

022997 023000

KIT DE PURGE RÉSERVOIR - Tank draining kit - Kit zur Tankentleerung



058286

VALISE DE TEST SOUDURE - Weld test kit - Schweißtestkit im Hartschalenkoffer



050433

Tôle/Sheet/Schweißprobenbleche HLE / HTS 1.0mm (x150) 050181 2.5 mm (x150) 050167

# UNIVERSAL CAR BODY RIVETING SYSTEMS

## 8t PNEUMATIC HYDRAULIC

(7840 daN)

### GYPRESS 8T

053861



**UNIQUE**  
100%  
**No Oil Leak**  
maintenance free, no oil refill



#### INCLUDED

	Standard 8T tool box (2 clés + centreur inclus) (2 keys + special center punch included) 053694
	HR15 054219
	for HR15 & HR2 057111
	HR arm locker
	Strap - Sangle - Gurt
	Poignée - Handle - Griff
	6 x 50 rivets - Nieten <b>RAP/SPR</b> ACIER / STEEL / STAHL 048706 Ø 3,3 x 3,5 mm    Ø 5,3 x 4,0 mm Ø 3,3 x 4,0 mm    Ø 5,3 x 5,0 mm Ø 5,3 x 6,0 mm    Ø 5,3 x 8,0 mm

Discover it on Youtube



**RENAULT**  
77 11 382 905  
www.renault-equipment.com



### Unique Push Pull system by GYS

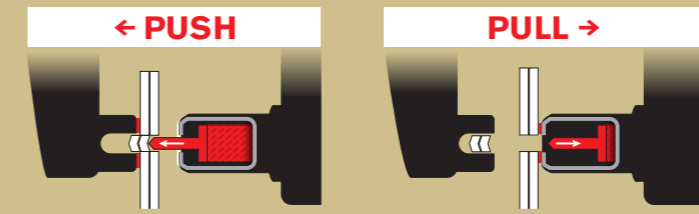

Discover it on Youtube



### GYPRESS 8T PUSH PULL

056893



**UNIQUE**  
100%  
**No Oil Leak**  
maintenance free, no oil refill



#### INCLUDED

	Standard 8T PushPull tool box (2 clés + centreur inclus) (2 keys + special center punch included) 058361
	HR15 054219
	for HR15 & HR2 058644
	HR arm locker
	Strap - Sangle - Gurt
	Poignée - Handle - Griff
	6 x 50 rivets - Nieten <b>RAP/SPR</b> ACIER / STEEL / STAHL 048706 Ø 3,3 x 3,5 mm    Ø 5,3 x 4,0 mm Ø 3,3 x 4,0 mm    Ø 5,3 x 5,0 mm Ø 5,3 x 6,0 mm    Ø 5,3 x 8,0 mm

#### CONTRÔLE DE LA PRESSION - Pressure control - Druckregelung

#### CONTRÔLE DE LA PRESSION - Pressure control - Druckregelung



#### CONTRÔLE DE LA VITESSE - Speed control - Regelung Werkzeuggeschwindigkeit



#### DISCHARGE LEVER - Auslösehebel

#### CONTRÔLE DE LA VITESSE - Speed control - Regelung Werkzeuggeschwindigkeit



#### SÉLECTION PUSH/PULL - Push/Pull selection

	AIR BAR	PRESSURE CONTROL	SPEED CONTROL	cm	kg	cm	kg
<b>GYPRESS 8T</b>	8 bar = 8 t (maxi 10 bar)	0 > 8 bar	+ -	38 x 140	5 (HR15 included)	58 x 48 x 15	10
<b>GYPRESS 8T PUSH PULL</b>	8 bar = 8 t (maxi 10 bar)	0 > 8 bar	+ -	39.5 x 180	5.8 (HR15 included)	58 x 48 x 15	10.8



### KIT MATRICES - Dies tool box - Matrizen-Kit

<p>Pose de rivets auto-perçants - Application of self-piercing rivets - Stanzniet-Verpressen</p> <p>2.0 &lt; 6.5 mm</p>	<p>Pose de rivets pleins - Application of solid rivets - Vollniet-Verpressen</p> <p>2.3 &lt; 8.3 mm</p>	<p>Pose de rivets Flow-Form - Application of flow-form rivets - Setzen v. Fließformnieten</p> <p>2.3 &lt; 8.3 mm</p>	<p>Extraction de rivets auto-perçants - Extraction of self-piercing rivets - Stanzniet-Auspressen</p> <p>2.3 &lt; 8.3 mm</p>	<p>Perçage et formage des tôles pour rivets pleins - Metal sheet punching and shaping - Vollniet-Lochstanzen/Prägen</p> <p>2.3 &lt; 8.3 mm</p>
---	---	--	--	--

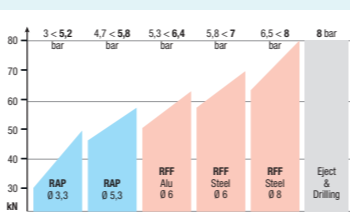

### STANDARD 8T

Included in GYSPRESS 8T  
053694



clés plate x2 joints x4

<b>A1</b> 055698 A1 + A2 set 054295	<b>A2</b> 055704	<b>B1</b> 055711 B1 + B2 set 054301	<b>B2</b> 055728	<b>E1</b> 055865 (x5) 054288	<b>E2</b> 055766 E1 + E2 set 054318
<b>F1</b> 055773 F1 + F2 set 054714	<b>F2</b> 055780	<b>D17</b> 055681	<b>D17</b> 055681	Applanissement des tôles - Metal sheet levelling - Blech-Rückverformung	
<b>T1</b> 057098 T1 x 5 059078		<b>T2</b> 057104 T1 + T2 set 054707		<b>Pointeau centreur</b> - Special center punch - Spezialkörner 048379	

### STANDARD 8T PUSH PULL

Included in GYSPRESS 8T Push Pull  
058361



clés plate x2 joints x4

<b>A1</b> 055698 A1 + A2 set 054295	<b>A2</b> 055704	<b>B1</b> 055711 B1 + B2 set 054301	<b>B2</b> 055728	<b>E1</b> 055865 (x5) 054288	<b>E2</b> 055766 E1 + E2 set 054318
<b>F1</b> 055773 F1 + F2 set 054714	<b>F2</b> 055780	<b>D17</b> 055681	<b>D17</b> 055681	Applanissement des tôles - Metal sheet levelling - Blech-Rückverformung	
<b>T7</b> 058033		<b>ST1</b> 058071		<b>T5</b> 058019	

### RMB 01

For BMW  
054240



<b>A1</b> 055698 A1 + A2 set 054295	<b>A2</b> 055704	<b>B1</b> 055711 B1 + B2 set 054301	<b>B2</b> 055728	<b>E1</b> 055865 (x5) 054288	<b>E2</b> 055766 E1 + E2 set 054318
<b>clés plate x2 joints x4</b>					

### RMB 02

For Jaguar/ Land Rover  
054271



<b>B3</b> 055735	<b>B2</b> 055728	<b>E1</b> 055865	<b>E6</b> 057142	<b>D17</b> 055681	<b>D17</b> 055681
<b>clés plate x2 joints x4</b>		Applanissement des tôles - Metal sheet levelling - Blech-Rückverformung			

### RMB 03

For VW Group  
054257



<b>A1</b> 055698	<b>S3</b> 057043	<b>B1</b> 055711	<b>S7</b> 057074	<b>S8</b> 057081
<b>D8</b> 056039	<b>D9</b> 056046	<b>D17</b> 055681	<b>D8</b> 056039	<b>D17</b> 055681
<b>D2</b> 055988	<b>S1</b> 057036	<b>D1</b> 055971	<b>D3</b> 055995	<b>D4</b> 055742
<b>S4</b> 057050	<b>E2</b> 055766	<b>D13</b> 055759	<b>S5</b> 057067	
<b>D10</b> 055674	<b>D11</b> 056060	<b>D15</b> 056077	<b>D16</b> 056084	<b>D6</b> 056015
<b>D7</b> 056022	<b>D12</b> 056053	<b>D5</b> 056008	pour bouchonnage	

### RMB 04

For Mercedes-Benz  
054264



clés plate x2

### RMB PP01

For Mercedes-Benz  
058378



clés plate x2

<b>E9</b> 058606	<b>E10</b> 058613	<b>E11</b> 058620	for HR3 arms (use with E9, E10, E11) 057135
<b>F1</b> 055773 F1 + F2 set 054714	<b>F2</b> 055780	<b>F4</b> 055803	<b>F3</b> 055797 Rivets : S28/38/48/58/68
<b>F5</b> 055810 Rivets : S08/18			

### RMB 05

For Ford  
055872



clés plate x2

joints x4

### RMB 06

For Ferrari  
059009



clés plate x2

joints x4

### RMB PP02

For Ford  
058835



clés plate x2

joints x4

### RMB PP03

For Tesla  
059092



clés plate x2

joints x4

<b>B1</b> 055711	<b>G1</b> 057173	<b>G2</b> 057180	<b>G3</b> 057197	<b>G4</b> 057203	<b>G5</b> 057210	<b>G6</b> 057227
<b>E7</b> 057159	<b>E8</b> 057166					
<b>B4</b> 059016	<b>S3</b> 057043	<b>B5</b> 059023	<b>S7</b> 057074	<b>B6</b> 059030	<b>S8</b> 057081	
<b>E1</b> 055865	<b>E2</b> 055766	<b>E13</b> 059085	<b>D17 x2</b> 055681			
<b>B1</b> 055711	<b>G1</b> 057173	<b>G2</b> 057180	<b>G3</b> 057197	<b>G4</b> 057203	<b>G5</b> 057210	<b>G6</b> 057227
<b>E7</b> 057159	<b>E12</b> 058828					
<b>B1</b> 055711	<b>S7</b> 057074	<b>S8</b> 057081	<b>F4</b> 055803	<b>F3</b> 055797 Rivets : S28/38/48/58/68	<b>F5</b> 055810 Rivets : S08/18	
<b>T10</b> 058064	<b>ST2</b> 058088	<b>T9</b> 058057	<b>T8</b> 058040			
<b>E3</b> 057005	<b>E2</b> 055766	<b>E9</b> 058606	<b>E10</b> 058613	<b>D17 x2</b> 055681	for HR3 arm (use with E3, E4, E5) 057135	



**GYPRESS COMPLETE PACKS**



GYPRESS 8T		053861						055391	
pack GYPRESS 8T 058675	•	HR arm locker + Strap - Sangle - Gurt + Poignée - Handle - Griff	Standard 8T tool box 053694	6 x 50 rivets - Nieten RAP/SPR Acier/Steel/Stahl 048706	HR1S 054219	HR2 053878	HR3 053885	Support - Supportständer ↳ 28 x 40 x 21,5 cm 054158	Chariot-Trolley ↳ 51 x 82 x 74 cm 054233

GYPRESS 8T PUSH PULL		056893						055391	
pack GYPRESS 8T PUSH PULL 058682	•	HR arm locker + Strap - Sangle - Gurt + Poignée - Handle - Griff	Standard 8T Push Pull tool box 058361	6 x 50 rivets - Nieten RAP/SPR Acier/Steel/Stahl 048706	HR1S 054219	HR2 053878	PP HR3 058903	Support - Supportständer ↳ 28 x 40 x 21,5 cm 054158	Chariot-Trolley ↳ 51 x 82 x 74 cm 054233

**RIVETS AUTOPERÇANTS (RAP) - Self piercing rivets (SPR) - Stanznieten**

Steel - Acier - Stahl

Complete box	048706							
Ø 3.3 x 3.5 mm x 200	Ø 3.3 x 4 mm x 200	Ø 5.3 x 4 mm x 100	Ø 5.3 x 5 mm x 100	Ø 5.3 x 6 mm x 100	Ø 5.3 x 8 mm x 100	Ø 5.3 x 7 mm x 100	Ø 5.3 x 9 mm x 100	
048232	048249	048256	048263	048270	048225	048638	048645	

**BRAS DE RIVETAGE (HR) - Riveting arms (HR) - C-Bügel**

Gyspress 8t	<b>HR1S</b> 054219	<b>HR2</b> 053878	for HR1S & HR2 057111	<b>HR3</b> 053885	for HR3 057128	<b>KIT HR2 + HR3</b> 053892
Gyspress 8t Push Pull			058644	<b>PP HR3</b> 058903	for PP HR3 058637	<b>KIT PP HR2 + HR3</b> 058910

**CHARIOT - Trolley**

Support Riveteuse pour changements d'accessoires (bras & matrice)  
- Riveting machine support for changing accessories (arms & dies)  
- Supportständer  
↳ 28 x 40 x 21,5 cm  
054158

Chariot-Trolley  
↳ 51 x 82 x 74 cm  
054233

Chariot+Support  
-Trolley+Support  
↳ 51 x 122 x 74 cm  
055391

**PISTOLET À COLLE SANS FIL - Cordless caulking glue gun - Akku-Kartuschenpresse**

057975

Speed : > 10 mm/s  
Capacity : 400 ml  
14.4V - 2 Ah Li-ion battery  
2.75 kg  
↳ 465 x 130 x 275 mm  
↳ 535 x 305 x 156 mm

53528

**SERTISSEUSE HYDRO-PNEUMATIQUE RIV 998 - Hydropneumatic tool for rivet nuts - Hydro-pneum. Blindnietmuttergerät**

**RIV 998**

Ecrous à sertir  
- Sealing nuts  
- Blindnietmutter

Pour la pose d'écrous à sertir M4 à M12  
**max 19 000 N (6 bar)**  
livré avec accessoires pour écrous à sertir M4 à M12

055414

MADE IN ITALY

**GYPRESS 8T ET PUSH PULL : ADAPTEUR 20kN POUR RIVETS AVEUGLES - BLIND RIVET ADAPTER 20kN**

max 20 kN (8 bar)  
1.5 kg  
059214

HIGH ACCESSIBILITY

90°

90°

360°

140mm

104 mm / Ø 37mm

SPECIFIC STORAGE

NEW 03/2018

Rivets POP - BLIND rivets - Blindniet  
ALU Ø 4.0 / 7.8  
ACIER Ø 4.0 / 6.4

For standard rivets included (x1)  
Ø 3.2 059221  
Ø 3.6 059238  
Ø 4.0 059245  
Ø 4.5 059252

included (x3)  
058446

Rivets RIBE - RIBE BLIND rivets - Blindniet

**RIVETEUSE HYDRO-PNEUMATIQUE - Hydropneumatic tool for blind rivets - Hydro-pneum. Blindnietgerät**

**HR9** Rivets POP - BLIND rivets - Blindniet  
Pour rivets  
Ø 3,2/4,0/4,8 mm  
(Acier/Alu - Steel/Alu)  
**max 9 000 N**  
057234  
Made in Taiwan

**HR14** Rivets POP - BLIND rivets - Blindniet  
Pour rivets  
Ø 4,0/4,8/6,4 mm  
(Acier/Alu - Steel/Alu)  
**max 14 000 N**  
057241  
Made in Taiwan

**RIVETEUSE HYDRO-PNEUMATIQUE - Hydropneumatic tool for blind rivets - Hydro-pneum. Blindnietgerät**

**HR21** Rivets POP - BLIND rivets - Blindniet  
Pour la pose de rivets de structure  
**max 21 000 N (6 bar)**  
livré avec kit pour pose de rivets Ø 4.8 à Ø 7,8 mm

055407

included (x3)  
058446

For standard rivets  
058448

For Magnarive rivets  
058447

MADE IN ITALY

**MINI RIVETEUSE SANS FIL - Cordless riveter - Akku-Blindnietgerät**

Pour rivets  
Ø 3.2 & Ø 4.0 mm  
(Ø 4.8 mm alu)  
10.8V - 2 Ah Li-ion battery  
1.16 kg  
057968

Contrôle variable de la vitesse-Balais remplaçables.  
↳ 247 x 52 x 190 mm  
↳ 345 x 280 x 90 mm

Variable speed switch

Replaceable carbon brush

53525

**15 A → 200 A**  
Ideal 0,6 mm

**CAPACITOR INSIDE → PERFECT WELD**  
M1GYS AUTO, M3GYS AUTO

**ENERGY SAVING**

**CARMIG** 400V 3~



**TORCHE MOTORISÉE SPOOL GUN - Spool Gun Torch**  
- Spool Gun Brenner



041486

Ø 100

Ideal for  
- Acier / Steel / Stahl  
- Inox / Stainless steel  
- Alu



**M1GYS AUTO** 230V 1~ **CAPACITOR INSIDE**

with accessories:

230V 1~ 032903

208/240V 1~ 032088

**T1GYS AUTO** 400V 3~

with accessories:

032910

**T1GYS AUTO DV** 230V 3~/400V 3~

with accessories:

032927



**OPTIONS**

**MB 15 (150A)** 041226

**OPTIMAPRO** 30L/min (FR) 041998 (UK) 040274 (NL) 040267 (IT) 038691

**30L/min** (FR) 043619 (UK) 043626 (DE) 043633 (NL) 043640

**30L/min** (FR) 041622 (UK) 041646 (DE) 041219 (NL) 041615 (IT) 038707

041332

**T3GYS & M3GYS:** Housse de protection - Protection cover - Schutzhaube

052260

041806



**M3GYS AUTO** 230V 1~ **CAPACITOR INSIDE**

with accessories:

230V 1~ 032880

208/240V 1~ 032897

**T3GYS AUTO** 400V 3~

with accessories:

032958 032941

**T3GYS AUTO DV** 230V 3~/400V 3~

with accessories:

032972

**100% READY**

Ø 100 mm  
+  
Ø 200 mm  
+  
Ø 300 mm / 200 mm



**Protection gas**  
Argon+Co (Steel, Inox)  
Argon (ALU/CuSi3/CuAl8)  
Co\_PUR

MADE IN GYS CHINA	CARMIG	50/60 Hz	A	A	Reg	100 (spoolgun)	200	300	Electronic Control	EN60974-1 (40°C)	IA (60%)	X% (I2.max)	Ø mm	cm/kg	5 kVA	
		10	15+200	7	-	-	electronic	110	150A@25%	0,6+1	0,6/0,8	0,8	47x77x79 / 50			
MADE IN FRANCE	<b>M1GYS AUTO</b>	230V 1~	16	15+160	6	option	-	-	400V 3~	90	140A@15%	0,6+1	0,6/0,8	0,8	47x77x79 / 50	4,5 kVA
	<b>T1GYS AUTO</b>	208/240V 1~	10	15+200	7	option	-	-	400V 3~	110	150A@25%	0,6+1	0,6/0,8	0,8	47x77x79 / 55	5 kVA
	<b>T1GYS AUTO DV</b>	230V 3~/400V 3~	10	15+200	7	option	-	-	400V 3~	110	150A@25%	0,6+1	0,6/0,8	0,8	47x77x79 / 55	5 kVA
	<b>M3GYS AUTO</b>	230V 1~	16	15+160	6	-	-	-	400V 3~	90	140A@15%	0,6+1	0,6/0,8 0,8/1,0	2 x 0,8	60x90x90 / 67	4,5 kVA
	<b>T3GYS AUTO</b>	208/240V 1~	10	15+200	7	-	-	-	400V 3~	110	150A@25%	0,6+1	0,6/0,8 0,8/1,0	2 x 0,8	60x90x90 / 72	5 kVA
	<b>T3GYS AUTO DV</b>	230V 3~/400V 3~	10	15+200	7	-	-	-	400V 3~	110	150A@25%	0,6+1	0,6/0,8 0,8/1,0	2 x 0,8	60x90x90 / 72	5 kVA

# MIG/MAG

## INVERTER • PEARL

### 1 2 MIG / MANUAL



Adjust Spot & Delay

### 3 MMA



HotStart ArcForce

### 4 TIG lift



Post Gas Downslope

## SYNERGIC • EASY TO USE

### MIG / SYNERGIC

Easy to use

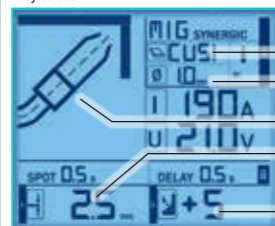

Select:

1. material
2. Ø wire
3. position
4. thickness

Adjust arc length

### MIG / SYNERGIC

Materials:

Fe	CrNi
AlMg5	CuSi3
AISI5	AISI12
CuAl8	F.C.

**4 in 1**

- GAS
- NO GAS
- MMA
- TIG

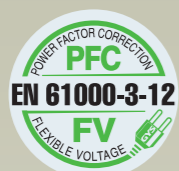
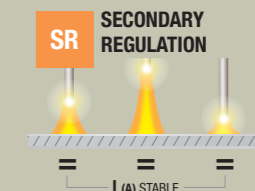
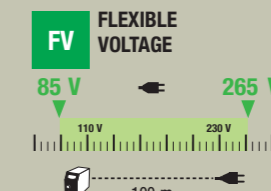
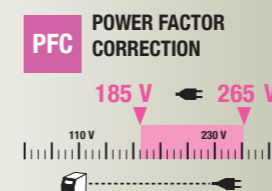

230V 1~

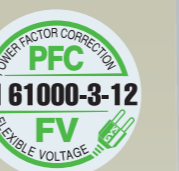
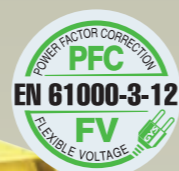

**PFC FV SR MMA GAS NO GAS TIG**

**Multi PEARL 200-2**

20▲200 A

Ø 100/200

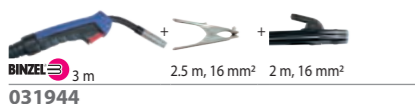

**PFC FV SR MMA GAS NO GAS TIG**

**Multi PEARL 200-4 XL**

20▲200 A

Ø 200/300

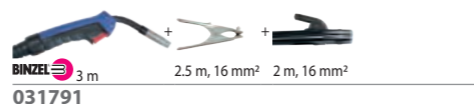

**PFC FV SR MMA GAS NO GAS TIG**

**Multi PEARL 201-4**

20▲200 A

Ø 200/300

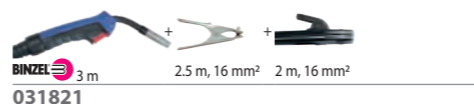

### OPTIONS

	<b>TIG TORCH KIT SR17V (valve)</b> 4 m 10/25 mm <sup>2</sup> 044425
	<b>WELD 610</b> 574 x 618 x 386 mm 040281
	<b>KIT SOUDAGE NO GAZ Ø 0.9</b> - No Gas Welding Kit Ø 0.9 - Schweißset Fülldraht 041240
	<b>TIG TORCH KIT SR17 DB</b> 4 m 046108

MADE IN FRANCE EN60974-1	50/60 Hz	A	I <sub>2</sub> MMA	I <sub>2</sub> TIG	EN60974-1 (40°C)		MIG			Ø mm			Ø mm		Equipment d'origine Original equipment Equipement de fabrica	TYPE p.52	cm	kg	Protected & compatible power generator (+/-15%)		
					IA (60%)	X% (I <sub>2</sub> max)	U <sub>0</sub> (V)	Electronic Control	m/min	100	200	300	GAS	NO GAS						MMA	
<b>Multi PEARL 200-2</b>	110V 1~	32	10+130	10+180	20+150	110	150 A @ 22%	85	15	■	■	—	0.6+1.0	0.9+1.2	1.6+3.2	0.6/0.8	A-042339	0.8	45 x 35 x 25	16	7.5 kW
	230V 1~	13	10+200	10+200	20+200	135	200 A @ 20%	85	15	■	■	—	0.6+1.0	0.9+1.2	1.6+5.0	0.6/0.8	B-042353	0.8	55 x 44 x 25	20	7.5 kW
<b>Multi PEARL 200-4 XL</b>	110V 1~	32	10+130	10+180	20+150	110	150 A @ 22%	85	15	—	■	■	0.6+1.0	0.9+1.2	1.6+3.2	0.6/0.8	B-042353	0.8	55 x 44 x 25	20	7.5 kW
	230V 1~	13	10+200	10+200	20+200	135	200 A @ 20%	85	15	—	■	■	0.6+1.0	0.9+1.2	1.6+5.0	0.6/0.8	B-042353	0.8	71 x 74 x 41	27	7.5 kW
<b>Multi PEARL 201-4</b>	110V 1~	32	10+130	10+180	20+150	110	150 A @ 22%	85	15	—	■	■	0.6+1.0	0.9+1.2	1.6+3.2	0.6/0.8	B-042353	0.8	71 x 74 x 41	27	7.5 kW
	230V 1~	13	10+200	10+200	20+200	135	200 A @ 20%	85	15	—	■	■	0.6+1.0	0.9+1.2	1.6+5.0	0.6/0.8	B-042353	0.8	71 x 74 x 41	27	7.5 kW

# MIG/MAG INVERTER DOUBLE PULSE



200 > 400 V-3 Ø

## NEOPULSE 300

15 **270 A**

FV TRI no accessories/no trolley : 032767

MERCEDES APPROVED

## NEOPULSE 300-T2

15 **270 A**

FV TRI no accessories : 032729

TESLA APPROVED

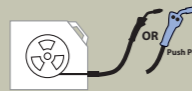

X2  
(200/300 mm)

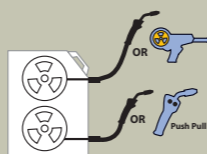

### ERGONOMIC & EASY

Large 5 inch LCD colour screen



4 DRIVE ROLLERS  
Ø 37 mm, MOTOR 75W  
Rollers Type C



DSP FULLY DIGITAL  
RJ12 - Software update

SYNERGIES UPDATE  
- Mise à jour des synergies



### NEOPULSE COMPLETE PACKS

TYPE C	Alu	Fe/CrNi	Alu	Push-Pull Alu
<b>NEOPULSE 300</b>				
pack NEOPULSE 300 A1 032682	Ø 0.8/1 (x2) (Original Equipment)	4 m, 35 mm <sup>2</sup> 043817	845 x 982 x 605 mm 033931	Cable support 032842
pack NEOPULSE 300 A2 032705	Ø 0.8/1 (x2) (Original Equipment)	Alu, Ø 1/1.2 (x2) 042162	4 m, 35 mm <sup>2</sup> 043817	845 x 982 x 605 mm 033931
MERCEDES APPROVED pack NEOPULSE 300 A3 022744	Ø 0.8/1 (x2) (Original Equipment)	Alu, Ø 1/1.2 (x2) 042162	4 m, 50 mm <sup>2</sup> 047853	845 x 982 x 605 mm 033931
MERCEDES APPROVED pack NEOPULSE 300 A4 022843	Ø 0.8/1 (x2) (Original Equipment)	Alu, Ø 1/1.2 (x2) 042162	4 m, 50 mm <sup>2</sup> 047853	845 x 982 x 605 mm 033931
pack NEOPULSE 300 A PUSH PULL 022706	Ø 0.8/1 (x2) (Original Equipment)	Alu, Ø 1/1.2 (x2) 042162	4 m, 35 mm <sup>2</sup> 043817	845 x 982 x 605 mm 033931
pack NEOPULSE 300 W1 032699	(Original Equipment)	4 m, 35 mm <sup>2</sup> 043817	WCT 1.3kW A 020344	Cable support 032842
pack NEOPULSE 300 W2 032712	Ø 0.8/1 (x2) (Original Equipment)	Alu, Ø 1/1.2 (x2) 042162	4 m, 35 mm <sup>2</sup> 043817	WCT 1.3kW A 020344
<b>NEOPULSE 300-T2</b>				
pack NEOPULSE 300-T2 022607	Ø 0.8/1 (x2) (Original Equipment)	Alu, Ø 1/1.2 (x2) 042162	4 m, 35 mm <sup>2</sup> 043817	Cable support 022553

### OPTIONS

Potence - Cable support	for Neopulse 300 032842	for Neopulse 300-T2 022553	845 x 982 x 605 mm 033931	Max 10 m <sup>3</sup> (50L)	cooling unit (5l)	WCT 1.3kW A 400 V, 2~ 1300W, 020344	CORAGARD CS 330 (10L) 052246
-------------------------	----------------------------	-------------------------------	------------------------------	--------------------------------	-------------------	--	------------------------------------

### SYNERGIES NEOPULSE 300

	Standard				Pulse		
	Ø0.6	Ø0.8	Ø1	Ø1.2	Ø0.8	Ø1	Ø1.2
Fe Ar CO <sub>2</sub> 18%	✓	✓	✓	—	✓	✓	—
Al Mg 5 Ar 100%	—	—	✓	✓	✓	✓	✓
Al Si 12 Ar 100%	—	✓ (Push Pull P)	✓	✓	✓ (Push Pull P)	✓	✓
Al Si 5 Ar 100%	—	✓ (Push Pull P)	✓	✓	✓ (Push Pull P)	✓	✓
Cr Ni 308 Ar 98% CO <sub>2</sub> 2%	—	✓	✓	—	✓	✓	—
Cr Ni 316 Ar 98% CO <sub>2</sub> 2%	—	✓	✓	—	✓	✓	—
Cu Si 3 Ar 100%	—	✓	✓	—	✓	✓	—
Cu Al 8 Ar 100%	—	✓	✓	—	✓	✓	—
Fe CO <sub>2</sub> 100%	—	✓	✓	—	—	—	—

### PUSH PULL TORCH - 24 V

OPTION NEOPULSE 270-T2, 300, 300-T2, 320-T3



### Ideal Alu MB15

Ø 0,8  
160 A (40%)  
Original equipment : Ø 0,6/0,8-1,0  
2,9 kg  
4m 044111

### Ideal Alu MB25

Ø 1,2  
220 A (20%)  
Original equipment : Ø 0,8-1,0/1,2  
4m 046283  
6m 048713  
option Ø 0,6 / 0,8-1,0  
046290

### SPOOLGUN

OPTION M1/T1/M3/T3 GYS AUTO, NEOPULSE 270-T2, 300-T2, 320-T3



Torche motorisée Spool Gun - Spool Gun Torch  
- Spool Gun Brenner  
041486

### Ideal Alu

Ø 0,8

& Acier/Steel/Stahl  
Inox/Stainless steel

4m



MADE IN FRANCE EN60974-1	50/60Hz	A	Ø mm	min → max	FV TRI	SPOOLGUN	PUSHPULL	200	300	Cooling system	ELECTRONIC CONTROL	EN60974-1 (40°C)		cm / kg	Protected & compatible power generator (+/-15%)	
												IA (60%)	X% (I2 max)			
NEOPULSE 300	230V - 3~ 400V - 3~	20 16	0.6 → 1.2	15 → 240 15 → 270	■	—	OPTION	■	■	Air	4	0.8 / 1.0 mm	220 240	240 A @ 60% 270 A @ 40%	38x52x64 / 41	10 kVA 12.5 kVA
NEOPULSE 300-T2	230V - 3~ 400V - 3~	20 16	0.6 → 1.2	15 → 240 15 → 270	■	OPTION	OPTION	■	■	Air	4	0.8 / 1.0 mm + 1/1.2 mm (Alu)	220 240	240 A @ 60% 270 A @ 40%	84x103x63 / 72	10 kVA 12.5 kVA

# MIG/MAG INVERTER DOUBLE PULSE



Latest generation colour screen 5" / 800 x 480 (WVGA)



## 3 WELDING MODES

### EASY



### EXPERT

Pre-gas / Hot Start / Upslope / Downslope / Crater filler / Post-gas



### ADVANCED

Arc length adjustments



### Fully DIGITAL

4 MICROPROCESSORS



### DSP

> 46 SYNERGIES

STEEL

Cu Si 3 / Cu Al 8

ALU

Up to 500 JOBS can be saved



EASY USB UPDATE

## PUSH PULL TORCH - 24 V

details p. 55 Motor inside



## SPOOLGUN TORCH

details p. 55



Autopulse 320-T3 036710	PACK 1	PACK 2
	059184	059191
	Steel 250 A, 3 m, air (x 2) 040700	Steel 250 A, 3 m, air (x 2) 040700
	Alu 250 A, 3 m, air 040724	—
	—	Push-Pull MB25 4m 046283
	4 m, 35 mm <sup>2</sup> 043817	4 m, 35 mm <sup>2</sup> 043817
	Coffret MB15 / MB25 250A 037458	Coffret MB15 / MB25 250A 037458

## AUTOPULSE 320 T3

15 320 A

no accessories :  
036710

### PROCESSES :

standard  
pulse  
pulse in pulse  
manual

NEW  
03/2018



## 46 SYNERGIES AUTOPULSE 320 T3

	Standard			Pulse		
	Ø0.8	Ø1	Ø1.2	Ø0.8	Ø1	Ø1.2
Fe Ar 18 CO <sub>2</sub>	✓	✓	—	✓	✓	—
Al Mg 3 Ar	✓	✓	✓	✓	✓	✓
Al Mg 5 Ar	✓	✓	✓	✓	✓	✓
Al Si 5 Ar	✓ (Push Pull P)	✓	✓	✓ (Push Pull P)	✓	✓
Al Si 12 Ar	✓ (Push Pull P)	✓	✓	✓ (Push Pull P)	✓	✓
Cr Ni 308 Ar 2 CO <sub>2</sub>	✓	✓	—	✓	✓	—
Cr Ni 316 Ar 2 CO <sub>2</sub>	✓	✓	—	✓	✓	—
Cu Si 3 Ar	✓	✓	—	✓	✓	—
Cu Al 8 Ar	✓	✓	—	✓	✓	—
Fe CO <sub>2</sub>	—	—	—	✓	✓	—

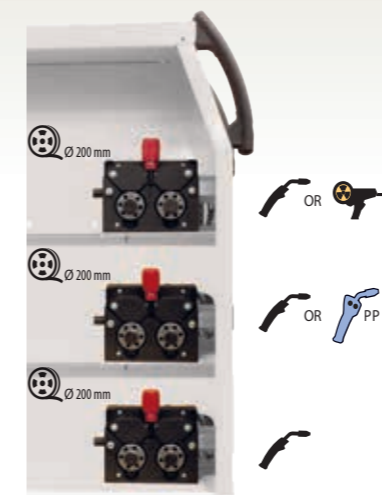

MADE IN FRANCE EN60974-1	50 / 60 Hz	A	Ø mm	min → max	SPOOLGUN	PUSH/PULL	200	Cooling system	Equipement d'origine Original equipment Originalausstattung Equipamiento de fabrica		EN60974-1 (40°C)	cm / kg	Protected & compatible power generator (+/-15%)
									ELECTRONIC CONTROL	IA (60%)			
<b>AUTOPULSE 320-T3</b>	400V-3~	16	0.6+1.2	15+320	OPTION	OPTION	■	Air	ACIER : 0.8 / 1.0 mm ALU : 1.0 / 1.2	260	320 A @ 60%	90x92,5x63 / 82.5	24 kVA

**MANUAL TORCHES** - Torches - Brenner - Antorcha - Lastoort - Tocha

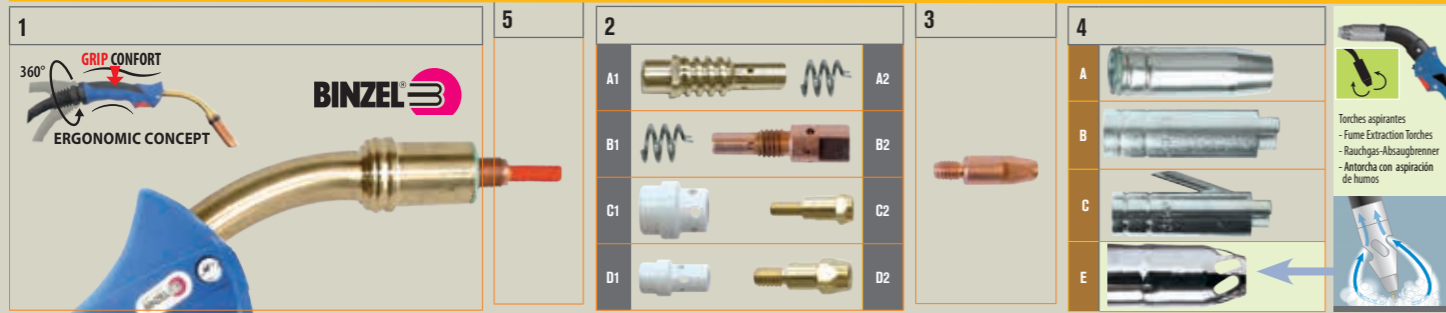

ACIER / INOX - Steel/Stainless steel - Stahl/Edelstahl				ALU - Aluminium - Aluminio			
AIR		LIQUID		AIR		LIQUID	

1 TORCHES COMPLÈTES - Complete Torches - Brenner - Antorcha - Lastoort - Tocha													
2	150 A				250 A				350 A				300 A
	A1 + A2	B1 + B2	D1 + D2	C1 + C2	A1 + A2	B1 + B2	D1 + D2	C1 + C2	A1 + A2	B1 + B2	D1 + D2	C1 + C2	A1 + A2
3	M6	M6	M8	M6	M6	M6	M8	M6	M6	M6	M8	M6	M6
original equip.	Ø 0.8 A	Ø 1.0 A	Ø 1.2 A	Ø 1.2 A	Ø 0.8	Ø 1.0	Ø 1.2	Ø 1.2	Ø 1.0 A	Ø 1.2 A	Ø 0.8 A	Ø 0.8 A	Ø 0.8 A
X% 40°C-ArCo <sub>2</sub>	150A - 60%	200A - 60%	290A - 60%	270A - 100%	150A-60%	200A - 60%	290A - 60%	270A - 100%	160A - 40%	220A - 20%	150A - 60%		
Classic	3m	—	—	—	041462	—	—	—	—	—	—	—	—
GRIP	3m	043268	040700	040687	040694	—	040724	040731	040748	—	—	—	—
	4m	—	040922	040946	043275	—	040939	040953	043282	044111	046283	041486	—
GRIP	3m	043251	040540	—	—	—	—	—	—	—	—	—	—
	4m	—	—	040557	—	—	—	—	—	—	—	—	—

2 SUPPORTS TUBE CONTACT & DIFFUSEURS - Tip adaptors & diffusers													
2	150 A				250 A				350 A				300 A
	A1 (x5)	B1 (x5)	D1 (x3)	C1 (x3)	A1 (x5)	B1 (x5)	D1 (x3)	C1 (x3)	A1	B1	A1	A1	
	042902	042995	043008	043589	042902	042995	043008	043589	042902	042995	042902	042902	
	A2 (x10)	B2 (x5)	D2 (x5)	C2 (x5)	A2 (x10)	B2 (x5)	D2 (x5)	C2 (x5)	A2	B2	A2	A2	
	042988	042919	042926	043541	042988	042919	042926	043541	042988	042919	042988	042988	

3 TUBES CONTACTS - Contact tips - Kontaktrohre - Tubo de contacto - Contactbuis - Pontas de contacto													
x10	150 A				250 A				350 A				300 A
	A1 (x5)	B1 (x5)	D1 (x3)	C1 (x3)	A1 (x5)	B1 (x5)	D1 (x3)	C1 (x3)	A1	B1	A1	A1	
Ø 0.6	041905	041905	—	041905	—	—	—	—	—	—	—	—	
Ø 0.8	041912	041950	041790	041950	041059	041059	—	041059	041059	041059	041059	041059	
Ø 1.0	041929	041967	419803	041967	041066	041066	419766	041066	041066	041066	041066	041066	
Ø 1.2	040144	041974	419810	041974	041073	041073	419773	041073	041073	041073	041073	041073	
Ø 1.4	—	—	419827	—	—	—	—	—	—	—	—	—	
Ø 1.6	—	—	419834	—	—	—	041080	—	—	—	—	—	
Ø 2.4	—	—	040533	—	—	—	—	—	—	—	—	—	

4 BUSES - Gas nozzles - Düsen - Tubo - Nippel - Bicos													
Conique - Conical nozzle - Konische Düse	150 A Ø12				250 A Ø15				350 A Ø16				300 A Ø17
	A (x3)	A (x3)	A (x3)	A (x3)	A (x3) Ø12	A (x3)	A (x3)	A (x3) Ø12	A (x3)	A (x3)	A (x3)	A (x3)	
	041875	041882	041783	043534	041875	041882	041783	043534	041875	041882	041875	041875	
E (x1)	E (x1)	E (x1)	—	A (x3) Ø16	—	—	A (x3) Ø12	—	—	—	—	—	
	043084	040571	040588	—	046214	—	—	046221	—	—	—	—	
Pointage - Spot welding - Punktdüse	B (x1)	041851	—	—	—	—	—	—	—	—	—	—	
Soude clou - Nail welding - Nagelschweißdüse	C (x1)	041523	—	—	—	—	—	—	—	—	—	—	
Special No Gas (isolated)	D (x1)	041868	—	—	—	—	—	—	—	—	—	—	

5 GAINES - Torch liners - Mantel - Funda - Drahtseelen - Folha												
Acier - Steel - Stahl - Acero - Staal - Aço	Teflon											
	3 m	4 m	4 m	4 m	4 m	4 m	4 m	4 m	4 m	4 m	4 m	4 m
Ø 0.6/0.8	041592	041837	041578	044050	041585	044067	039834	039827	039810	—	—	—
Ø 1.0	041608	041844	041578	044050	041585	044067	039834	039827	039810	—	—	—
1.2	041844	—	041578	044050	041585	044067	039834	039827	039810	—	—	—

COFFRETS - Boxes - Verschleißteilebox - Cajas - Kistjes - Estojos												
MB 15 (150 A)	MB 15 / MB 25 (250 A)	MB 25 (250 A)	MB 36 (350 A)									
041226	037458	041233	041417									
x5 (M6-Ø 0.8) x5 (M6-Ø 1.0) x5 (Alu - M6-Ø 0.8)	x5 (M6-Ø 0.8) x5 (M6-Ø 1.0) x5 (Alu - M6-Ø 0.8)	x5 (M6-Ø 0.8) x5 (M6-Ø 1.0) x5 (Alu - M6-Ø 0.8)	x5 (M6-Ø 0.8) x5 (M6-Ø 1.0) x5 (Alu - M6-Ø 0.8)									

**BOBINES DE FIL**  
- Welding wire reels - Drahtrollen - Rollos de hilo- Draadbobijn  
- Bobines de fio

	kg	Ø	Ø 0.6 mm	Ø 0.8 mm	Ø 1.0 mm	Ø 1.2 mm	EXCELLIUM			NORMES - Norms - Normen - Norma			
							Ø 0.8 mm	Ø 1.0 mm	Ø 1.2 mm	AWS	EN	DIN	
Acier - Steel - Stahl - Acero - Staal - Aço (SG2)	0.9	100 mm	—	086593	086609	—	—	—	—	—	—	—	—
	5	200 mm	—	086111	086128	086135	—	—	—	AWS 5.18 : ER 70S-6	EN ISO 14341-A : G46 4M G3Si1	DIN 8559 : SG2	—
	15	300 mm	—	086166	086227	086234	086241	086302	086319	—	—	—	—
	15	300 mm	—	—	086258	—	—	—	—	AWS 5.28 : ER 90S-B3	EN ISO 21951-A : Cr CrMo2Si	—	—
Acier - Steel - Stahl - Acero - Staal - Aço (UHSS)	5	200 mm	—	—	086203	—	—	—	—	AWS/ASME SFA-5.28 : ER 120 S-G	EN ISO 12534 : Mn4Ni2, 5CrMo	—	—
	5	200 mm	—	086760	086777	—	—	—	—	AWS 5.18 : ER 70S-2	EN ISO 14341-A : G42.2 M G2Ti	DIN 8559 : SG2	—
Galva (G2Ti)	2	200 mm	—	—	—	—	086517	—	—	—	—	—	—
	7	300 mm	—	—	—	—	086500	—	—	—	—	—	—
Alu (AlMg3)	0.5	100 mm	—	—	086548	—	—	—	—	—	—	—	—
	2	200 mm	—	—	086555	086562	—	—	—	—	—	—	—
Alu (AlMg5)	2	200 mm	—	—	—	—	—	—	—	—	—	—	—
	7	300 mm	—	—	—	—	—	—	—	—	—	—	—
Alu (AlSi5)	0.5	100 mm	—	—	086685	—	—	—	—	—	—	—	—
	2	200 mm	—	—	086142	086159	—	—	—	—	—	—	—
Alu (AlSi12)	0.5	100 mm	—	—	086678	—	—	—	—	—	—	—	—
	2	200 mm	—	—	086067	086074	—	—	—	—	—	—	—
Cusi3 HLE - UHTS (Boron Steel)	1	100 mm	—	—	086692	—	—	—	—	—	—	—	—
	5	200 mm	—	—	086647	086654	—	—	—	086210	—	—	—
CuAl8 HLE - UHTS (Boron Steel)	5	200 mm	—	—	086661	086197	—	—	—	086210	—	—	—
	15	300 mm	—	—	—	086180	—	—	—	—	—	—	—

**GALETS - Rollers - Vorschubrollen - Rollen - Rodillos - Wielen - Roletes**

	TYPE A	TYPE B		TYPE C					
		Ø 30mm	Ø 9mm	Ø 37mm	Ø 9mm				
Acier - Steel - Stahl - Acero - Staal - Aço Inox - Stainless	Ø 0.6 / 0.8	(x1)	042339	(x1)	042087	(x2)	042353	(x2)	041738
	Ø 0.8 / 1.0	(x1)	041189	(x1)	042100	(x2)	042360	(x2)	042094
	Ø 1.0 / 1.2	—	—	(x1)	042179	(x2)	046849	(x2)	042117
	Ø 1.2 / 1.4	—	—	—	—	(x2)	—	(x2)	039780
Alu	Ø 0.8 / 1.0	(x1)	041196	(x1)	042155	(x2)	042377	(x2)	042148
	Ø 1.0 / 1.2	—	—	(x1)	042186	(x2)	040915	(x2)	042162
	Ø 1.2 / 1.6	—	—	—	—	(x2)	042391	(x2)	041776

**PINCE SPÉCIALE MIG/MAG-ORIGINAL FIX - Special MIG-MAG plier - Spezial MIG/MAG Zange - Pinza especial MIG/MAG**

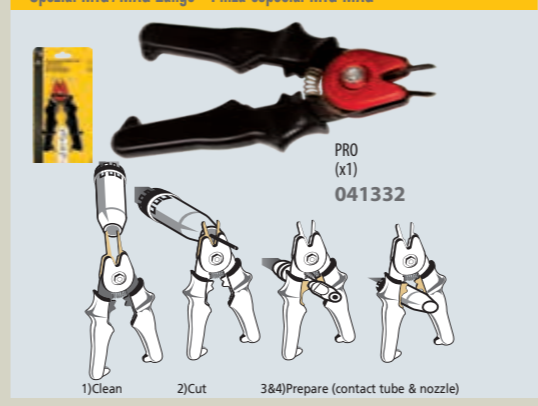

1) Clean 2) Cut 3&4) Prepare (contact tube & nozzle)  
PRO (x1) 041332

**ADAPTATEURS BOBINES - Adaptors for wire reels - Korbspulenadapter**



ALIGNER 200 Ø 200 042889  
After sales Professional 71608 Ø 200 & 300 Industrial 71613 Ø 200 & 300

**SUPPORT TORCHE MAGNÉTIQUE - MIG torch stand with magnetic base**



041653

# HELMETS

TEINTE SHADE 9/13

EN 175-EN 379



**TECHNO 9/13**  
042544



**MASTER 9/13 G**  
**IRON** 038325 **BONES** 038318 **LCD** 040861



**EXPERT 9/13 G**  
042216



**EXPERT 9/13 G CARBON**  
040878



**HERMÈS**  
**SILVER** 040908 **RED** 040885 **GOLD** 040892

**NEW DESIGN**



**NEW**

**NEW**



**PROMAX 9/13 G**  
**VOLCANO** 037205 **SHARK** 037199 **SILVER** 045774



LARGE PROTECTION



**ZEUS 5-9/9-13 G**  
**INDIAN** 038332 **FIRE** 044098 **COSMIC** 044104



**NEW**



**ERGOTECH 5-9/9-13**  
**SILVER** 044173 **BLACK** 045477 **DREAM** 037212

Option

Sac pour masque de soudage - Carry bag for helmet welding

043299



LARGE PROTECTION



**SPACEVIEW 5-9/9-13**  
040717

LCD AUTOMATIC TECHNOLOGY	BASIC			PRO			PRO+		EXPERT		
	TECHNO	MASTER	EXPERT	HERMES	PROMAX	ZEUS	ERGOTECH	SPACEVIEW	GYSMATIC		
MODEL											
REF	042544	(iron) 038325 (bones) 038318 (lcd) 040861	(carbon) 040878 (blue) 042216	(silver) 040908 (red) 040885 (gold) 040892	(volcano) 037205 (shark) 037199 (silver) 045774	(indian) 038332 (fire) 044098 (cosmic) 044104	(silver) 044173 (black) 045477 (dream) 037212	040717	043909	046818	
□→■	0.30 ms	0.30 ms	0.30 ms	0.30 ms	0.25 ms	0.20 ms	0.20 ms	0.10 ms	0.08 ms	0.10 ms	
⚡	4 - 9>13	4 - 9>13	4 - 9>13	4 - 9>13	4 - 9>13	5>9 9>13	5>9 9>13	5>9>13	4 - 9>13	4 - 5>13	
🔍	1/2/1/1	1/2/1/2	1/1/1/2	1/1/1/3	1/1/1/2	1/1/1/2	1/1/1/2	1/1/1/2	1/1/1/2	1/2/1/1	
👁	92x42 mm	92x42 mm	98x43 mm	98x43 mm	100x49 mm	XL : 100x67 mm	XL : 100x67 mm	XXL : 100x93 mm	100x60 mm	XXL : 100x83 mm	
🔊	2	2	2	2	2	4	4 HIGH SENSITIVITY	4 HIGH SENSITIVITY	4 HIGH SENSITIVITY		
MEMORY & REGULATIONS										<b>ELECTRONIC</b>	
🔌		✓	✓	✓	✓	✓	✓	✓	✓	✓	
📺 HF										✓	
🔍						✓	✓	✓			
⚡	☀	☀	☀ + 2 ⚡ (CR 2032)	☀ + 2 ⚡ (CR 2032)	☀	☀ + 2 ⚡ (CR 2450)	☀ + 2 ⚡ (CR 2450)	☀ + 2 ⚡ (CR 2032)	☀ + 2 ⚡ (CR 2450)	☀ + 1 ⚡ (CR 2450)	
🔄	Simple	Simple	Simple	Simple	Simple	Multi	Multi	Multi	Simple		
👤	440 g	470 g	510 g	485 g	465 g	515 g	560 g	530 g	575 g	575 g	
BRAND MASK	<i>Tool-it</i>	<i>Top Arc</i>	<i>Tool-it</i>	<i>Tool-it</i>	<i>Tool-it</i>	<i>Tool-it</i>	<i>Top Arc</i>	<i>Tool-it</i>	<i>Gys</i>		

VERRES - Lense - Schutzgläser

👁	110 x 90	x5	040816	116 x 89.5	x5	040779	111.2x91 115x 102	x5 + x5	040793	111.2x91 115x 102	x5 + x5	040793	226 x 106	x5	045781	114 x 133	x10	043893	114 x 133	x10	043893	114 x 133	x10	043893
	95.5 x 50.5	x5	040854	103.5 x 53	x5	040786	103.6 x 54	x5	040809	103.6 x 54	x5	040809	104 x 55	x5	040847	103.7 x 69.5	x5	043695	103.7 x 69.5	x5	043695	104 x 96	x5	043596
																			G : 106 x 66	x10	043886	XL : 106 x 89.5	x10	046825

**TOP QUALITY**

**EXPERTS : GYSMATIC**

IDEAL

MEMORY & REGULATIONS ELECTRONIC

**GYSMATIC 5/13 XXL**  
046818

**GYSMATIC 9/13 G**  
043909



# HELMETS

TEINTE  
SHADE **5/9-9/13**

EN 175-EN 379  TRUECOLORS



## TRUECOLORS

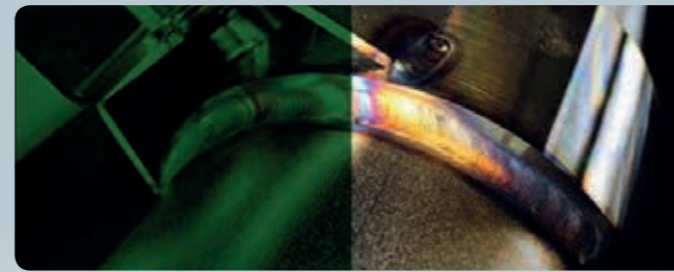
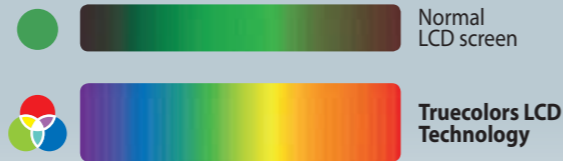

Normal LCD screen Truecolors LCD Technology

x3 LCD screens

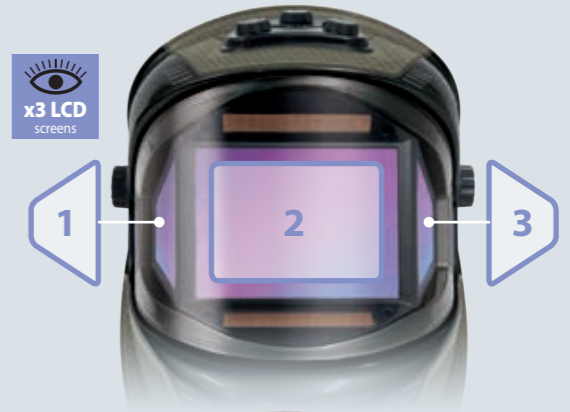

65

HELMETS

NEW



**ALIEN TRUECOLOR XXL**  
037229

LARGE PROTECTION

NEW



**GYSMATIC TRUECOLOR XXL**  
037236

MEMORY & REGULATIONS ELECTRONIC



NEW



**OPTREL PANORAMAXX**  
037298

USB charge

optrel  
swiss made



6x  
Field of view

auto shade  
5  
12 10

Shade level  
2.5



**PANORAMIC 3XL**  
037281

x3 LCD screens

NEW

LARGE PROTECTION

LCD AUTOMATIC TECHNOLOGY	XXL		OPTREL	PANORAMIC	EXPERT + AIR	
MODEL	ALIEN	GYSMATIC	PANORAMAXX	PANORAMIC	NAVITEK	GYSMATIC AIR
REF	037229	037263	037298	037281	045835	047846
□→■	0.15 ms	0.10 ms	0.05 ms	0.15 ms	0.10 ms	0.10 ms
▨	4-5>9-9>13	4-5>13	2.5-5>12	4>8-8>13	5>8-9>13	4-5>13
↻	1/1/1/2	1/1/1/1	1/1/1/2	1/1/1/1	1/1/1/2	1/2/1/1
↔	XXL : 100x90 mm	XXL : 100x83 mm	125x58 mm	131x84 + 2x(67x75) mm	100x50 mm	XXL : 100x83 mm
)))	4 HIGH SENSITIVITY	4 HIGH SENSITIVITY	5 HIGH SENSITIVITY	4 HIGH SENSITIVITY	4 HIGH SENSITIVITY	4 HIGH SENSITIVITY
MEMORY & REGULATIONS					ELECTRONIC	ELECTRONIC
🔊	✓	✓	✓	✓	✓	✓
☑️ HF	✓	✓	✓	✓	nc	✓
🔍					✓	
🔋	☀️ + 2 🔋 (CR 2032)	☀️ + 1 🔋 (CR 2450)	Rech. Lithium Battery	☀️ + 2 🔋 (CR 2450)	☀️ + 2 🔋 (CR 2330)	☀️ + 1 🔋 (CR 2450)
🔄	Multi	Simple	Simple	Multi	Simple	Simple
👤	545 g	575 g	550 g	610 g	1.6 kg	2.4 kg
BRAND MASK	Tool-it	Gys	Optrel	Tool-it	Weltek	Gys

VERRES - Lense - Schutzgläser

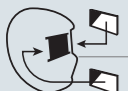
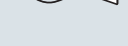
	114 x 133	x10	043893	114 x 133	x10	043893	270 x 115	x5	037335	385 x 150	x5	037311	110 x 97	x10	045798	114 x 133	x10	043893
	104 x 96	x5	043596	106 x 89,5	x10	046825	145 x 65	x5	037342	Special kit (x3)	x5	037304	103 x 53	x10	045811	106 x 89,5	x10	046825



**NAVITEK 5/8 - 9/13 +G VISOR**  
045835

Filtration class EN 12941 : TH2 P R SL

Air 180 & 220 L/min  
8>10h BATTERY LIFE (included)

Visor (x5) 045828

Filter x10 045859

045866



**GYSMATIC 5/13 AIR XXL**  
047846

Filtration class EN 12941 : TH2 P R SL

Air 165 / 200 / 220 L/min  
Battery included

Battery charger 037472

Battery included 037465

x1 038424

x5 038417

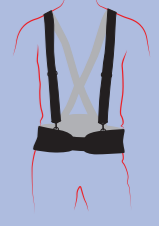

# INDUCTION HEATING

1 ⌀

## HAND-DUCTION HEATING SYSTEM



MADE IN HIGH QUALITY USA

Ergonomique et léger  
- Lightweight and ergonomic design  
- Leicht und einfach zu Bedienen

Refroidi air  
- Air cooled - Luftgekühlt

Verrouillage facile des inducteurs  
- Coil Twist Lock  
- Einfaches Verriegeln der Induktoren

Éclairage LED  
- Light LED  
- LED zum Erhitzen des Blechs

**1 000 W**

with accessories • EUR • 230 V :  
056923

UK : 057371 (230V)  
US : 057395 (110V)  
AU : 057388 (230V)

L : 37cm • Ø : 8.2 cm • 2.54kg • 5A  
40-80 KHz



### INCLUDED

Spirale - Coil - Spiralförmiger draht	Fil tressé enroulable - Flexible wrappable wire - Flexibel geflochtener draht	Fil droit rigide - Straight rigid wire - Steif gerade draht
Ø 22mm (7/8 in.)	1 m (41 in.)	584 mm (23 in.)

## GYSDUCTION AUTO

**2 400 W**

PFC



PFC POWER FACTOR CORRECTION

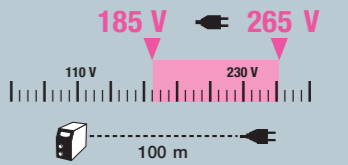

### COMPLETE

	Décapage - Glass - Entfernen 053373
	Décollage - Decal - Entkleben 053359
	Dérippage - Bolt heating - Lösen 053366

### Protections Options

Protection (x5) + Colle - Stick 053854	Protection (x5) + Colle - Stick 059108	Protection (x10) + Colle - Stick 053847

NEW

### OPTION

Spray refroidisseur - Freezer spray

-50 °C  
400 ml

(x 12)  
048898



Adhesive for logo (x10)  
051492



Débosselage rapide et sans peinture  
- Fast and paintless dent pulling  
- Lackschadenfreies Ausbeulen  
054776  
Licensed by BETAG innovation



### Spirale - Coil - Spiralförmiger draht

	Ø 18 mm 054806
	Ø 24 mm 054790
	Ø 30 mm 055469
Fil tressé enroulable - Flexible wrappable wire - Flexibel geflochtener draht	
	800 mm 054813
Fil droit rigide - Straight rigid wire - Steif gerade draht	
	800 mm 054868

## PACKS GYSDUCTION AUTO

1 box

### GYSDUCTION AUTO

	GYSDUCTION AUTO	Plastic wedges 051294	Burn off Inductor Décapage - Burn off - Entfernen 053373	Body Inductor Décollage - Removal - Abkleben 053359	Bolt Inductor Dérippage - Heating - Lösen 053366	Remote control Télécommande - Fußschalter 055490	Trolley Universal 800 051331	Cable support 052284	Dent pulling Inductor Débosselage - Dent pulling - Ausbeulinductor 054776	Spiral inductor - Inducteur spirale - Spiralinductor 054783
<b>PROLINER AUTO</b> 048775	☐	☐	☐	☐	☐	☐	☐	☐	☐	☐
<b>COMPLETE AUTO</b> 053380	☐	☐	☐	☐	☐	☐	☐	☐	☐	☐
<b>COMPLETE AUTO +</b> 056978	☐	☐	☐	☐	☐	☐	☐	☐	☐	☐
<b>MECA AUTO</b> 048812	☐	☐	☐	☐	☐	☐	☐	☐	☐	☐
<b>MECA AUTO +</b> 056961	☐	☐	☐	☐	☐	☐	☐	☐	☐	☐
<b>BODY SHOP AUTO</b> 048799	☐	☐	☐	☐	☐	☐	☐	☐	☐	☐
<b>GLASS AUTO</b> 048805	☐	☐	☐	☐	☐	☐	☐	☐	☐	☐
<b>DENT REPAIR AUTO</b> 054981	☐	☐	☐	☐	☐	☐	☐	☐	☐	☐

EN-60 335/1	MADE IN FRANCE	50/60 Hz	A	W	kHz	PFC	FV	Liquid Cooling	Cable L (m)	cm	kg
									Inductor		
<b>GYSDUCTION AUTO</b>											
		230V, 1~	16	2400	35+120	☐	☐	—	2	2.5	7.2

INDUCTION HEATING SYSTEM



**POWERDUCTION 37LG**  
**3 700 W**



no accessories:  
056992

**OPTIONS**



2 m

**POWERDUCTION 39LG**  
**3 700 W**



no accessories:  
058583

**PFC POWER FACTOR CORRECTION**

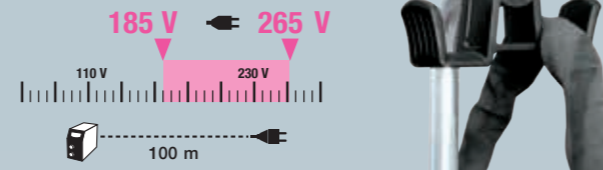

3 m

**POWERDUCTION 50LG**  
**5 200 W**



no accessories:  
055599

**PFC POWER FACTOR CORRECTION**

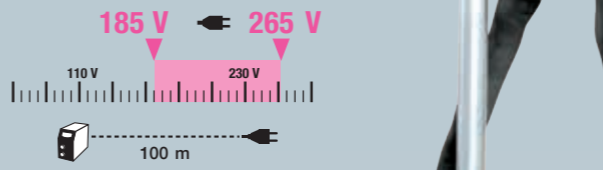

3 m



**POWERDUCTION 160LG**  
**16 000 W**



no accessories:  
057814

**NEW**  
04/2018



6 m

**OPTIONS**



CORAGARD CS 330 10l  
Liquide de refroidissement  
- Cooling liquid - Kühlmittel  
- Enfriamiento líquido -  
Refrigeração líquida  
052246

**39LG & 50LG**



**37LG**



							Cable L (m)				
	Hz	A	W	kHz	PFC	Liquid Cooling	Inductor	Inductor	cm	kg	
<b>POWERDUCTION 37LG</b>	230 V, 1~, 50/60 Hz	16 mini	3 700	15+30	—	1.5l	2	2	—	45 x 28.5 x 25	15
<b>POWERDUCTION 39LG</b>	230 V, 1~, 50/60 Hz	16 mini	3 700	30+50	■	7l	2	3	■	53 x 70 x 37	50
<b>POWERDUCTION 50LG</b>	230 V, 1~, 50/60 Hz	25 mini	5 200	30+50	■	7l	8	3	■	88 x 59 x 59	70
<b>POWERDUCTION 160LG</b>	400 V, 3~, 50/60 Hz	32 mini	16 000	25+40	—	30l	5	6	—	70 x 101.5 x 60	150

# PLASMA CUTTER

1 Ø



## EASYCUT 40

**40 A**

ALU 10mm  
INOX/STEEL 15mm

with accessories:  
029743



**NEW**  
05/2018

INCLUDED:  
8mm  
10mm



**PFC** POWER FACTOR CORRECTION

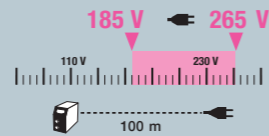

**AD** ANTI-DUST VENTILATION CORRIDOR



**FV** FLEXIBLE VOLTAGE

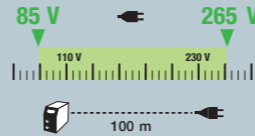

**Kompressor**  
INSIDE



## CUTTER 25 K

**25 A**

ALU 6mm  
INOX/STEEL 8mm

20 A on 13 A fuse

with accessories:  
030947

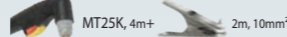

## CUTTER 35 KF

**35 A**

ALU 10mm  
INOX/STEEL 15mm

30 A on 13 A fuse

with accessories:  
031036

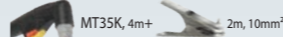

AIR FILTER



## CUTTER 31 FV

**30 A**

ALU 10mm  
INOX/STEEL 15mm

30 A on 13 A fuse

with accessories:  
030985

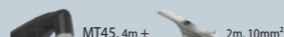

## CUTTER 40 FV

**40 A**

ALU 15mm  
INOX/STEEL 20mm

30 A on 13 A fuse

with accessories:  
031043

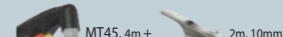

INCLUDED:  
8mm  
10mm



RENAULT  
www.renault-equipment.com



ACCESSOIRES / ACCESSORIES



CONSOUMMABLES / CONSUMABLES

	MT 25K	MT 35K	MT Easycut
	x4 040182	x4 040229	x4 040236
	x10 040151	x10 040212	x10 040212
	x2 040175	x1 040175	x1 040175
	x10 040168	x10 040168	x10 040168
Coffret - Box	039971	039964	039957

Chariot/Trolley/Fahrgewagen



Filtre déshumidificateur spécial Plasma  
- Compressed air cleaning filter for Plasma Cutter 31/40  
039728

Cartouche pour filtre  
- Filter cartridge 039735

**NEW**  
PERFORMANCES

MADE IN GYS CHINA	50/60 Hz	I <sub>2</sub>	mm				INTEGRATED TECHNOLOGY				AIR SYSTEM			EN 60974-1 (40°C)		cm	kg	Protected & compatible power generator (+/-15%)			
			Max Cut	Clean Cut	PFC	FV	AD	KOMPRESSOR INSIDE	mini	ideal	maxi	IA 60%	X% I2 max								
MADE IN FRANCE	<b>EASYCUT 40</b>	230V 1~	16	10+40	15	10	10	8	—	—	—	—	2.5 bar	4.5 bar 115l/m	6.5 bar	10 (50%)	20	15 x 42 x 30	8	—	—
	<b>CUTTER 25K</b>	230V 1~	16	5+25	8	6	6	4	—	—	—	—	included	—	—	12	26	22 x 45 x 31	17.2	4.1 kW	5.9 kVA
	<b>CUTTER 35KF</b>	230V 1~	16	10+35	15	10	8	6	—	—	—	—	included	—	—	28	30	28 x 52 x 46	30	8 kW	10 kVA
	<b>CUTTER 31FV</b>	230V 1~	16	5+30	10	8	10	8	—	—	—	—	2.5 bar	4.5 bar 115l/m	9 bar	22	32	19 x 44 x 28	12	6 kW	7.5 kVA
<b>CUTTER 40FV</b>	110V 1~	32	5+30	—	—	—	—	—	—	—	—	—	—	—	19	25	—	—	—	—	—
	230V 1~	16	10+40	20	15	15	10	—	—	—	—	—	2.5 bar	4.5 bar 115l/m	9 bar	32	40	21 x 51 x 37	20	8 kW	10 kVA
	110V 1~	32	10+30	—	—	—	—	—	—	—	—	—	—	—	25	40	—	—	—	—	—

**COFFRET DE DÉCOUPE PARE-BRISE**  
- Professional Box Set for Windscreen Removal - Frontscheiben-Trennsystem für Akkuschrauberbetrieb

057654

included  
65 m  
058125



MADE IN HIGH QUALITY GERMANY



**COUPEAU PNEUMATIQUE DE DÉCOUPE PARE-BRISE**  
- Oscillating Pneumatic Saw for Windscreen Removal - Druckluft-Trennmesser für Windschutzscheiben

057623

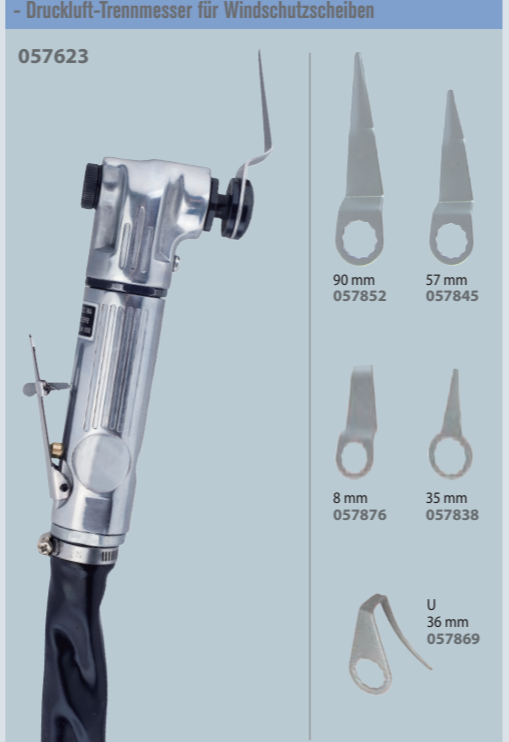

90 mm 057852    57 mm 057845

8 mm 057876    35 mm 057838

U 36 mm 057869

**COFFRET PRO DE RÉPARATION PARE-BRISE** - Professional Boxset for Windscreen Repair - Frontscheiben-Reparatursystem

057661

MADE IN HIGH QUALITY DENMARK

HBC system

- films UV - UV films - UV-Film (x10) 058163
- lames de rasoir - Razor blades - Ersatzklinge (x10) 058156
- seringues 1 ml + aiguilles - 1ml syringes and needles - Spritze 1ml und Kanüle (x3) 058170
- frises bleues - Blue drill - Glasbohrer blau (x2) 058132
- frises jaunes - Yellow drill - Glasbohrer gelb (x2) 058149
- polish de finition - Finishing polish - Finishingspolitur (15 ml) 058200
- résine injection - Injection resin - Injektionsharz (5 ml) 058187
- résine de finition - Finishing resin - Finishingsharz (5 ml) 058194



**SYSTÈME DE DÉCOUPE PARE-BRISE A CLIQUET**  
- Windshield Cutting kit - Kit zum Lösen von Windschutzscheiben

054738



Diagram showing the cutting process on a windshield.

**PROTECTIONS TABLEAU DE BORD**  
- Dashboard Protector - Armaturenbrett Schutz

053120



**EXTRACTEUR D'ESSUIE-GLACE** - Removal tool for windscreen wiper arms - Wischerarm-Abzieher

UNIVERSEL 057630

EXPERT 057647

Accès difficile - Difficult access

30 mm max

40 mm max



**VENTOUSES** - Suction Lifting Pads - Saugnapfwerkzeug für Spiegelgläser

056695

051966 x2

070 mm

x6 057609



**OUTIL DÉCOUPE PARE-BRISE**  
- Windshield Cutting Tool - Windschutzscheiben-Ausglas-Set

051935



**KIT DÉCOUPE JOINT DE PARE-BRISE** - Windscreen Joint-cutting Kit - Scheibentrenn-Werkzeug-Set

051898

051911

051881

Corde à piano torsadé (22 m) - Windscreen seal cutting wire (twisted) - Piano-Schneiddraht, gedreht, 22 m Rolle

Corde à piano carré (50m) - Windscreen seal cutting wire (square) - Vierkant-Draht, 50 m Rolle



**RENOV'POLYCARBONATE** - Compressed air polisher - Druckluftpolierer

2 SPEED

052086

Complete pack

1 ponceuse orbitale + 1 lustreuse + 1 orbital sander + 1 polisher

052055

052062

052079

058224

Ø 76

P 500 (x 10)

P 800 (x 10)

P 1500 (x 10)

P 3000 (x 10)

P 500 x 50 052017

P 800 x 50 052024

P 1500 x 50 052031

P 3000 x 50 052048



**AGRAFEUSE POUR RÉPARATION PARE-CHOCS** - Hot stapler for bumper repair - Stoßstangen Reparatur Kit

052925  
US : 056947 (110V)



INCLUDED :

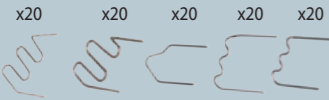

MADE IN TAIWAN



**PORTABLE**  
Sur batterie - Battery operated  
058118

included  
Li-ion battery 3.7V  
048669  
included adapters:  
EUR, UK, USA & AUS

INCLUDED :

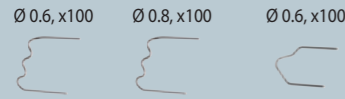

MADE IN TAIWAN



Adjustable

048669

048652

Agrafes - staples	V Angle interne étroit - Inside corner Ø 0.7 mm	U Alignement de fissure - Crack alignment Ø 0.7 mm	N Fissure importante - Large crack Ø 0.7 mm	W Angle interne - Internal angle Ø 0.7 mm	M Angle externe - External angle Ø 0.7 mm
x 100 047990	x 100 047983	x 100 047976	x 100 047969	x 100 047952	
052413					
x 50	+ x 50	+ x 50	+ x 50	+ x 50	+ x 50



**KIT DE SOUDAGE DES PLASTIQUES** - Welding Kit for Plastics - Kunststoff-Schweißset

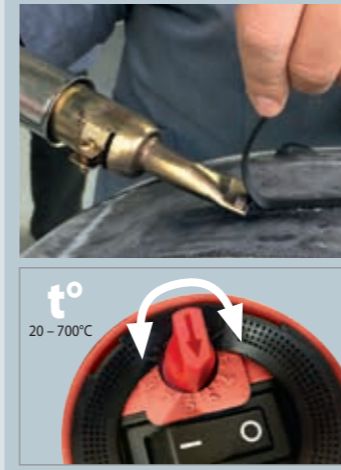

1 600 W - 230V - 50/60 Hz  
max. 230 l/min  
1.3 kg / -L Ø100 x 300mm,  
poignée Ø 56mm.



**ADHÉSIF BICOMPONENTS POUR RÉPARATION PARE-CHOCS** - Dual Component Bonding Gun for Plastic Repairs - 2-Komponenten-Klebekit für Stoßfänger

057685



120 s / 50 ml  
included x2  
30 s / 50 ml  
Séchage rapide  
- Fast dry  
- Schnelltrockner  
included x1

120 s / 50 ml  
057722  
x 6  
x 10  
30 s / 50 ml  
Séchage rapide  
- Quick dry  
057715  
x 6  
x 10  
x 10  
057708

**PRIMER FLEX**

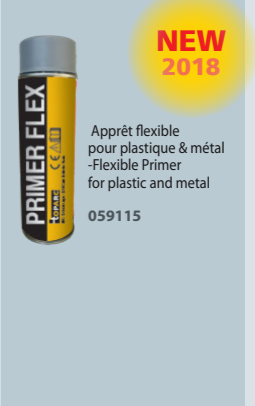

**NEW 2018**  
Apprêt flexible pour plastique & métal  
-Flexible Primer for plastic and metal  
059115

**COFFRET DE RÉPARATION DES PLASTIQUES AUTOMOBILES** - Brazing automotive plastics repair kit - Kunststoff Reparatur Kit

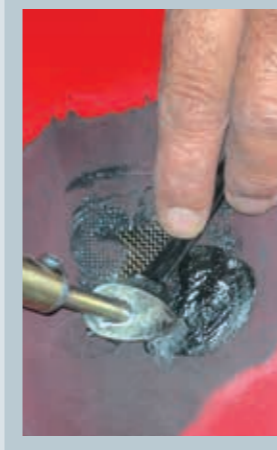

052932  
MADE IN BELGIUM

**FREEZER**

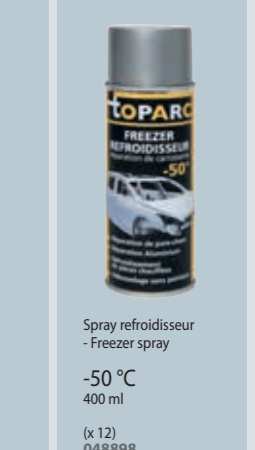

Spray refroidisseur  
- Freezer spray  
-50 °C  
400 ml  
(x 12)  
048898

**COFFRET DE PERÇAGE PARE-CHOCS POUR DÉTECTEURS** - Piercing Kit for Bumper Sensors - Lochwerkzeug für Stoßfänger



**BASIC**  
057739  
x 4  
Ø 18,2 mm  
Ø 26,0 mm

**PRO**  
057746  
x 12  
Ø 18,2 mm  
Ø 18,4 mm  
Ø 26,0 mm

**PRO+**  
059139  
x 12  
Ø 17-18-18,2  
19-20-22,5-24  
26-26,7-32 mm

BUMPER REPAIR • RÉPARATION PARE-CHOCS

MADE IN  
HIGH  
QUALITY  
GERMANY



**KIT MARTEAUX ET TAS** - Planishing Kit for Car Body (Set of 3 Hammers + 4 Dollies)  
- Karosseriehammer & Handfaust Kit



**OUTILS DE FORME** - Forming tools - Formgebungswerkzeuge



**BURINS** - Hand Chisel for Car Body  
- Meißel für Karosserie

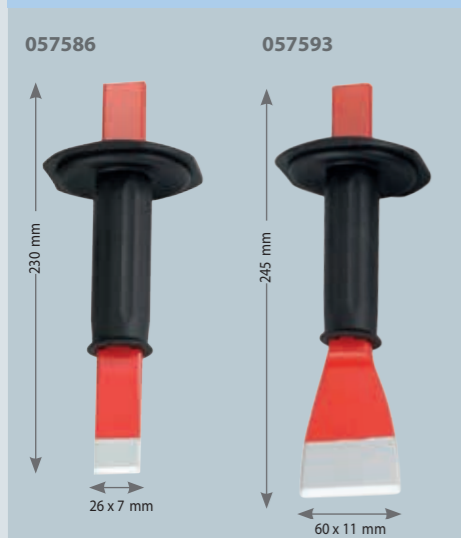

**JEU DE 4 BURINS EN NYLON**  
- Set of 4 nylon chisels - 4 Kunststoffmeißel

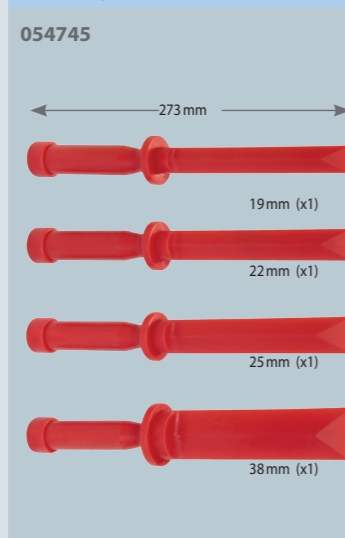

**OUTILS DE DÉGARNISSAGE ET RACLAGE** - Set of 30 Tools for scraping/sanding and paint removal - Polster & Schaber Kit



**JAUGES DE PROFIL** - Contour Gauge - Konturenlehre

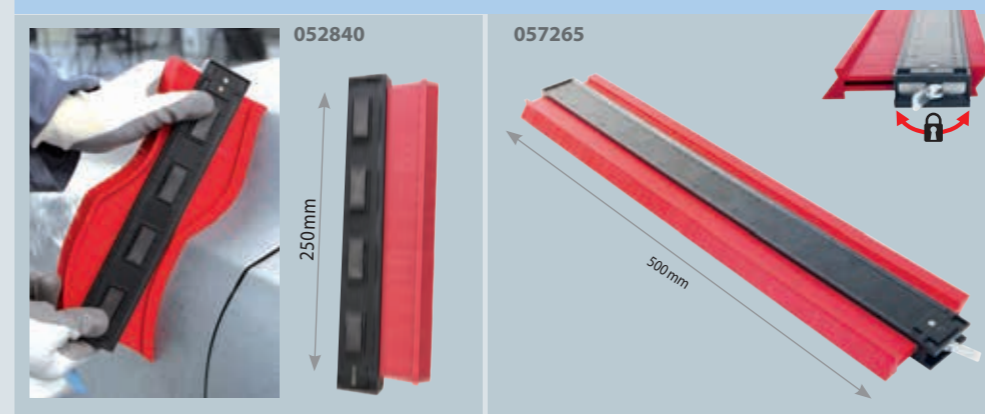

**JAUGES DE POSITIONNEMENT** - Gapping gauges - Spaltmaßlehre



**OUTIL DE REMISE EN FORME**  
**PASSAGE DE ROUE** - Fender roller tool set

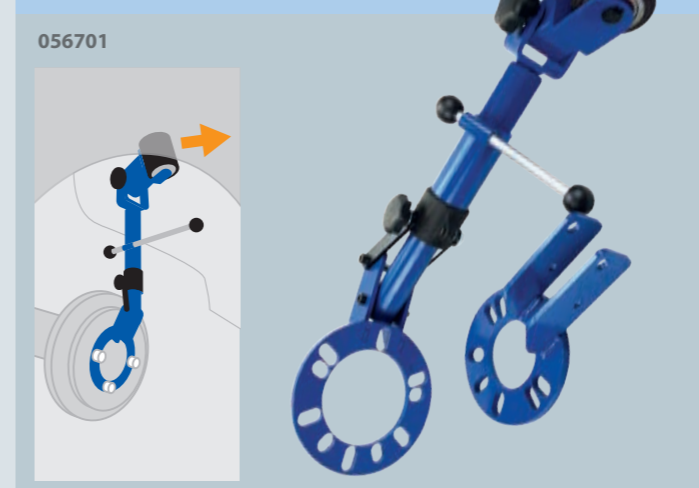

**PINCES DE MAINTIEN BORD À BORD** - Positioning clamp - I-Stoß-Lehre



**OUTIL DE POINÇONNAGE OBLONGS**  
- Oval hole punch - Länglochkarosserieblechzange

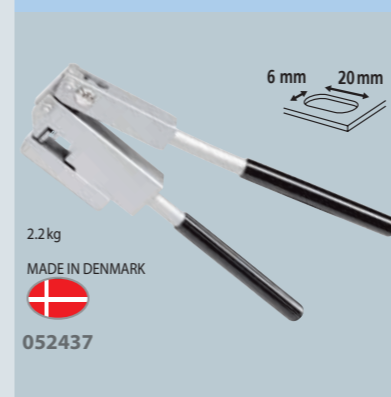

**REDRESSEUR DE CHARNIÈRE DE PORTE**  
- Fixed Hinge Bending Tool

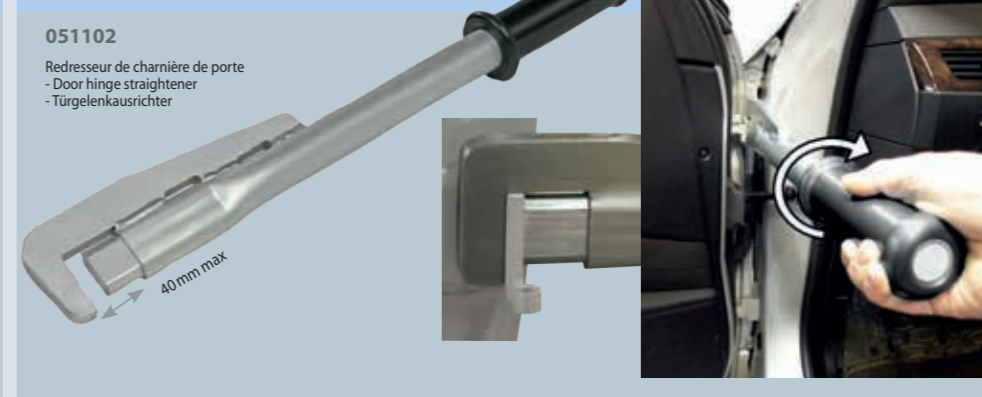

**PINCES AXIALES** - Axial-grip pliers

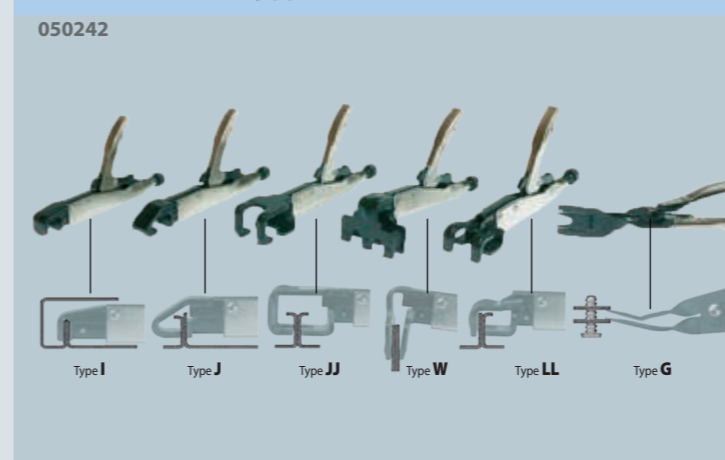

**PINCES ÉTAU MONO SERRAGE** - Lock-grip pliers

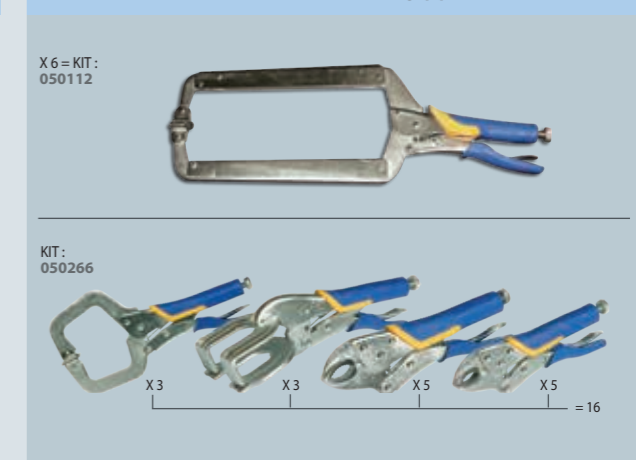

**MEULEUSE D'ANGLE** - Long Handled Angle Grinder - Druckluft-Winkelschleifer

057753

Ø 100 mm

± 1.6 mm, x5  
057883  
± 0.8 mm, x5  
058217



Speed	Power	Air consumption	Air pressure	Stroke	Weight
rpm	W	l/min	bar	cm	kg
14000	84	113	6.2	37	17

**MINI-MEULEUSE** - Mini disc sander - Druckluftschleifer

051829

Speed adjustment

Ø 75 mm

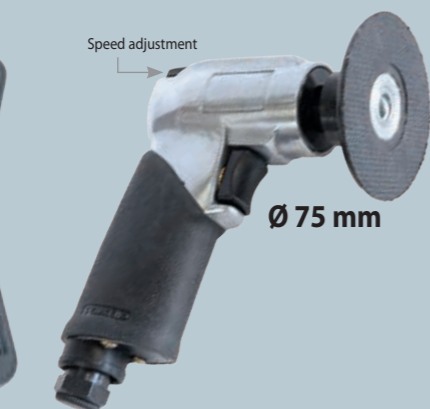

Speed	Power	Air consumption	Air pressure	Stroke	Weight
rpm	W	l/min	bar	cm	kg
18000	200	83	171	12	0.7

Included (x1)  
052468

**MINI-MEULEUSE À RENVOI D'ANGLE** - Mini Angle Grinder - Mini-Druckluftwinkelschleifer geräuschgedämpft

051867

Ø 50 mm

90°



Speed	Power	Air consumption	Air pressure	Stroke	Weight
rpm	W	l/min	bar	cm	kg
15000	200	86	85	18	0.75

058248

x2 Ø  
Ø 50 & 75 mm



Speed	Power	Air consumption	Air pressure	Stroke	Weight
rpm	W	l/min	bar	cm	kg
15000	84	91	6.2	10	0.6

MINI-FLEXIDISC LAMELLES ZIRCON  
Ø 50 mm  
K 40 (x10) 058255  
K 60 (x10) 058262  
K 80 (x10) 058279

**SCIE COUPE TÔLE DROITE ET LIME** - Saw for Straight Cut and File - Druckluftsäge und Feile

051805

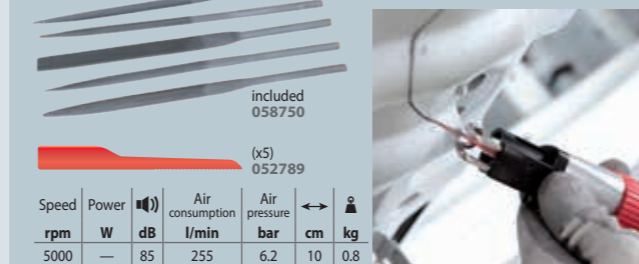

Speed	Power	Air consumption	Air pressure	Stroke	Weight
rpm	W	l/min	bar	cm	kg
5000	—	85	255	10	0.8

Included  
058750

(x5)  
052789

**COFFRET DÉCAPEUSE PNEUMATIQUE** - Pneumatic surface remover Kit - Druckluftentroster-Box inkl. Zubehör

051775



Speed	Power	Air consumption	Air pressure	Stroke	Weight
rpm	W	l/min	bar	cm	kg
4000	500	86	102	280	1.2

**PINCE À SOYER ET À TROUVER, Ø5MM PNEUMATIQUE** - Pneumatic flange / ø5 mm punching tool - Pneumatische Loch- und Absetzzange Ø 5 mm

052543

Ø 5 mm

2 in 1

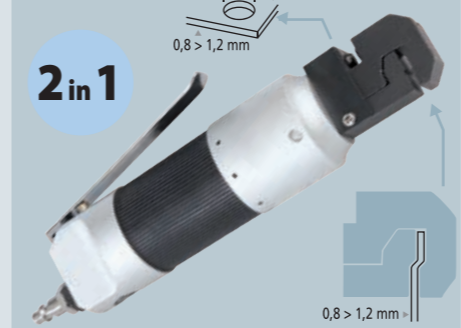

**POINÇONNEUSE PNEUMATIQUE OBLONG** - Pneumatic oval punching tool - Pneumatische Langloch-Blechzange



052437

Uтил DE POINÇONNAGE OBLONGS - Punching tool for oval holes - Langlochkarosserieblechzange

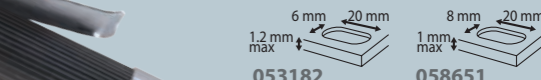

for MIG brazing

Included  
6x20 8x20  
53515 53516

**DÉPOINTEUSE** - Spot remover - Druckluft-Schweißpunktbohrer

SPOT DRILL  
050464

Foires de dépointage - Spot remover drill - Schweißpunktfräse  
Tungsten Carbide for BORON/UHSS

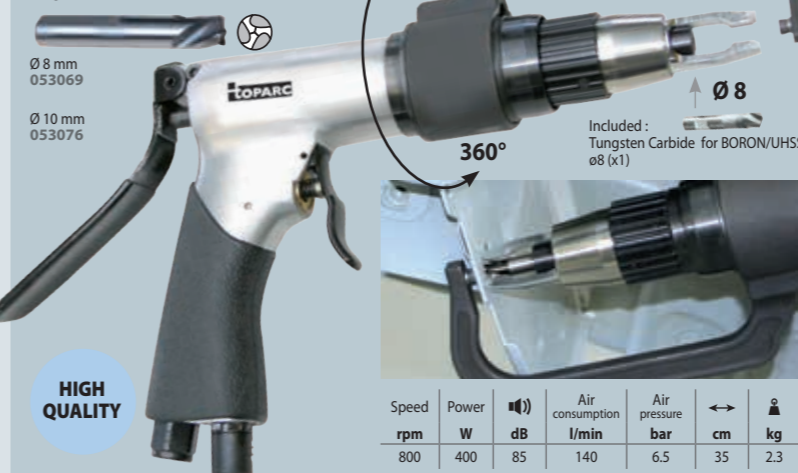

HIGH QUALITY

Speed	Power	Air consumption	Air pressure	Stroke	Weight
rpm	W	l/min	bar	cm	kg
800	400	85	140	35	2.3

**BODY ZIPPER** - Sertisseuse pneumatique  
Pneumatic Crimper - Druckluftkantenformer

056930

MADE IN HIGH QUALITY POLAND

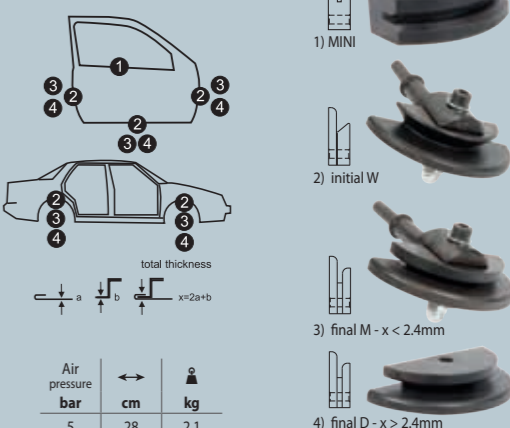

Air pressure	Stroke	Weight
bar	cm	kg
5	28	2.1

**PONCEUSE À BANDE** - Air belt sander - Druckluft Bandschleifer

052819



Speed	Air consumption	Air pressure	Stroke	Weight
rpm	l/min	bar	cm	kg
16000	171	6.3	26	0.9

**MINI-FRAISEUSE À RENVOI D'ANGLE** - Mini Angle Milling Machine - Mini-Winkelschleifer

051836



Speed	Power	Air consumption	Air pressure	Stroke	Weight
rpm	W	l/min	bar	cm	kg
18000	500	81	85	18	0.7

**PERCEUSE MANDRIN AUTOMATIQUE** - Automatic Mandrel Drill - Druckluftbohrmaschine m. Schnellspannfutter

051799

Ø 13



Speed	Power	Air consumption	Air pressure	Stroke	Weight
rpm	W	l/min	bar	cm	kg
800	300	92	170	18	0.9

**DÉPOINTEUSE POUR CORDON LASER ACIER & ALU** - Laser cord metal sheet cutter (nibbler) - Trennwerkzeug für Lasernähte

054165

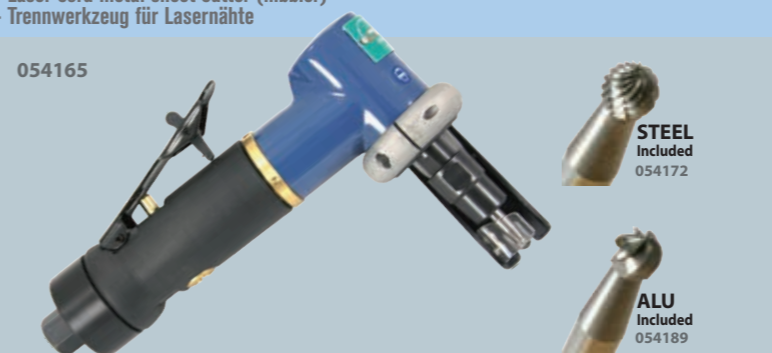

STEEL Included  
054172

ALU Included  
054189



**TOURNEVIS SANS FIL**  
- Cordless Mini Screwdriver - Akkuschauber

057944  
LO speed : 220 rpm - 4 Nm  
HI speed : 450 rpm - 2.7 Nm  
3.6 V - 1.5 Ah Li-ion battery  
430 g  
■ 295 x 290 x 90 mm

135 mm  
90°  
150 mm  
53527

**TOURNEVIS À CHOCS SANS FIL**  
- Cordless Impact Screwdriver - Akkuschauber

057951  
Speed : 2400 rpm  
117 Nm max  
14.4 V - 2 Ah Li-ion battery  
1.1 kg  
↓ 155 x 63 x 210 mm  
■ 295 x 290 x 90 mm

53526

**VISSEUSE/DÉVISSEUSE SANS FIL**  
- Cordless Drill/Screw Gun - Akku-Bohr-Schrauber

057937  
LO/HI speed : 340/1400 rpm  
26 Nm max  
14.4 V - 2 Ah Li-ion battery  
1.19 kg  
↓ 199 x 63 x 215 mm  
■ 295 x 290 x 90 mm

Ø 10 mm max  
53526

**RIVETEUSE SANS FIL**  
- Cordless Riveter - Akku-Blindnietgerät

057968  
Rivets Ø 3.2 & Ø 4.0 mm (Ø 4.8 mm alu)  
10.8V - 2 Ah Li-ion battery  
1.16 kg  
Contrôle variable de la vitesse  
Balais remplaçables.  
↓ 247 x 52 x 190 mm  
■ 345 x 280 x 90 mm

Variable speed switch  
Replaceable carbon brush  
53525

**PISTOLET À COLLE SANS FIL** - Cordless Caulking Gun - Akku-Kartuschenpresse

057975

Speed : 3 > 10 mm/s  
Capacity : 400 ml  
14.4V - 2 Ah Li-ion battery  
2.75 kg  
↓ 465 x 130 x 275 mm  
■ 535 x 305 x 156 mm

53528

**MEULEUSE/POLISSEUSE SANS FIL**  
- Cordless sander / polisher - Akku-Polier-Schleifer

057982  
Meuleuse :  
0 > 6900 rpm  
Polisseuse :  
0 > 1900 rpm  
14.4 V - 2 Ah Li-ion battery  
1.08 kg  
↓ 150 x 63 x 215 mm  
■ 395 x 325 x 100 mm

included  
75 mm  
50 mm  
53526

**PONÇEUSE /POLISSEUSE ÉLECTRIQUE** - Electric Sander & Polisher - Elektro-Polier-Schleifer

057999  
Orbital 5.0 mm  
↓ 303 x 101 mm  
1.21 kg  
Speed : 4000, 7000, 9000 10000 rpm  
AC-in 220V - 230V / 50 - 60Hz

Light weight  
& Compact  
No vibration  
Ø 152 mm

Speed control  
Ø 35 mm  
4m  
Input Ø 32 mm  
Mains cable length 4.5m

058293  
Manual or automatic  
Power supply : 230V / 50Hz  
Power : 1400W (max 2000W)  
Max. vacuum : 170 mbar  
Air flow : 2700 l/min  
Drum capacity : 30 l  
Drum material : stainless steel  
↓ 380 x 380 x 700 mm  
▲ 7 kg

NEW 2018

**DETAILING & COLOUR MATCH** - Farbanpassung & Aufbereitung

**SUN COLOR**  
Ultra high CRI > 95 COB LED  
4500 K  
1100 lux  
400 lumen  
IP 65  
4h operation time  
3.7 V - 2600 mAh Li-ion battery  
058477

**SUNMATCH 2**  
Ultra high CRI+ COB LED  
4500/6500 K  
1100-550 lux (step 1-step 2)  
500-250 lumen (step 1-step 2)  
IP 65  
1h/2h operation time  
3.7 V - 2600 mAh Li-ion battery  
057777

WARM 4500 K  
COLD 6500 K

100%  
R1 R2 R3 R4 R5 R6 R7 R8 R9 R10 R11 R12 R13 R14 R15  
CRI CRI+

SCANGRIP  
COLOUR MATCH  
Discover it on Youtube

**LAMPES LED** - LED Lights - Arbeitsleuchte - Lámpara - Lampada - Werk lamp

4W COB LED work light  
1W top LED  
Li-ion battery  
Charging time : 8h

**HIGH position :**  
2.5 h operating time

**LOW position :**  
5 h operating time  
Top LED : 6 hours

3 strong magnets  
2 swivel hooks

NEW 03/2018

059153

120 LEDs  
800 lumen  
3h/6h operating time  
3.7 V - 4000 mAh Li-ion battery  
058002  
058316

115 cm  
15 cm

3x 55 SMD LEDs, total 165 LEDs.  
Brightness 1800 lumens  
1.8m power cord  
Tripod stand with lock Built-in hook.

059146

**ASPIRATEUR PNEUMATIQUE POUR POUSSIÈRES ALUMINIUM (ATEX)**  
- Pneumatic aluminium dust atex vacuum cleaner

058866  
Dust container capacity : 25 l  
Working compressed air pressure : 6 bar  
Compressed air consumption at 6 bar : 800 l/min  
Suction connection diameter size : 50 mm  
Max suction capacity : 150 m<sup>3</sup>/h  
Max vacuum level : 2000 mm H<sub>2</sub>O  
Recommended compressor power : 7.5 HP

↓ 74 x 45 x 45 mm  
▲ 18 kg

5 m  
Output Ø 29 mm  
Input Ø 35 mm

included  
Filtre - Filter  
058873

included  
Sac à poussières - Filter bag  
Capacity 5 kg  
058880

**BALADEUSE LED** - Rechargeable 15W Portable LED Lamp with Magnetic Stand - LED-Akkuarbeitsleuchte

15W LED COB  
2.5h operating time (Full light)  
12h operating time (Semi light)  
3.7 V, 2200 mAh  
Li-ion battery  
375 x 40 x 30mm  
057760  
058309

180°  
360°  
USB charge

included



**TRÉTEAUX - Frames support - Klappbücke**

040601  
100.5 x 112 cm - 5.5 kg  
35 x 95 x 106 cm

040311  
104.5 x 117 cm - 8.1 kg  
32 x 10 x 106 cm

040250  
100 x 105 cm - 7 kg  
32 x 10 x 106 cm

040304  
104.5 x 108.8 cm - 8.1 kg  
32 x 10 x 106 cm

4 pieds coudés  
Idéal sur callebotis  
- Bent feet for grating  
- Abgewinkelte Standfüße:  
Sicherer Stand auf Gittern u.ä.

Ø28 mm

Ø32 mm

Ø32 mm

Ø32 mm

4 ventouses  
Dépose vitrages  
- Suction pad for glazing  
- Gummiteiler zur Fixierung  
von Glasscheiben

Chainette réglable  
- Adjustable catenary

Mousse de protection  
- Protecting foam

Antidérapants  
- Non-slip base

Léger et très maniable  
Spécial travaux à l'horizontal  
- Light and easy to handle  
Ideal for horizontal works  
- Speziell geeignet für Arbeiten  
in horizontaler Position

**SUPPORT ÉLÉMENT ROTATIF**

- Rotary element support - Lackierständer für Stoßstange, einstellbar

052611  
200 x 101 cm - 17.5 kg  
35 x 15 x 110 cm  
Made in China

1.5 mm

2 mm

360°

Verrouillage de l'axe  
- Locking of the axis  
- Verriegelung der Achse

MADE IN HIGH QUALITY POLAND

PRO  
056725  
200 x 105 x 81 cm - 22 kg  
24 x 17 x 118 cm

**SUPPORT PARE-CHOCs - Rotary element support - Lackierständer für Stoßstange, einstellbar**

052376  
91 x 105 cm - 7.6 kg  
60 x 11 x 75 cm

Adapté aux coques de rétroviseurs  
- Adapted to wing mirror covers  
- Geeignet für Außenspiegel

**TIGES DE BLOCAGE - Flap Lock**

056732

30 > 115 cm

**CHARIOT DE LUXE MAROUFLAGE**

- Premium masking machine - Abdeckpapier-Ständer

MADE IN HIGH QUALITY POLAND

x 5  
rouleaux de papier  
- Papierständer  
- Paper roll  
30 > 120 cm

057333  
150 x 133 x 62 cm  
32 kg  
152 x 17 x 29 cm

Ø40 mm  
x 6  
058897

**CHARIOT DE MAROUFLAGE**

- Masking machine - Abdeckpapier-Ständer

MADE IN HIGH QUALITY POLAND

x 3  
rouleaux de papier  
- Papierständer  
- Paper roll  
30, 60, 90 cm

056954  
150 x 62 x 110 cm  
- 12 kg  
122 x 29 x 17 cm

**CHARIOT DE STOCKAGE**

- Storage trolley - Lagerrollwagen

040243

71 x 90 x 197 cm  
41 kg  
x2:  
91 x 147 x 6 cm  
+ 69 x 93 x 44 cm

**CHARIOT DE VISITE - Mechanics Creeper With Tilting Headrest - Werkstatt-Rollliege**

057548  
102 x 43 x 11 cm  
7.2 kg  
11 x 44 x 13 cm

**TABOURET**

- Round Stool with Tool Storage - Werkstatt-Rollhocker

057555  
38 x 38 x 44 cm - 6 kg  
40 x 40 x 18 cm

**LÈVE ROUE SUR BATTERIE**

- Wheel lift trolley with battery  
- Radmontage-Heber mit Akkubetrieb

058545  
98 kg  
66 x 69 x 172 cm  
80 x 80 x 180 cm - 112 kg

2 x 12 V/12 Ah  
Integrated charger (16 A)

35 > 340 mm max

500 > 800 mm

60 kg max

400 mm

130 mm

**MARCHE PIED - Folding Step Stool (Aluminium) - Arbeitspodest klappbar**

ALU 200 kg

960 mm

385 mm

475 mm

057562  
8.2 kg  
102 x 41 x 59 cm

ALU 150 kg

1090 > 1750 mm

520 > 900 mm

300 mm

058552  
15.5 Kg  
116 x 43 x 17 cm - 16.5 kg

**COUVERTURE ANTI-CHALEUR** - Heat cover - Hitzeschutzdecke - Manta anti-calor - Protecção anti-aquecimento



PROTEC 550  
550°C/1000°F - Class M0  
2 m x 2 m - 580 g/m<sup>2</sup>  
050495

PROTEC 1200  
1200°C/2200°F - Class M0  
1.75 m x 1.5 m - 1200 g/m<sup>2</sup>  
050204

PROTEC 1300  
1300°C/2400°F - Class M0  
XL: 2 m x 1.8 m - 620 g/m<sup>2</sup>  
053595

PROTEC 1300L  
1300°C/2400°F  
XL: 2 m x 1.8 m - 427 g/m<sup>2</sup>  
060500

**JEU DE 2 AIMANTS**  
- Set of 2 magnets -  
Schweißmagnet



(x2)  
052291

**RIDEAU DE SOUDAGE**  
- Welding curtain and frame -  
Schweißerschutzwand

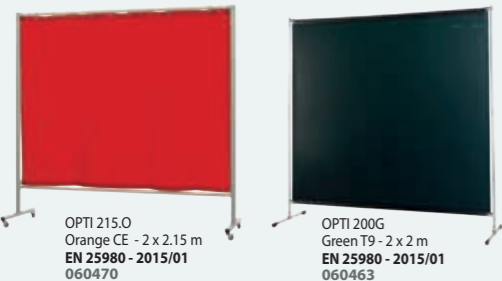

OPTI 215.0  
Orange CE - 2 x 2.15 m  
EN 25980 - 2015/01  
060470

OPTI 200G  
Green T9 - 2 x 2 m  
EN 25980 - 2015/01  
060463

**LUNETTES DE PROTECTION** - Protection goggles - Schutzbrillen

Antiprojection/meulage - Anti-projection/  
grinding - Anti-proyección/amoladura -  
Spritzschutz/Schleifen

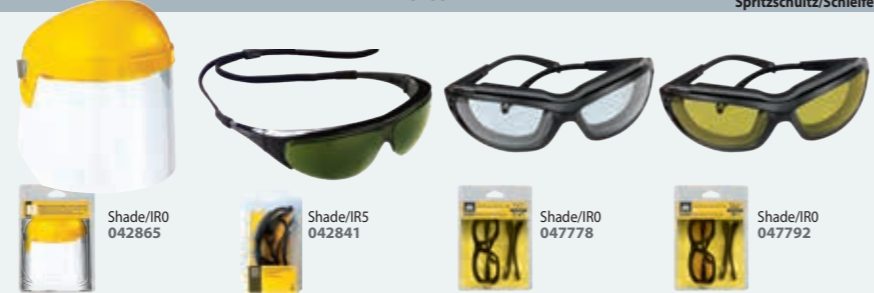

Shade/IR0  
042865

Shade/IR5  
042841

Shade/IR0  
047778

Shade/IR0  
047792

**MASQUES RESPIRATOIRES** - Respiratory masks - Atemschutzmaske - Máscaras respiratorias



FFP3 - EN 140 / EN 143 / EN 166  
(x1) Size M/L  
037021

FFP3 - EN 140 / EN 143  
(x1) Size M/L  
037014

Étui / Case  
037045

FFP3 - EN 143 - 2000 P3  
Anti poussières / Anti odeurs  
037038

FFP1  
(x20) EN 149-2001  
043916

FFP2D-OV  
M/L (x5) EN 149-2001  
043923

**VESTE** - Jacket - Jacke

**PANTALON** - Trouser - Hose

**TABLIER CUIR MULTI-USAGE**  
- Multi-use leather apron -  
Delantal de cuero multi-uso -  
Mehrzweck-Lederschürze

**GANTS** - Gloves - Handschuhe - Guantes



98% cotton, 2% antistatic  
S (40/42) 046313  
M (44/46) 046320  
L (48/50) 046337  
XL (52/54) 046344  
XXL (56/58) 046351

98% cotton,  
2% antistatic  
S (40/42) 046368  
M (44/46) 046375

L (48/50) 046382  
XL (52/54) 046399  
XXL (56/58) 046412



PRO  
045217



EN ISO 11612:2008  
A1+A2-B1-C1-E3-F1

EN ISO 11611:2007  
Class 2-A1 & A2

IEC 61482-2:2009  
Class 1-4KA

EN 1149-5:2008

EN 14404:2004  
-A1-2010  
Type 2

EN388:  
2003  
4244

EN12477:  
2001  
4244XX

Heavy Duty  
T10  
(MIG - Plasma)  
045101

Gants de soudage  
Renforcés  
- Reinforced  
welding gloves:  
T10  
045873

Gants Manutention  
Anti coupeure  
- Anti-cut handling  
gloves:  
EN388:4343  
T9  
045897

Anti coupeure haute  
résistance - High  
resistance anti-cut  
handling gloves:  
EN 420  
EN 388:3131  
T9:  
045910

Anti coupeure haute  
dextérité - High  
precision anti-cut  
handling gloves:  
EN 420  
EN 388:3111  
T9:  
045903

T10:  
045934

**ASPIRATEURS DE FUMÉE** - Fume Extraction Systems - Rauchgasabsauggerät



• 230V / 1 ~ / 50 Hz  
• 2 x 1000 W  
• AUTOMATIC ON/OFF  
039896

2.5 m  
(included)

• 230V / 1 ~ / 50 Hz - 32A  
• 1100 W  
• 1200 m<sup>3</sup>/h max  
• arm 3 m  
• included  
• 85 kg  
046474

Breveté - Patented  
Welding detection  
Automatic ON/OFF  
230 V connection

792 mm

347 mm

Options

Automatic ON/OFF  
Manual 043237  
043244

150 A, 3m, Grip 043251

039889

5 m (included)  
040656

039872

040649  
039865

040649  
(included)

046498

046443

856 mm

506 mm

835 mm

Filtre - Filter  
(included)  
046467

**BATTERY SUPPORT UNIT (BSU)  
BATTERY CHARGER**



MADE IN FRANCE

	<b>GYSFLASH 30.12 HF</b>	30 A	12 V
		029224	
	<b>GYSFLASH 30.24 HF</b>	30 A	6/12/24V
		029231	
	<b>GYSFLASH 40.12 FV</b>	40 A	12 V
		029064	
	<b>GYSFLASH 50.12 HF</b>	50 A	12 V
		029088	
	<b>GYSFLASH 50.24 HF</b>	50 A	6/12/24V
		029095	
	<b>GYSFLASH 100.12 HF</b>	100 A	12 V
		029071	



RENAULT  
1 044 40004

10.5 cm

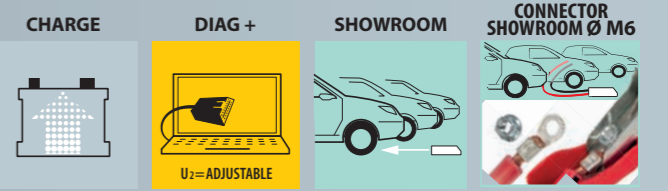

**TECHNOLOGY & ADVANTAGES**

**AUTO DETECT**  
Protection for on-board electronics

**MICRO-PROCESSOR CONTROL**

**100%**  
50% de gain de temps + batterie chargée à 100%  
50% of time saved + battery 100% charged  
50% Zeitersparnis + 100% Vollladung  
ahorro de tiempo de 50% + batería cargada a los 100%

**HIGH EFFICIENCY**  
Up to 15% Energy Saving **93%**

**EMC class B**

**PFC POWER FACTOR CORRECTION**  
185V  
265V  
100m

**EASY MODE**

**FAN LESS TECHNOLOGY**

**SULPHATED BATTERIES**  
AUTOMATIC RECOVERY



**CHARIOT - TROLLEY - FAHRWAGEN**  
029491



**VALISE DE CHANTIER / HEAVY-DUTY CASE / HARTSCHALENKOFFER**  
060432  
21 x 43 x 57 cm / 3.9 kg



**TABLETTE / WALL SUPPORT / WANDHALTERUNG**  
055513



**EXTENSIONS CABLES**  
Gysflash 30/40/50/100/102  
5 m - 16 mm<sup>2</sup>  
054615  
8 m - 16 mm<sup>2</sup>  
056572





# GYS Academy

Centre de formation agréé  
Training centre dedicated to professionals  
Trainingcenter für Profis

Formations agréées  
Ref. 52.53.0068153

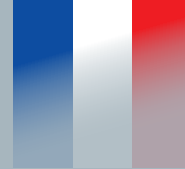

MADE IN FRANCE  
SINCE 1964

## 🇫🇷 GYS France (HQ)

BP 4159  
53941 Saint-Berthevin  
ZI, 134 bd des Loges  
Laval - France

Tel : +33 2 43 01 23 60  
E-mail : [contact@gys.fr](mailto:contact@gys.fr)

## 🇩🇪 GYS Germany

Professor-Wieler-Straße 11  
52070 Aachen  
Deutschland

Tel : +49 241 / 189-23-710  
Fax : +49 241 / 189-23-719  
E-mail : [aachen@gys.fr](mailto:aachen@gys.fr)

## 🇬🇧 GYS UK

Unit 3  
Great Central Way  
Rugby - Warwickshire - CV21 3XH  
United Kingdom

Tel : +44 1926 338 609  
Fax : +44 1926 429 764  
E-mail : [uk@gys.fr](mailto:uk@gys.fr)

## 🇮🇹 GYS Italia

Vega - Parco Scientifico Tecnologico di Venezia  
Via Delle Industrie, 25/4  
30175 Marghera - VE  
Italia

Tel : +39 340 3677916  
E-mail : [italia@gys.fr](mailto:italia@gys.fr)

## 🇨🇳 GYS China

Lot N°15  
6666 bd Songze  
201706 Qingpu Shanghai  
China

Tel : +86 6221 4461  
Fax : +86 5226 0067  
[www.gys-china.com.cn](http://www.gys-china.com.cn)  
E-mail : [contact@gys-china.com.cn](mailto:contact@gys-china.com.cn)

## 🇨🇳 Bao Zhi Long Electrical Equipment (JV GYS)

Building C1,  
No. 479 Chundong Rd  
Minhang District, Shanghai  
China

Tel : +86 52217650  
Tel2 : +86 52217651  
Tel3 : +86 52217652  
Fax : +86 52217653  
[www.bzl-china.com](http://www.bzl-china.com)  
E-mail : [mz@bzl-china.com](mailto:mz@bzl-china.com)

[www.gys.fr](http://www.gys.fr)

Videos



Distributed by

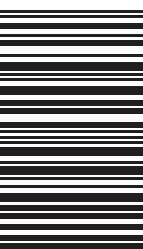

Document non contractuel. GYS se réserve le droit de modifier sans préavis les spécifications de ses appareils - Document not contractual. GYS reserves the right to modify the specifications of the machines without prior notice. Irrtümer und Änderungen vorbehalten.