



Manufacturing in Italy *since 1981*

**CASA**

*Home*

**FERRAMENTA**

*Hardware*

**PAVIMENTI**

*Flooring*

**AUTO-BICI**

*Automotive*

**ANIMALI**

*Pet*

**GIARDINO**

*Garden*

EDIZIONE  
**2024**

**CATALOGO PRODOTTI**

*Product Catalogue*



*“Miglioriamo la tua vita,  
organizzando i tuoi spazi.”*

*“We improve your life, organizing your space”*



**IL 90% DEI NOSTRI PRODOTTI  
È REALIZZATO CON PLASTICA RIGENERATA**

*90% of our products are made with regenerated plastic*

■ Linea <b>EASY</b> 14 > 15		■ Linea <b>FREE</b> 16 > 17	
■ Linea <b>FAMILY</b> 18 > 19		■ Linea <b>IDEA</b> 20 > 21	
■ Linea <b>SPAZIO</b> 22 > 23		■ Linea <b>STEEL</b> 24 > 25	
■ Linea <b>EVOLUTION</b> 26 > 29		■ Linea <b>CONCERT</b> 30 > 35	
■ Linea <b>CUBE</b> 36 > 37		■ Linea <b>RATTAN</b> 38 > 39	
■ Linea <b>UNIKA</b> 40 > 41		■ Linea <b>FLIP FLAP</b> 42 > 43	
■ Linea <b>BAGNO</b> 50 > 53		■ Linea <b>ENJOY</b> 46 > 49	
■ Linea <b>MIOBOX</b> 58 > 61		■ Linea <b>TUOBOX</b> 54 > 57	
■ Linea <b>PELLETBOX</b> 66 > 67		■ Linea <b>EUROBOX</b> 62 > 65	
■ Linea <b>LABELLING</b> 70 > 73		■ Linea <b>DOLLY</b> 68 > 69	
■ Linea <b>TEMPO</b> 76 > 79		■ Linea <b>FLEXBAG</b> 74 > 75	
■ Linea <b>DAVIDE D+</b> 84 > 86		■ Linea <b>TEMPO PLUS</b> 80 > 83	
■ Linea <b>DOLLY</b> 88 > 93		■ Linea <b>SHEEL</b> 87	
■ Linea <b>FREE ECO</b> 96 > 97		■ Linea <b>EASY ECO</b> 94 > 95	
■ Linea <b>IDEA ECO</b> 100 > 101		■ Linea <b>FAMILY ECO</b> 98 > 99	
■ Linea <b>BIOSYSTEM</b> 106 > 111		■ Linea <b>ECO-LOGICO</b> 102 > 105	
■ Linea <b>UFFICIO</b> 114 > 117		■ Linea <b>ECOTRESPOLO</b> 112 > 113	
		■ Linea <b>MIP</b> 118 > 119	

## FERRAMENTA | Hardware

■ Linea **VALENTINO**

120 > 127



■ Linea **PANNELLI**

132 > 137



■ Linea **VARIOBOX**

148 > 155



■ Linea **UNIVERSAL BOX**

160 > 161



■ Linea **TROLLEY-SHOP**

174 > 175



■ Linea **STORE**

186 > 189



■ Linea **PICK**

192 > 199



■ Linea **TEKNA**

128 > 131



■ Linea **VALENTINO**

138 > 146



■ Linea **CONTENITORI**

156 > 159



■ Linea **ALEDAN**

162 > 173



■ Linea **EUROBOX**

176 > 185



■ Linea **FIBRA**

190 > 191



■ Linea **SUPER-PICK**

200 > 201



## AUTO-BICI | Automotive

■ Linea **VOYAGER**

202 > 205



■ Linea **CARBON**

206 > 219



## PAVIMENTI | Flooring

■ Linea **TENAX**

220 > 233



■ Linea **GARDEN STONE**

238 > 239



■ Linea **COMBIWOOD**

242 > 245



■ Linea **STONESTYLE**

248 > 249

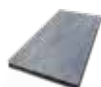

■ Linea **STRIPED**

252 > 253



■ Linea **EASY**

258 > 261



■ Linea **FLEXTILE**

270 > 271



■ Linea **SALVAPRATO**

274 > 275

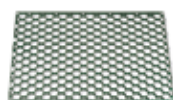

■ Linea **ANTI TRAUMA**

234 > 237



■ Linea **MEGA TILE**

240 > 241



■ Linea **WOODENSTYLE**

246 > 247



■ Linea **WOODENLIKE**

250 > 251



■ Linea **COMBI**

254 > 257



■ Linea **MARTE**

262 > 269

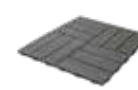

■ Linea **ROMBO**

272 > 273



■ Linea **PREMIUM**

276 > 279



## ANIMALI | *Pet*

■ Linea **CUCCE**  
280 > 281



■ Linea **TRASPORTINI**  
282 > 284



■ Linea **CIOTOLE**  
285



■ Linea **PETBOX**  
286 > 287



## GIARDINO | *Garden*

■ Linea **HARD TOP**  
288 > 297



■ Linea **CLEAN**  
298 > 299



■ Linea **BORDURE**  
300 > 307



■ Linea **GARDEN SHED**  
308 > 313



■ Linea **INFINITY**  
314 > 323



■ Linea **GARDEN TOOLS**  
324 > 331



■ Linea **PALE DA NEVE**  
332 > 335



■ Linea **POP-UP**  
336 > 339



■ Linea **SMILE**  
340 > 341



■ Linea **BASKET**  
342 > 343



■ Linea **TOTEM**  
344 > 347



■ Linea **LOLEGO**  
348 > 359



■ Linea **CILINDRO**  
360 > 365



■ Linea **CAMPANA**  
366 > 367



■ Linea **QUADRO MAXI**  
368 > 369



■ Linea **CASSETTA MAXI**  
370 > 371



■ Linea **OLIMPO**  
372 > 375



■ Linea **DÉCO**  
376 > 379



■ Linea **ORCHIDEA**  
380 > 381



■ Linea **SOTTOVASI**  
382 > 385



■ Linea **NOVA VITA**  
386 > 405



## SCAFFALI | *Shelves*

■ Layout **SCAFFALATURE**  
406 > 421



# Stabilimenti

## Factories



1

### SITO / SITE

Stabilimento  
Factory

**Nicorvo**  
27020-(PV) Via Robbio, 6



VAI A:  
GO TO:



2

### SITO / SITE

Stabilimento  
Factory

**Palestro**  
27030-(PV) Via Confienza, 17



VAI A:  
GO TO:



3

### SITO / SITE

Uffici e Stabilimento  
Offices & Factory

**Robbio**  
27038-(PV) Via Enrico Mattei, 11



VAI A:  
GO TO:



4

### SITO / SITE

Polo logistico  
Logistical Hub

**Sant'Angelo Lomellina**  
27030-(PV) Via Dott. Mazzini, 1



VAI A:  
GO TO:



5

### SITO / SITE

Magazzino  
Warehouse

**Rosasco**  
27030-(PV) Via Castelnovetto 8/12



VAI A:  
GO TO:



6

### SITO / SITE

Uffici e Magazzino  
Offices & Warehouse

**Robbio**  
27038-(PV) Via Mortara, 71/73



VAI A:  
GO TO:



Siamo qui  
We are here

**Pavia**



- ✈ **Malpensa** 50 Km
- Milano** 75 Km
- ✈ **Linate** 85 Km
- Torino** 90 Km



# La nostra storia

## Our history





Art Plast si trova in alta Lomellina, un mosaico di acqua e di terra, una superficie liscia e piana costellata da risaie e grandi cascine.

Fondata nel 1981 da Dino Baraggioli, si dedica inizialmente allo stampaggio per conto terzi. Grazie all'esperienza acquisita, inizia ben presto la produzione di articoli propri.

Nel 1989 espone per la prima volta alla Fiera Internazionale di Colonia, acquisendo clienti italiani ed europei di primaria importanza, che ancora oggi vanta.

Art Plast si estende su un'area di oltre 142.000 mq, di cui 41.000 coperti, suddivisi in 6 unità: 3 sono produttive 24 ore al giorno, due centri logistici e un centro di confezionamento.

L'azienda investe costantemente in macchinari, stampi e nuove tecnologie, come lo stampaggio ad iniezione con azoto e "l'in-mould labelling".

Inoltre Art Plast ha un'officina meccanica interna per la costruzione di stampi e la loro manutenzione. Tutti gli articoli presenti a catalogo, la cui produzione è destinata al 50% all'estero e 50% in Italia, sono prodotti da Art Plast in Italia.

*Art Plast is located in the upper Lomellina, a mosaic of water and earth, smooth and flat territory dotted with rice paddies and large farmhouses.*

*Art Plast is a Company established by Dino Baraggioli in 1981. The firm first moulded on behalf of third party, activity that enabled the Company to start with its own production. In 1989 Art Plast exhibited at the Hardware and Diy Fair in Cologne, dealing with the most important European Customers, that still holds. Today owns 41.000 square meters of buildings divided into 6 units: 4 productive 24 hours a day and one is a logistics center, over a total area of over 142.000 square meters. Every year Art Plast invests in new injection machines, new molds and in new molding technologies, such as gas assist injection molding and in-mould labelling. Art Plast has moreover an inside mechanical workshop for the construction of the molds and their maintenance.*

*All the products present on our catalogue are manufactured in Art Plast, in Italy, whose production is destined to 50 % abroad and 50% in Italy.*



**Visione**  
**Missione**  
**Valori**

Vision  
Mission  
Values

## **VISIONE**

Vogliamo contribuire con il nostro operato alla creazione di un mercato di concorrenza leale, offrendo prodotti che apportino reali benefici e soddisfazioni al Cliente finale in ambito privato e professionale.

## **VISION**

*We would like to create with our work a market of fair competition by offering products that provide real benefits and customer satisfaction to the end user, researched and selected according on their real professional, leisure and home needs.*

## **MISSIONE**

Ci piace pensare che, grazie ai nostri prodotti, miglioriamo e semplifichiamo la vita delle persone, organizzando gli spazi, realizzando prodotti semplici e di grande utilità con un ottimo rapporto qualità prezzo. I nostri prodotti sono rivolti ad un target molto ampio, da chi si cimenta saltuariamente nei lavori del fai-da-te, ai liberi professionisti di ogni settore.

## **MISSION**

*We aim to improve and simplify people life, organizing the space, producing simple and very useful products with excellent value for money. Our products are addressed to a wide target of end users: from who occasionally dabbles in DO-IT-YOURSELF to professional job in every field.*

## **VALORI**

La nostra storia è la testimonianza di passione, onestà e ambizione, con una continua e crescente attenzione per l'ambiente.

## **VALUES**

*Our history is a demonstration of passion, honesty and ambition, with an incessant and growing care for the environment.*





**Prodotti  
Eco-sostenibili  
e italiani**

Eco-sustainable  
and italian  
products

## **ECO-SOSTENIBILITÀ**

Applichiamo una politica aziendale fortemente incentrata sullo “sviluppo sostenibile”, che consiste in una crescita economica e sociale dell’attuale generazione, senza compromettere il futuro delle generazioni successive, mantenendo un sostanziale equilibrio tra ecologia, equità ed economia. Da sempre molto sensibili al problema dell’impatto ambientale e alla tutela della salute del consumatore, abbiamo impostato un piano d’azione, già portato a termine, per rispettare il regolamento REACH.

## **ECO-SUSTAINABILITY**

*We applies a corporate policy strongly focused on “sustainable development”, which consists of an economic and social growth of the today’s generation without compromising the future generations, maintaining a basic balance between ecology, equity and economy. We has been always very sensitive to the environmental and health protection of consumers and to ensure compliance with the rules and comply with REACH.*

## **ITALIANITÀ**

I nostri prodotti sono interamente realizzati in Italia con plastica riciclata, italiana, 100% riciclabile. Si possono definire a Km Zero in quanto uno dei nostri obiettivi è quello di far percorrere alle materie prime e ai loro derivati il minor numero di Km possibile. Selezioniamo preferibilmente fornitori con siti produttivi limitrofi a quelli di Art Plast. I nostri sei siti aziendali distano meno di 7 Km l’uno dall’altro e tendiamo sempre ad accorpate le consegne, anche tramite poli logistici dedicati, per occupare al meglio gli spazi.

## **ITALIANITY**

*Our products are entirely produced in Italy with recycled, Italian and 100% recyclable plastic. Can be defined as zero-kilometers goods because one of the most important targets for us is to move the material and its derivatives for the minimum number of kilometers. In preference we select suppliers with production sites neighboring those of Art Plast. The six plants of the Company are about 7 kilometers from each other and we always try to unify the deliveries, also through dedicated logistic poles to optimize the spaces.*



# Linea **EASY**

Piano superiore portante che copre il bordo dell'anta, per una migliore tenuta contro le infiltrazioni dell'acqua  
*The top shelf covers the borders of the doors, for a better capacity against the seepages of water*

Maniglia verticale  
*Vertical handle*



Ripiani regolabili in altezza che consentono l'ottimizzazione degli spazi interni

*Adjustable shelves allow the customer to optimize the space*

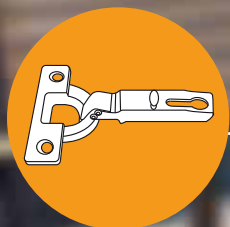

Cerniera in acciaio  
*Steel hinges*

Immagine su due lati, packaging ingegnerizzato per contenere al minimo il volume del prodotto e i costi di trasporto

*Dual-front illustration, engineered packing to reduce the volume of the products and then the freight costs*



20Kg

20Kg

20Kg

# > Linea **EASY**

Prodotto italiano ecosostenibile  
Eco-sustainable italian product



prodotto in polipropilene  
produced in polypropylene



non assorbe gli odori  
odor-proof



non trattiene umidità  
doesn't retain humidity



semplice sistema di assemblaggio  
easy assembly system



**E101**



**E71/TP**



**E71/PS**



**E101/B**



**E71/B**



Ripiani aggiuntivi con supporti  
*Additional shelves with mounting supports*

**FRIP/TP**



**E71B/PLUS**

## ARTICOLO / ARTICLE

	Larghezza Width	Profondità Depth	Altezza Height	Codice a barre Barcode
<b>E71/B</b>	680	370	840	8010693100149
<b>E71/TP</b>	680	370	1630	8010693100156
<b>E71/PS</b>	680	370	1630	8010693100163
<b>E101/B</b>	1020	370	840	8010693100187
<b>E101</b>	1020	370	1630	8010693100170
<b>E71/BPLUS</b>	680	370	840	8010693118670
<b>FRIP/TP</b>	615	330	24	8010693090303

## IMBALLO / PACKING

Pz. Pc.	Tipo Type	Larghezza Width	Profondità Depth	Altezza Height
1	cartone/carton	800	135	689
1	cartone/carton	800	196	689
1	cartone/carton	800	196	689
1	cartone/carton	800	140	1025
1	cartone/carton	800	213	1025
1	cartone/carton	800	135	689
2	cartone/carton	55	630	345

Tutte le misure sono espresse in millimetri / All measures are in millimeters

# Linea **FREE**

Piano superiore portante che copre il bordo dell'anta, per una migliore tenuta contro le infiltrazioni dell'acqua  
*The top shelf covers the borders of the doors, for a better capacity against the seepages of water*

Maniglia verticale  
*Vertical handle*

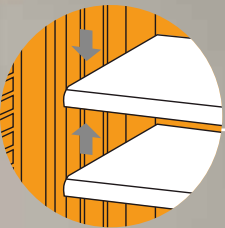

Ripiani regolabili in altezza che consentono l'ottimizzazione degli spazi interni  
*Adjustable shelves allow the customer to optimize the space*

*Adjustable shelves allow the customer to optimize the space*

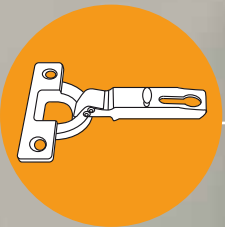

Cerniera in acciaio  
*Steel hinges*

Immagine su due lati, packaging ingegnerizzato per contenere al minimo il volume del prodotto e i costi di trasporto  
*Dual-front illustration, engineered packing to reduce the volume of the products and then the freight costs*

*Dual-front illustration, engineered packing to reduce the volume of the products and then the freight costs*



20Kg



20Kg



20Kg



# > Linea **FREE**

Prodotto italiano ecosostenibile  
Eco-sustainable italian product



prodotto in polipropilene  
produced in polypropylene



non assorbe gli odori  
odor-proof



non trattiene umidità  
doesn't retain humidity



semplice sistema di assemblaggio  
easy assembly system

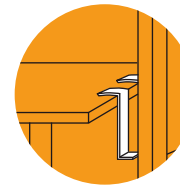

HOME



**F101**



**F71/TP**



**F71/PS**



**F101/B**



**F71/B**

Ripiani aggiuntivi con supporti  
*Additional shelves with mounting supports*



**FRIP/TP**

## ARTICOLO / ARTICLE

	Larghezza Width	Profondità Depth	Altezza Height	Codice a barre Barcode
<b>F71/B</b>	680	370	840	8010693096909
<b>F71/TP</b>	680	370	1630	8010693096701
<b>F71/PS</b>	680	370	1630	8010693096800
<b>F101/B</b>	1020	370	840	8010693097104
<b>F101</b>	1020	370	1630	8010693097005
<b>FRIP/TP</b>	615	330	24	8010693090303

## IMBALLO / PACKING

Pz. Pc.	Tipo Type	Larghezza Width	Profondità Depth	Altezza Height
1	cartone/carton	800	135	689
1	cartone/carton	800	196	689
1	cartone/carton	800	196	689
1	cartone/carton	800	140	1025
1	cartone/carton	800	213	1025
2	cartone/carton	55	630	345

Tutte le misure sono espresse in millimetri / All measures are in millimeters

# Linea **FAMILY**

Piano superiore portante che  
copre il bordo dell'anta, per  
una migliore tenuta contro le  
infiltrazioni dell'acqua

*The top shelf covers the  
borders of the doors, for a  
better capacity against the  
seepages of water*

Maniglia  
verticale  
*Vertical  
handle*

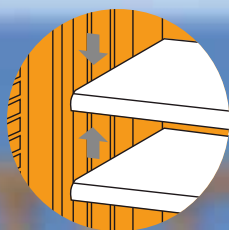

Ripiani regolabili in  
altezza che consentono  
l'ottimizzazione degli  
spazi interni

*Adjustable shelves allow  
the customer to optimize  
the space*



Cerniera in acciaio  
*Steel hinges*

Immagine su due lati,  
packaging ingegnerizzato  
per contenere al minimo  
il volume del prodotto e i  
costi di trasporto

*Dual-front illustration,  
engineered packing to  
reduce the volume of the  
products and then the  
freight costs*



20Kg

20Kg

20Kg

20Kg

Piedini per facilitare la  
pulizia del pavimento  
*Feet to allow an easy  
cleaning of the floor*

# > Linea **FAMILY**

Prodotto italiano ecosostenibile  
Eco-sustainable italian product



prodotto in polipropilene  
produced in polypropylene



non assorbe gli odori  
odor-proof



non trattiene umidità  
doesn't retain humidity



semplice sistema di assemblaggio  
easy assembly system

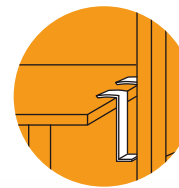

**F100**



**F70/TP**



**F70/PS**



**F100/B**



**F70/B**

Ripiani aggiuntivi con supporti  
Additional shelves with mounting supports



**FRIP/TP**

## ARTICOLO / ARTICLE

	Larghezza Width	Profondità Depth	Altezza Height	Codice a barre Barcode
<b>F70/B</b>	680	370	900	8010693076307
<b>F70/TP</b>	680	370	1690	8010693076505
<b>F70/PS</b>	680	370	1690	8010693076406
<b>F100/B</b>	1020	370	900	8010693087402
<b>F100</b>	1020	370	1690	8010693087501
<b>FRIP/TP</b>	615	330	24	8010693090303

## IMBALLO / PACKING

Pz. Pc.	Tipo Type	Larghezza Width	Profondità Depth	Altezza Height
1	cartone/carton	800	135	689
1	cartone/carton	800	196	689
1	cartone/carton	800	196	689
1	cartone/carton	800	140	1025
1	cartone/carton	800	213	1025
2	cartone/carton	55	630	345

Tutte le misure sono espresse in millimetri / All measures are in millimeters

# Linea **IDEA**

Piano superiore portante che copre il bordo dell'anta, per una migliore tenuta contro le infiltrazioni dell'acqua  
*The top shelf covers the borders of the doors, for a better capacity against the seepages of water*

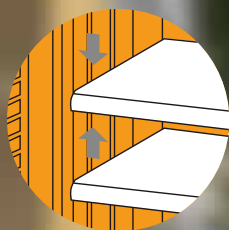

Ripiani regolabili in altezza che consentono l'ottimizzazione degli spazi interni  
*Adjustable shelves allow the customer to optimize the space*

*Adjustable shelves allow the customer to optimize the space*



Cerniera in acciaio  
*Steel hinges*

Maniglia verticale  
*Vertical handle*

Piedini per facilitare la pulizia del pavimento  
*Feet to allow an easy cleaning of the floor*

Immagine su due lati, packaging ingegnerizzato per contenere al minimo il volume del prodotto e i costi di trasporto  
*Dual-front illustration, engineered packing to reduce the volume of the products and then the freight costs*

*Dual-front illustration, engineered packing to reduce the volume of the products and then the freight costs*



# > Linea **IDEA**

Prodotto italiano ecosostenibile  
Eco-sustainable italian product



prodotto in polipropilene  
produced in polypropylene



non assorbe gli odori  
odor-proof



non trattiene umidità  
doesn't retain humidity



semplice sistema di assemblaggio  
easy assembly system



HOME



**I100**



**I70/TP**



**I70/PS**



**I100/B**



**I70/B**



Ripiani aggiuntivi con supporti  
Additional shelves with mounting supports

**FRIP/TP**

## ARTICOLO / ARTICLE

	Larghezza Width	Profondità Depth	Altezza Height	Codice a barre Barcode
<b>I70/B</b>	680	370	900	8010693090501
<b>I70/TP</b>	680	370	1690	8010693090600
<b>I70/PS</b>	680	370	1690	8010693090709
<b>I100/B</b>	1020	370	900	8010693090808
<b>I100</b>	1020	370	1690	8010693090907
<b>FRIP/TP</b>	615	330	24	8010693090303

## IMBALLO / PACKING

Pz. Pc.	Tipo Type	Larghezza Width	Profondità Depth	Altezza Height
1	cartone/carton	800	135	689
1	cartone/carton	800	196	689
1	cartone/carton	800	196	689
1	cartone/carton	800	140	1025
1	cartone/carton	800	213	1025
2	cartone/carton	55	630	345

Tutte le misure sono espresse in millimetri / All measures are in millimeters

# Linea SPAZIO

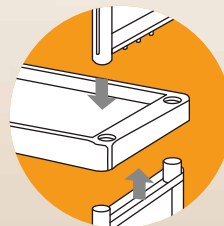

**Nuovo sistema di ripiani integrati in grado di sopportare alti carichi e che garantisce massima stabilità alla struttura**

***New system of integrated shelves, that gives the cabinet a high bearing capacity and stability to the structure***

**L'apertura delle ante non è compromessa dall'eventuale peso posto sul piano superiore, "tetto" del mobile**

***The opening of the doors is not compromised by the eventual weight in the upper shelf***



**Cerniera in acciaio  
Steel hinges**

**30Kg**

**Maniglia orizzontale  
Horizontal handle**

**30Kg**

**30Kg**

**Immagine su due lati, packaging ingegnerizzato per contenere al minimo il volume del prodotto e i costi di trasporto**

***Dual-front illustration, engineered packing to reduce the volume of the products and then the freight costs***



# > Linea **SPAZIO**

Prodotto italiano ecosostenibile  
Eco-sustainable italian product



prodotto in polipropilene  
produced in polypropylene



non assorbe gli odori  
odor-proof



non trattiene umidità  
doesn't retain humidity



semplice sistema di assemblaggio  
easy assembly system

HOME



**S70/PST**



**S70/TPT**



**S70/BT**

## ARTICOLO / ARTICLE

	Larghezza Width	Profondità Depth	Altezza Height	Codice a barre Barcode
<b>S70/BT</b>	700	390	855	8010693117086
<b>S70/TPT</b>	700	390	1650	8010693117093
<b>S70/PST</b>	700	390	1650	8010693117109

## IMBALLO / PACKING

Pz. Pc.	Tipo Type	Larghezza Width	Profondità Depth	Altezza Height
1	cartone/carton	800	400	265
1	cartone/carton	800	400	449
1	cartone/carton	800	400	449

Tutte le misure sono espresse in millimetri / All measures are in millimeters

# Linea **STEEL**

**Nuovo sistema di ripiani integrati in grado di sopportare alti carichi e che garantisce massima stabilità alla struttura**

*New system of integrated shelves, that gives the cabinet an high bearing capacity and stability to the structure*

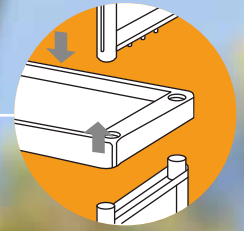

**L'apertura delle ante non è compromessa dall'eventuale peso posto sul piano superiore, "tetto" del mobile**

*The opening of the doors is not compromised by the eventual weight in the upper shelf*

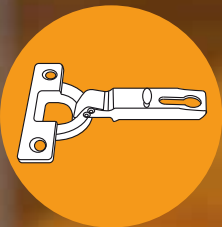

**Cerniera in acciaio**  
*Steel hinges*

**30Kg**

**Maniglia verticale**  
*Vertical handle*

**30Kg**

**30Kg**

**30Kg**

**Immagine su due lati, packaging ingegnerizzato per contenere al minimo il volume del prodotto e i costi di trasporto**

*Dual-front illustration, engineered packing to reduce the volume of the products and then the freight costs*





# > Linea **STEEL**

Prodotto italiano ecosostenibile  
Eco-sustainable italian product



prodotto in polipropilene  
produced in polypropylene



non assorbe gli odori  
odor-proof



non trattiene umidità  
doesn't retain humidity



semplice sistema di assemblaggio  
easy assembly system



**S71/PST**



**S71/TPT**



**S71/BT**

## ARTICOLO / ARTICLE

	Larghezza Width	Profondità Depth	Altezza Height	Codice a barre Barcode
<b>S71/BT</b>	700	390	855	8010693117161
<b>S71/TPT</b>	700	390	1650	8010693117178
<b>S71/PST</b>	700	390	1650	8010693117185

## IMBALLO / PACKING

Pz. Pc.	Tipo Type	Larghezza Width	Profondità Depth	Altezza Height
1	cartone/carton	800	400	265
1	cartone/carton	800	400	449
1	cartone/carton	800	400	449

Tutte le misure sono espresse in millimetri / All measures are in millimeters

# Linea EVOLUTION

Top di gamma degli armadi ArtPlast, la Linea Evolution si scopre alla ricerca di nuove tendenze. Frutto dello studio tecnico e di design, è un armadio dalla linea sobria, elegante e adatta ad ogni ambientazione, senza trascurare le qualità meccaniche e di resistenza.

*Top of the range of ArtPlast cupboards, Linea Evolution is looking on new trends. The result of the technical and design studies is a cabinet with a sober and elegant look suitable in any background without any compromise.*



Design  
tessuto  
*Textile  
design*



Maniglia  
ergonomica  
*Ergonomic  
handle*



Lucchettabile  
*Lockable*



Immagine su due lati, packaging  
ingegnerizzato per contenere al minimo il  
volume del prodotto e i costi di trasporto  
*Dual-front illustration, engineered packing to  
reduce the volume of the products and then  
the freight costs*

# > Linea **EVOLUTION**

Prodotto italiano ecosostenibile  
Eco-sustainable italian product



prodotto in polipropilene  
produced in polypropylene



non assorbe gli odori  
odor-proof



non trattiene umidità  
doesn't retain humidity



semplice sistema di assemblaggio  
easy assembly system

## Caratteristiche principali *Main features*

- Montaggio facile e veloce  
*Easy and fast assembly*
- Lavabile, non assorbe odori e non trattiene l'umidità  
*Washable, don't absorb smells and don't keep humidity*
- Alta stabilità e portata dei ripiani  
*High stability and load bearing capacity of the shelves*
- Prodotto in polipropilene, materiale antiurto, resistente al freddo, alle intemperie, agli oli e ai solventi  
*Produced in polypropylene, shock proof materials, water proof and resistant against solvents and oils*

## **EVO70/TPT** **ARMADIO ALTO** *HIGH CABINET*

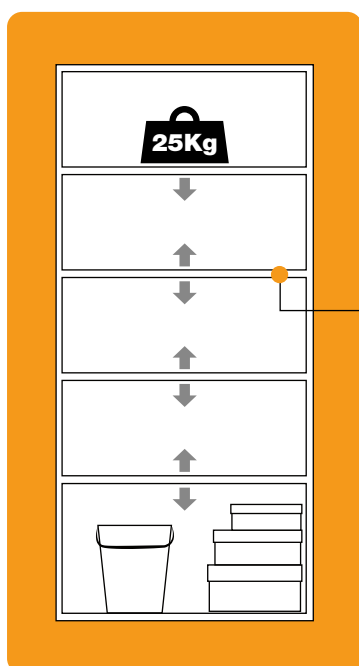

Ripiani regolabili in altezza  
*Shelves adjustable in height*

# > Linea **EVOLUTION**



**EVO70/PST**

**ARMADIO PORTASCOPE**  
*BROOM-HOLDER CABINET*

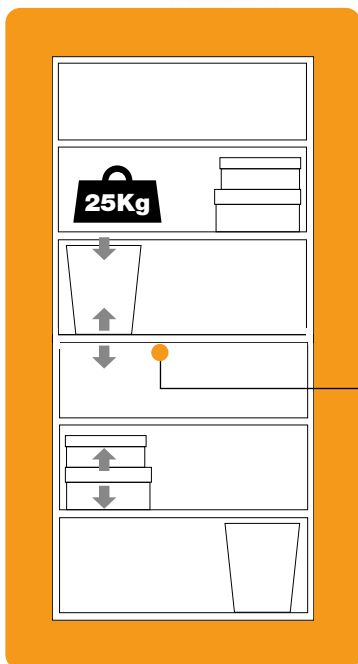

Ripiani regolabili in  
altezza

*Shelves adjustable  
in height*



prodotto in polipropilene  
produced in polypropylene



non assorbe gli odori  
odor-proof



non trattiene umidità  
doesn't retain humidity



semplice sistema di assemblaggio  
easy assembly system

Prodotto italiano ecosostenibile  
Eco-sustainable italian product



**EVO70/BT**

**ARMADIO BASSO**

LOW CABINET

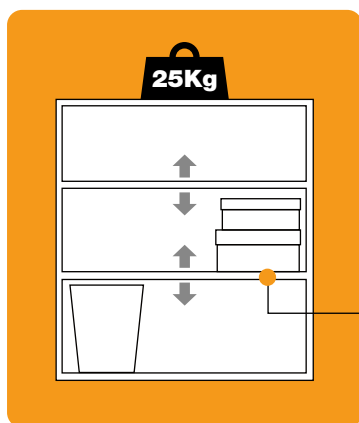

Ripiani regolabili in altezza

*Shelves adjustable in height*



**ARTICOLO / ARTICLE**

	Larghezza Width	Profondità Depth	Altezza Height	Codice a barre Barcode
<b>EVO70/BT</b>	700	470	970	8010693117116
<b>EVO70/TPT</b>	700	470	1840	8010693117123
<b>EVO70/PST</b>	700	470	1840	8010693117130

**IMBALLO / PACKING**

Pz. Pc.	Tipo Type	Larghezza Width	Profondità Depth	Altezza Height
1	cartone/carton	569	299	865
1	cartone/carton	569	401	865
1	cartone/carton	569	401	865

Tutte le misure sono espresse in millimetri / All measures are in millimeters

# Linea **CONCERT**

L'anta non è sormontata dalla parte superiore del mobile per garantirne una perfetta apertura

*The eventual weight on the highest tablet of the cabinet doesn't stop the door's opening*

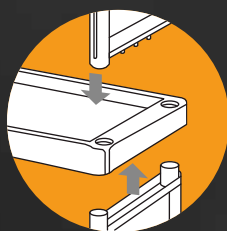

## **SISTEMA I.S.S.**

Nuovo sistema di ripiani integrati in grado di sopportare alti carichi e che garantisce massima stabilità alla struttura

### **I.S.S. SYSTEM**

*New system of integrated shelves, that gives the cabinet an high bearing capacity and stability to the structure*

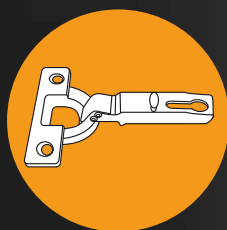

Cerniera in acciaio anti-usura per una chiusura a scatto da "vero armadio"

*Steel hinges that do not wear out quickly and that guarantee a deadlatch of the doors like a real cabinet*

Piedini che permettono la pulizia del pavimento

*Feet for the cleaning of the floor below*



# > Linea **CONCERT**

Prodotto italiano ecosostenibile  
Eco-sustainable italian product



HOME

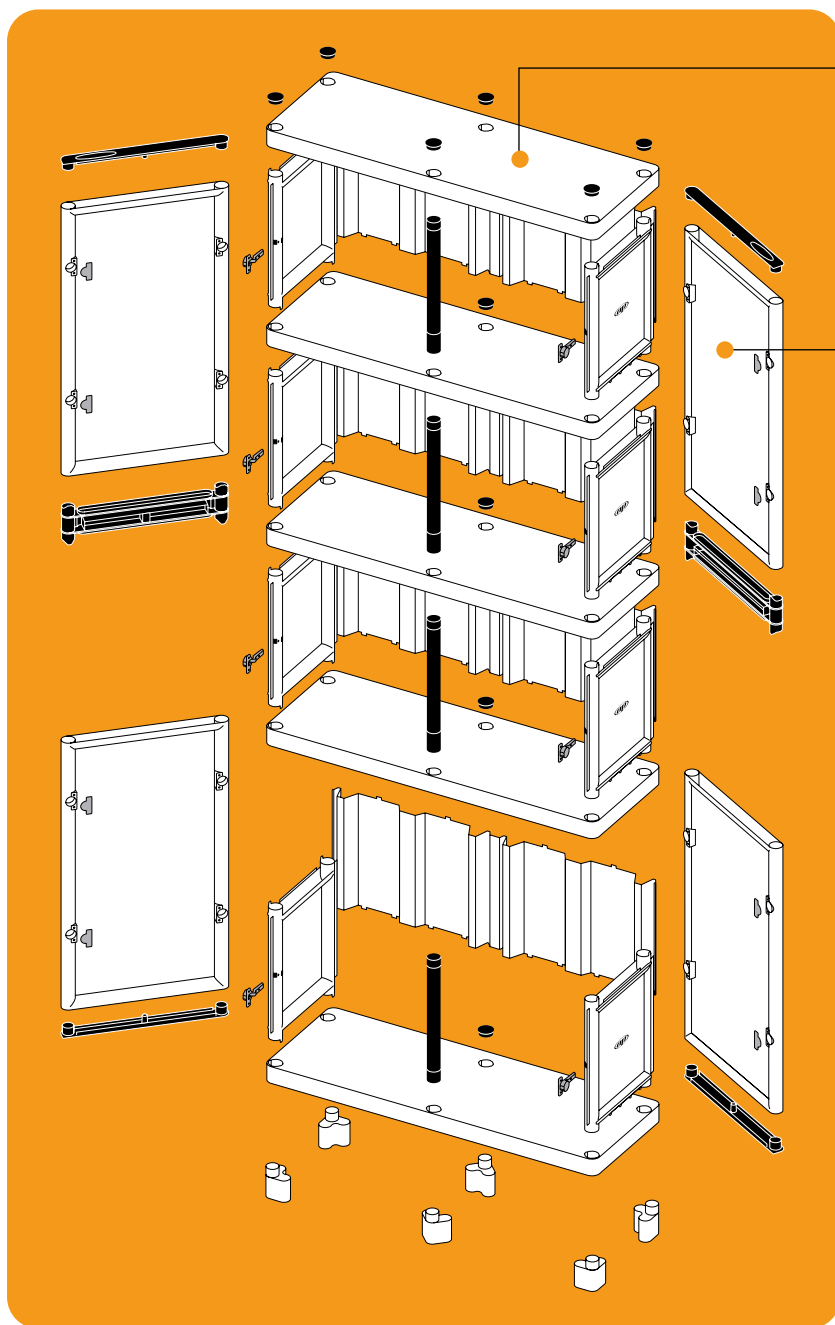

Modularità: completa componibilità di tutti gli articoli della gamma

*Modularity of all the cabinets of this range*

Costruzione a strati, ripiani integrati nella struttura e pareti portanti. Migliore stabilità, maggiore consistenza e portata dei ripiani

*Layer construction, shelves are integrated with the structure, giving much more stability, and load bearing capacity*

L'intera linea è formata da 14 modelli, divisi in quattro larghezze e differenti versioni, dall'armadio tuttopiani, all'armadio sporco/pulito. I ripiani interni hanno stabilità e portata uniche nel loro genere, grazie all'esclusivo sistema di ripiani integrati di Art Plast

*The line is composed of 14 references with 4 different length and different versions from the shelf cabinet to the clean and dirty locker. The shelves have a stability and a load bearing capacity unique in their kind, thanks to the unique Art Plast integrated-shelves-system*



# > Linea **CONCERT**

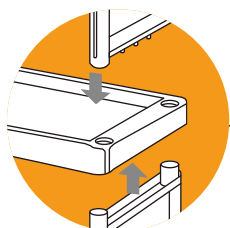

Sistema I.S.S.  
*I.S.S. System*



Lucchettabile  
*Lockable*

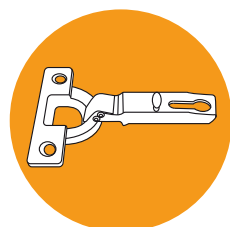

Cerniera in acciaio  
*Steel hinges*



**C50/172AP**



**C5**



**C6**

## ACCESSORI / ACCESSORIES

Descrizione Description	Codice a barre Barcode
<b>C5</b> Kit di chiusura per art. C35/C50 (Lucchetto non compreso) / Closing kit for art. C35/C50 (Padlock not included)	8010693052905
<b>C6</b> Kit di chiusura per art. C70 (Lucchetto non compreso) / Closing kit for art. C70 (Padlock not included)	8010693053001

Tutte le misure sono espresse in millimetri / All measures are in millimeters





prodotto in polipropilene  
produced in polypropylene



non assorbe gli odori  
odor-proof



non trattiene umidità  
doesn't retain humidity



semplice sistema di assemblaggio  
easy assembly system

Prodotto italiano ecosostenibile  
Eco-sustainable italian product



LARGHEZZA  
WIDTH

35 cm

LARGHEZZA  
WIDTH

50 cm



**C35/172PS**

**C35/172**

**C35/092**

**C50/172PS**

**C50/172**

**C50/092**

ARTICOLO / ARTICLE

	Larghezza Width	Profondità Depth	Altezza Height	Codice a barre Barcode
<b>C35/092</b>	350	390	920	8010693040209
<b>C35/172</b>	350	390	1720	8010693040605
<b>C35/172PS</b>	350	390	1720	8010693040704
<b>C50/092</b>	500	390	920	8010693041602
<b>C50/172</b>	500	390	1720	8010693041701
<b>C50/172AP</b>	500	390	1720	8010693042302
<b>C50/172PS</b>	500	390	1720	8010693041800

IMBALLO / PACKING

Pz. Pc.	Tipo Type	Larghezza Width	Profondità Depth	Altezza Height
1	cartone/carton	805	360	230
1	cartone/carton	805	360	395
1	cartone/carton	805	360	395
1	cartone/carton	805	200	510
1	cartone/carton	805	505	370
1	cartone/carton	805	505	370
1	cartone/carton	805	505	370

Tutte le misure sono espresse in millimetri / All measures are in millimeters

# > Linea **CONCERT**



**C70/172PS**



**C70/172**



**C70/5**



**C70/092**

LARGHEZZA  
WIDTH

70 cm

## ARTICOLO / ARTICLE

	Larghezza Width	Profondità Depth	Altezza Height	Codice a barre Barcode
<b>C70/092</b>	700	390	920	8010693039005
<b>C70/172</b>	700	390	1720	8010693039104
<b>C70/172PS</b>	700	390	1720	8010693039203
<b>C70/5</b>	700	350	1720	8010693039302

## IMBALLO / PACKING

Pz. Pc.	Tipo Type	Larghezza Width	Profondità Depth	Altezza Height
1	cartone/carton	805	365	360
1	cartone/carton	805	365	625
1	cartone/carton	805	365	625
1	cartone/carton	710	360	275

Tutte le misure sono espresse in millimetri / All measures are in millimeters



prodotto in polipropilene  
produced in polypropylene



non assorbe gli odori  
odor-proof



non trattiene umidità  
doesn't retain humidity



semplice sistema di assemblaggio  
easy assembly system

Prodotto italiano ecosostenibile  
Eco-sustainable italian product



**C100/172PS**



**C100/172**



**C100/092**

LARGHEZZA  
WIDTH

100 cm

ARTICOLO / ARTICLE

IMBALLO / PACKING

	Larghezza Width	Profondità Depth	Altezza Height	Codice a barre Barcode
<b>C100/092</b>	1000	390	920	8010693042609
<b>C100/172</b>	1000	390	1720	8010693042708
<b>C100/172PS</b>	1000	390	1720	8010693053902

Pz. Pc.	Tipo Type	Larghezza Width	Profondità Depth	Altezza Height
1	cartone/carton	1015	280	505
1	cartone/carton	1010	375	605
1	cartone/carton	1010	375	605

Tutte le misure sono espresse in millimetri / All measures are in millimeters

# Linea **CUBE**

I bauli Cube sono compatti, robusti e capienti. Adatti per la casa, garage, giardino, sottoscala, balconi, quindi sia per l'interno, sia per l'esterno. La forma "antigoccia" evita il ristagno dell'acqua, le pendenze ne favoriscono il deflusso verso l'esterno del baule.

*The Cube trunks are compact, solid and capacious. They are suitable in houses, garages, gardens, stairs, balconies, inside and outside the house. Dripping-off system, the inclinations of the components facilitate the rain fall out of the structure.*



**Lucchettabile**  
*Lockable*



Immagine su due lati,  
packaging ingegnerizzato  
per contenere al minimo  
il volume del prodotto e i  
costi di trasporto

*Dual-front illustration,  
engineered packing to limit  
the volume of the products  
and then the freight costs*



# > Linea **CUBE**

Prodotto italiano ecosostenibile  
Eco-sustainable italian product



prodotto in polipropilene  
produced in polypropylene



non assorbe gli odori  
odor-proof



non trattiene umidità  
doesn't retain humidity



semplice sistema di assemblaggio  
easy assembly system

**CB3/N**

**330 LITRI**  
Litres



**CB2/N**

**230 LITRI**  
Litres



**CB1/N**

**130 LITRI**  
Litres



**CB3/T**

**330 LITRI**  
Litres



**CB2/T**

**230 LITRI**  
Litres



**CB1/T**

**130 LITRI**  
Litres



## ARTICOLO / ARTICLE

	Larghezza Width	Profondità Depth	Altezza Height	Codice a barre Barcode
<b>CB1/N</b>	540	530	570	8010693100293
<b>CB2/N</b>	960	530	570	8010693100316
<b>CB3/N</b>	1380	530	570	8010693115877
<b>CB1/T</b>	540	530	570	8010693117024
<b>CB2/T</b>	960	530	570	8010693117031
<b>CB3/T</b>	1380	530	570	8010693117048

## IMBALLO / PACKING

Pz. Pc.	Tipo Type	Larghezza Width	Profondità Depth	Altezza Height
1	cartone/carton	540	260	545
1	cartone/carton	540	390	545
1	cartone/carton	1035	260	545
1	cartone/carton	540	260	545
1	cartone/carton	540	390	545
1	cartone/carton	1035	260	545

Tutte le misure sono espresse in millimetri / All measures are in millimeters

# Linea **RATTAN**

La linea Rattan è composta da scarpriere e box portatutto che diventano complemento d'arredo di tendenza. Sono moduli incastrabili verticalmente, predisposti anche per il fissaggio laterale e a parete.

*Rattan line consists of shoeracks and boxes that become high design furniture accessories. They are vertically linkable, ready to be fixed on the wall or sideways.*

Effetto trama intrecciata  
*Textured woven effect*

Spessore contenuto  
*Reduced thickness*

Struttura modulare  
agganciabile e componibile  
*Modular and  
linkable structure*

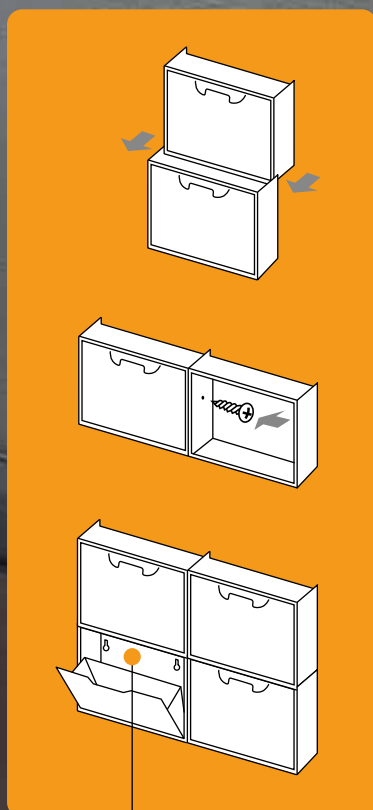

# > Linea **RATTAN**

Prodotto italiano ecosostenibile  
Eco-sustainable italian product



prodotto in polipropilene  
produced in polypropylene



non assorbe gli odori  
odor-proof



non trattiene umidità  
doesn't retain humidity



semplice sistema di assemblaggio  
easy assembly system

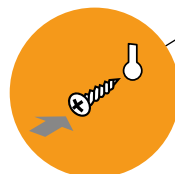
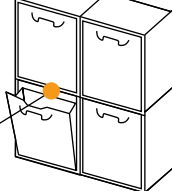
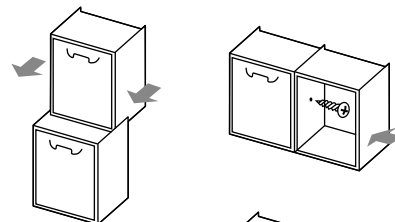

**CASSETTO PORTATUTTO**  
*Storage line*

## **LINEA SCARPIERE** *Shoe Racks Line*

**U50/FRT**



**U50/FRW**

**R34/1FRW**

**R34/1FRT**

### ARTICOLO / ARTICLE

	Larghezza Width	Profondità Depth	Altezza Height	Codice a barre Barcode
<b>U50/FRW</b>	510	173	401	8010693104970
<b>U50/FRT</b>	510	173	401	8010693117963
<b>R34/1FRW</b>	340	290	470	8010693101498
<b>R34/1FRT</b>	340	290	470	8010693118199

### IMBALLO / PACKING

Pz. Pc.	Tipo Type	Larghezza Width	Profondità Depth	Altezza Height
4	cartone/carton	1035	350	420
4	cartone/carton	1035	350	420
3	cartone/carton	485	295	1035
3	cartone/carton	485	295	1035

Tutte le misure sono espresse in millimetri / All measures are in millimeters

# Linea **UNIKA**

Unika è una scarpiera agganciabile e componibile, incastrabile verticalmente, predisposta anche per il fissaggio laterale e a parete. Ha uno spessore molto contenuto che ne permette il posizionamento anche dietro alle porte. Robusta e capiente, dal design gradevole e lineare, può contenere scarpe e stivali, anche di misure particolarmente grandi.

*Unika is a modular shoe racks. Units are stackable and ready to be fixed on the wall or sideways. Thanks to its contained thickness, it can be placed also behind the doors. It's very solid and capacious with a pleasant and linear design and it can contain every kind of shoes or boots, also if they have a big size.*

Spessore contenuto  
*Reduced thickness*

Struttura modulare  
agganciabile e componibile  
*Modular and  
linkable structure*

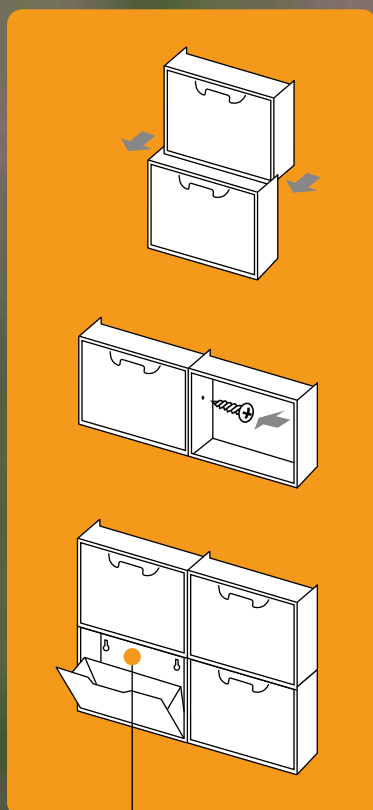



# > Linea **UNIKA**

Prodotto italiano ecosostenibile  
Eco-sustainable italian product



prodotto in polipropilene  
produced in polypropylene



non assorbe gli odori  
odor-proof



non trattiene umidità  
doesn't retain humidity



semplice sistema di assemblaggio  
easy assembly system

Ogni sportello può contenere fino a 3 paia di scarpe

*Each rack can contain up to 3 pair of shoes*

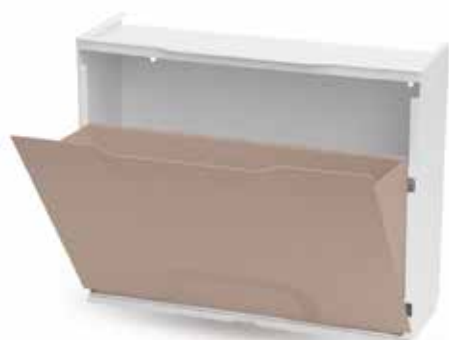

**U50RA**

Rosa Antico  
*Ancient rose*

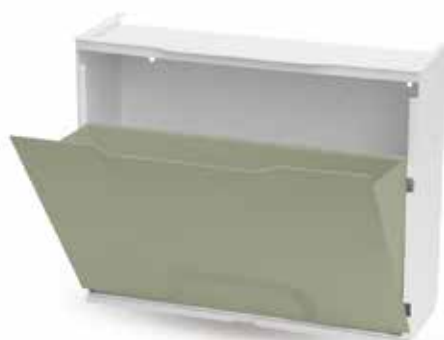

**U50VO**

Verde Oliva  
*Olive green*



**U50BN**

Blu Navy  
*Blue navy*



**U50W**



**U50TO**



**U50N**

## ARTICOLO / ARTICLE

	Larghezza Width	Profondità Depth	Altezza Height	Colore Color	Codice a barre Barcode
<b>U50RA</b>	510	173	401		8010693126743
<b>U50VO</b>	510	173	401		8010693126750
<b>U50BN</b>	510	173	401		8010693126767
<b>U50W</b>	510	173	401		8010693100255
<b>U50TO</b>	510	173	401		8010693117987
<b>U50N</b>	510	173	401		8010693100262

## IMBALLO / PACKING

Pz. Pc.	Tipo Type	Larghezza Width	Profondità Depth	Altezza Height
7	cartone/carton	1035	350	420
7	cartone/carton	1035	350	420
7	cartone/carton	1035	350	420
7	cartone/carton	1035	350	420
7	cartone/carton	1035	350	420
7	cartone/carton	1035	350	420

Tutte le misure sono espresse in millimetri / All measures are in millimeters

NEW! NEW! NEW!  
NEW! NEW! NEW!  
NEW! NEW! NEW!

## Linea **FLIP FLAP**

I porta scarpe Flip Flap sono un modo semplice e veloce per sfruttare al meglio lo spazio a disposizione verticalmente, inoltre gli agganci laterali possono essere uniti tra loro rimanendo allineati al loro posto.

*The Flip Flap shoe racks are a quick and easy way to make the most of the space available vertically, also the side hooks can be joined together while remaining aligned in their place.*



# > Linea **FLIP FLAP**

Prodotto italiano ecosostenibile  
Eco-sustainable italian product



prodotto in polipropilene  
produced in polypropylene



non assorbe gli odori  
odor-proof



non trattiene umidità  
doesn't retain humidity



semplice sistema di assemblaggio  
easy assembly system

## U22W/KIT

**KIT 3 PEZZI**  
*Kit 3 pieces*



## U22AN/KIT

**KIT 3 PEZZI**  
*Kit 3 pieces*

COLORI/colors:



### ARTICOLO / ARTICLE

	Larghezza Width	Profondità Depth	Altezza Height	Colore Color	Codice a barre Barcode
<b>U22W/KIT</b>	150	225	185		8010693124138
<b>U22E/KIT</b>	150	225	185		8010693124145
<b>U22TO/KIT</b>	150	225	185		8010693124152
<b>U22AN/KIT</b>	150	225	185		8010693124169
<b>U22TR/KIT</b>	150	225	185		8010693124176

### IMBALLO / PACKING

Pz. Pc.	Tipo Type	Larghezza Width	Profondità Depth	Altezza Height
8	cartone/carton	390	170	500
8	cartone/carton	390	170	500
8	cartone/carton	390	170	500
8	cartone/carton	390	170	500
8	cartone/carton	390	170	500

Tutte le misure sono espresse in millimetri / All measures are in millimeters

NEW! NEW! NEW! NEW! NEW!

## Linea **ENJOY**

**Si possono realizzare svariate composizioni in orizzontale e in verticale.**

***Various compositions can be made horizontally and vertically.***



# > Linea **ENJOY**

Prodotto italiano ecosostenibile  
Eco-sustainable italian product



prodotto in  
nylon fibra di  
vetro  
produced in  
nylon glass  
fibre



non assorbe  
gli odori  
odor-proof



non trattiene  
umidità  
doesn't retain  
humidity



semplice sistema  
di assemblaggio  
easy assembly  
system



**MOR090**



**MOR180**

**MORSETTO DISPONIBILE IN DIVERSI COLORI  
CON MINIMO D'ORDINE DA CONCORDARE**

*Clamp available in different colors with a minimum order to be agreed*

# > Linea **ENJOY**

## MOR180

**IN OGNI CONFEZIONE:**

*In every package:*

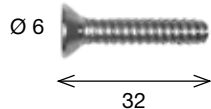

16X



8X



8X



8X



31

62

26

### SPESSORE PANNELLO

*Panel thickness da 4 a 8 mm*

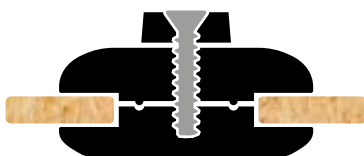

### SPESSORE PANNELLO

*Panel thickness da 9 a 12 mm*



## MOR090

**IN OGNI CONFEZIONE:**

*In every package:*

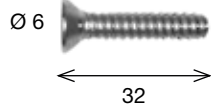

16X



8X



8X



8X



31

71

34

### SPESSORE PANNELLO

*Panel thickness da 4 a 8 mm*



### SPESSORE PANNELLO

*Panel thickness da 9 a 12 mm*



### ARTICOLO / ARTICLE

	Larghezza Width	Profondità Depth	Altezza Height	Codice a barre Barcode
<b>MOR180</b>	155	55	300	8010693125302
<b>MOR090</b>	155	55	300	8010693125296

### IMBALLO / PACKING

Pz. Pc.	Tipo Type	Larghezza Width	Profondità Depth	Altezza Height
12	scatola/box	245	245	335
12	scatola/box	245	245	335

Tutte le misure sono espresse in millimetri / All measures are in millimeters

# > Linea ENJOY

## ARTICOLO / ARTICLE

## IMBALLO / PACKING

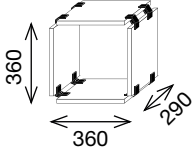
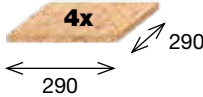
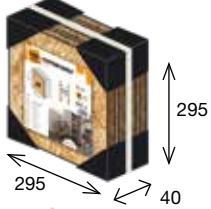
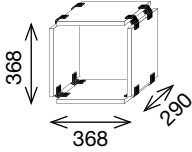
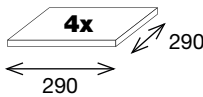
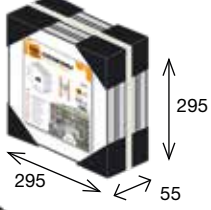
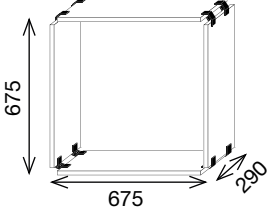
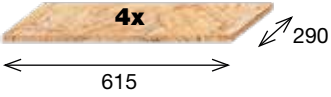
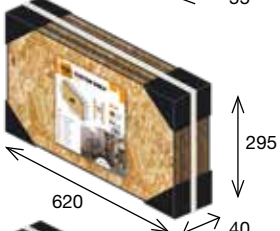
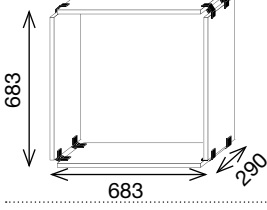
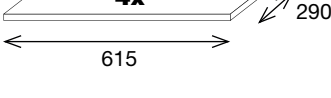
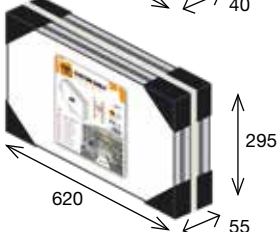
Struttura Structure	Pannello / Colore Panel / Color	Codice prodotto Product code	Codice a barre Barcode	Tipo imballo Packing type	Struttura Structure
	Spessore / Thickness 8 	<b>PANOSB29</b>	8010693125319	scatola carton box	
	Spessore / Thickness 12 	<b>PANLAM29</b>	8010693125326	scatola carton box	
	Spessore / Thickness 8 	<b>PANOSB62</b>	8010693125333	scatola carton box	
	Spessore / Thickness 12 	<b>PANLAM62</b>	8010693125340	scatola carton box	



## Linea **BAGNO**

Pratico tappeto in gomma antiscivolo e antimuffa, realizzato con materiale ecosostenibile che non assorbe gli odori. Offre grande sicurezza grazie alle molteplici ventose distribuite su tutta la superficie sottostante. Durevole, lavabile in lavatrice, resistente all'abrasione e facile da pulire.

*Practical non-slip and anti-mold rubber mat, made with eco-sustainable material that does not absorb odors. It offers great security thanks to the multiple suction cups distributed over the entire surface below. Durable, machine washable, abrasion resistant and easy to clean.*



# > Linea **BAGNO**

Prodotto italiano ecosostenibile  
Eco-sustainable italian product



senza PVC  
PVC free



non assorbe  
gli odori  
odor-proof



non trattiene  
umidità  
doesn't retain  
humidity



semplice sistema  
di assemblaggio  
easy assembly  
system



**TDQ5454TO**



## DETTAGLIO EFFETTO VENTOSA

*Suction cups effect detail*

Il retro del tappeto è realizzato con un sistema di ventose che garantiscono perfette aderenza e stabilità.

*The back of the mat is made with an innovative system of suction cups that allows it to have a perfect adherence and stability.*

## DISPONIBILE IN DUE FORMATI

*Two sizes available*



## DISPONIBILE IN DUE COLORI

*Two colors available*



**NUOVO MATERIALE  
ECOSOSTENIBILE  
NEW SUSTAINABLE  
MATERIAL  
NO PVC**

### ARTICOLO / ARTICLE

	Larghezza Width	Profondità Depth	Altezza Height	Colore Color	Codice a barre Barcode
<b>TDQ5454W</b>	545	535	4		8010693123070
<b>TDQ5454TO</b>	545	535	4		8010693123063

### IMBALLO / PACKING

Pz. Pc.	Tipo Type	Larghezza Width	Profondità Depth	Altezza Height
12	scatola/carton box	400	350	250
12	scatola/carton box	400	350	250

Tutte le misure sono espresse in millimetri / All measures are in millimeters

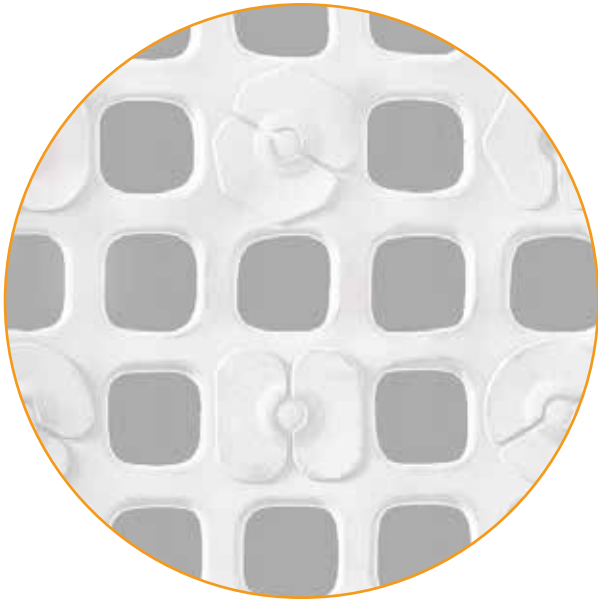

Texture antiscivolo dal design ispirato alle cementine.  
*Non-slip texture in cementine inspired design.*

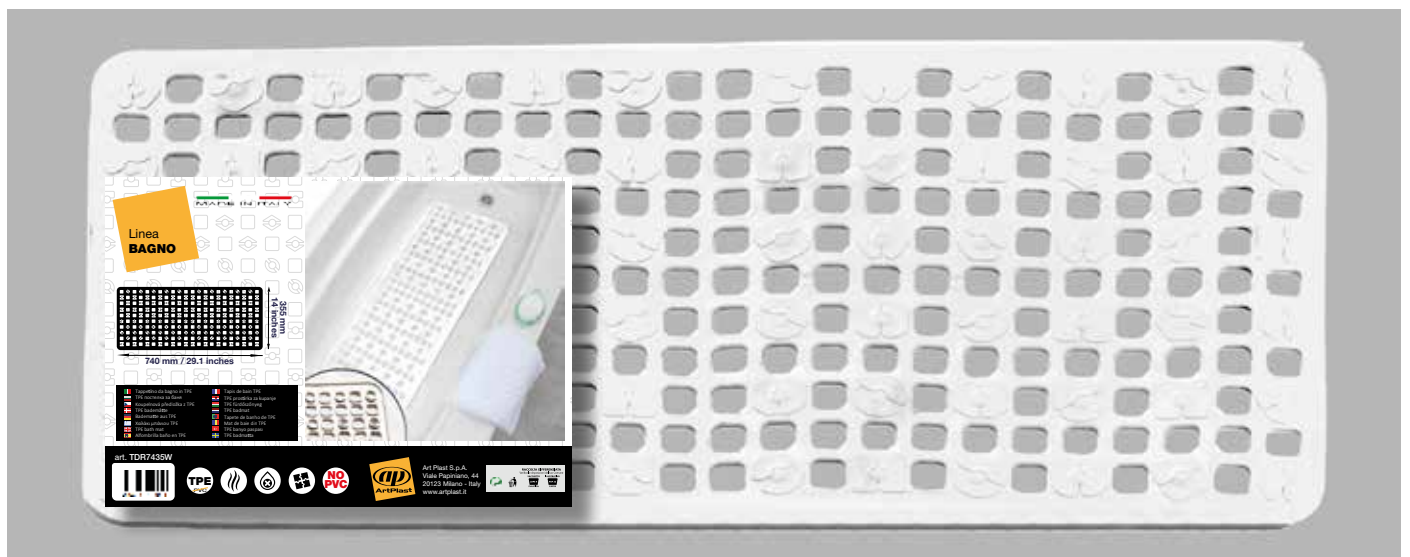

**TDR7435W**



**ARTICOLO / ARTICLE**

**IMBALLO / PACKING**

	Larghezza Width	Profondità Depth	Altezza Height	Colore Color	Codice a barre Barcode
<b>TDR7435W</b>	740	355	4		8010693123094
<b>TDR7435TO</b>	740	355	4		8010693123087

Pz. Pc.	Tipo Type	Larghezza Width	Profondità Depth	Altezza Height
8	scatola/carton box	532	432	189
8	scatola/carton box	539	432	189

Tutte le misure sono espresse in millimetri / All measures are in millimeters

# > Linea **BAGNO**

Prodotto italiano ecosostenibile  
Eco-sustainable italian product



prodotto in polipropilene  
produced in polypropylene



non assorbe gli odori  
odor-proof



non trattiene umidità  
doesn't retain humidity



semplice sistema di assemblaggio  
easy assembly system

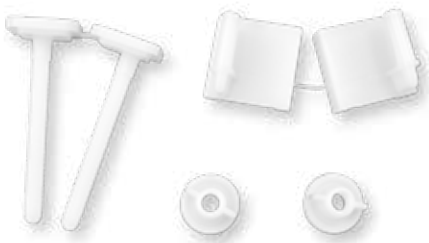
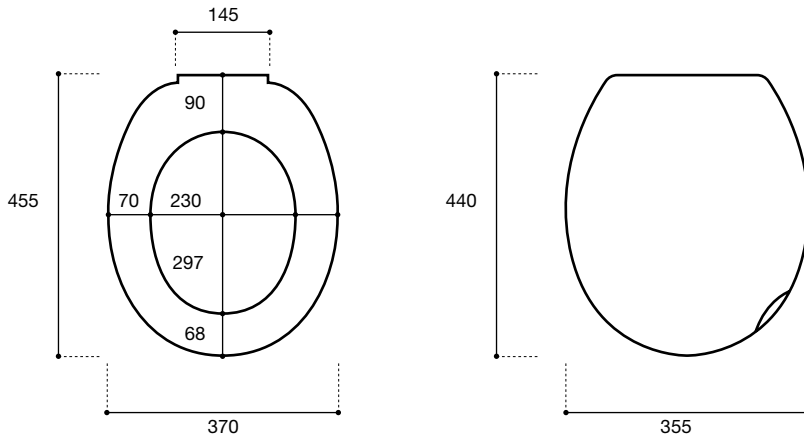

attacchi  
fastening

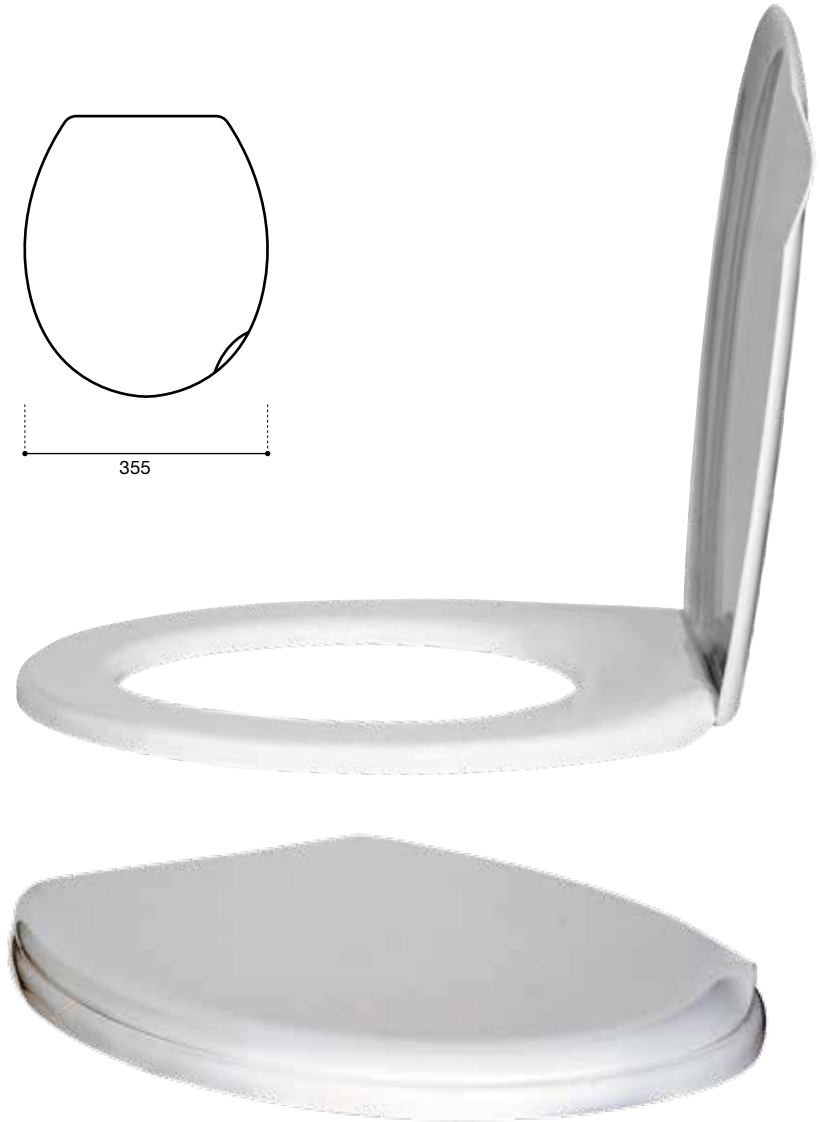

**TAV46W**

## ARTICOLO / ARTICLE

Larghezza Width	Profondità Depth	Altezza Height	Colore Color	Codice a barre Barcode
460	375	50		8010693123841

**TAV46W**

## IMBALLO / PACKING

Pz. Pc.	Tipo Type	Larghezza Width	Profondità Depth	Altezza Height
10	scatola/carton box	490	370	370

Tutte le misure sono espresse in millimetri / All measures are in millimeters

## Linea **TUOBOX**

I contenitori milleusi della linea Tuobox sono pratici, capienti e sovrapponibili, usati per sistemare gli oggetti più vari, dai giochi all'abbigliamento. Utilissimi in casa, cantina, sottoscala, balcone, garage e giardino. Disponibili con maniglie e rotelle che ne facilitano l'utilizzo "sottoletto".

*Tuobox line containers are practical, capacious and super imposable. They are used to arrange many objects, from the toys to the clothes. They are very useful for houses, garages, gardens, basement, balconies, etc. They are also available with hooks and with small wheels that make easier their use "underbed".*



# > Linea **TUOBOX**

Prodotto italiano ecosostenibile  
Eco-sustainable italian product



prodotto in polipropilene  
produced in polypropylene



non assorbe gli odori  
odor-proof



non trattiene umidità  
doesn't retain humidity

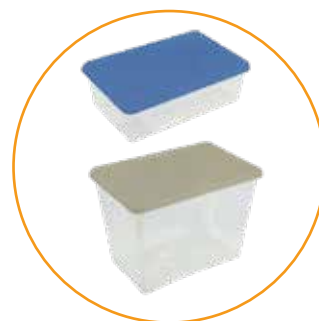

È possibile avere coperchi colorati su richiesta

*On request it is possible to have colored lids*

**ML40TT**

**29** LITRI  
Litres



**ML70TT**

**43** LITRI  
Litres



**ML90TT**

**60** LITRI  
Litres



## ARTICOLO / ARTICLE

	Larghezza Width	Profondità Depth	Altezza Height	Codice a barre Barcode
<b>ML40TT</b>	585	390	170	8010693119868
<b>ML70TT</b>	585	390	300	8010693119875
<b>ML90TT</b>	585	390	410	8010693119882

## IMBALLO / PACKING

Pz. Pc.	Tipo Type	Larghezza Width	Profondità Depth	Altezza Height
12	cartone/carton	597	395	475
7	cartone/carton	597	395	475
11	cartone/carton	570	400	695

Tutte le misure sono espresse in millimetri / All measures are in millimeters

# Linea **TUOBOX**

Bordo resistente e chiusura  
semplice e veloce

*Strong edge and simple  
and fast closure*



È possibile avere le  
maniglie colorate su  
richiesta  
On request it is  
possible to have  
colored handles



# > Linea **TUOBOX**

Prodotto italiano ecosostenibile  
Eco-sustainable italian product



prodotto in polipropilene  
produced in polypropylene



non assorbe gli odori  
odor-proof



non trattiene umidità  
doesn't retain humidity

Su richiesta è possibile avere i coperchi colorati

*On request it is possible to have colored lids*



**MP40TTV**

**29** LITRI

Litres



**MP70TTV**

**43** LITRI

Litres



**MP90TTV**

**60** LITRI

Litres



## ARTICOLO / ARTICLE

	Larghezza Width	Profondità Depth	Altezza Height	Codice a barre Barcode
<b>MP40TTV</b>	585	390	170	8010693119899
<b>MP70TTV</b>	585	390	300	8010693119905
<b>MP90TTV</b>	585	390	410	8010693119912

## IMBALLO / PACKING

Pz. Pc.	Tipo Type	Larghezza Width	Profondità Depth	Altezza Height
12	cartone/carton	597	395	475
7	cartone/carton	597	395	475
11	cartone/carton	570	400	695

Tutte le misure sono espresse in millimetri / All measures are in millimeters

## Linea **MIOBOX**

I contenitori milleusi della linea Miobox sono pratici, capienti e sovrapponibili, usati per sistemare gli oggetti più vari, dai giochi all'abbigliamento. Utilissimi in casa, cantina, sottoscala, balcone, garage e giardino. Disponibili sia completamente trasparenti, sia con fondo trasparente e coperchio colorato che nella versione "sottoletto" con rotelline che ne facilitano l'utilizzo.

*Miobox line containers are practical, capacious and super imposable. They are used to arrange many objects, from the toys to the clothes. They are very useful for houses, garages, gardens, basement, balconies, etc. They are available both completely transparent and with a transparent bottom and colored covers. They are also available in the "underbed" version, with small wheels that make easier their use.*

Lo spessore del prodotto  
ne garantisce la robustezza  
*The thickness of the product  
guarantees its strenght*





# > Linea **MIOBOX**

Prodotto italiano ecosostenibile  
Eco-sustainable italian product



prodotto in polipropilene  
produced in polypropylene



non assorbe gli odori  
odor-proof



non trattiene umidità  
doesn't retain humidity

**20 LITRI**  
Litres 



**M31TT**



**M31BT**



**M31AT**



**M41TT**

**26 LITRI**  
Litres 









**M41AT**



**M41BT**

## ARTICOLO / ARTICLE

## IMBALLO / PACKING

	Larghezza Width	Profondità Depth	Altezza Height	Colore Color	Codice a barre Barcode	Pz. Pc.	Tipo Type	Larghezza Width	Profondità Depth	Altezza Height
<b>M31TT</b>	390	290	272		8010693065004	10	cartone/carton	383	320	710
<b>M31BT</b>	390	290	272		8010693065103	10	cartone/carton	383	320	710
<b>M31AT</b>	390	290	272		8010693065301	10	cartone/carton	383	320	710
<b>M41TT</b>	565	390	180		8010693065509	10	cartone/carton	570	400	695
<b>M41BT</b>	565	390	180		8010693065608	10	cartone/carton	570	400	695
<b>M41AT</b>	565	390	180		8010693065806	10	cartone/carton	570	400	695

Tutte le misure sono espresse in millimetri / All measures are in millimeters

# > Linea **MIOBOX**



**M76TT**





**M76BT**

**51 LITRI**  
Litres 



**M76AT**

## ARTICOLO / ARTICLE

	Larghezza Width	Profondità Depth	Altezza Height	Colore Color	Codice a barre Barcode
<b>M76TT</b>	565	390	350		8010693066001
<b>M76BT</b>	565	390	350		8010693066100
<b>M76AT</b>	565	390	350		8010693066308

## IMBALLO / PACKING

Pz. Pc.	Tipo Type	Larghezza Width	Profondità Depth	Altezza Height
10	cartone/carton	573	402	890
10	cartone/carton	573	402	890
10	cartone/carton	573	402	890

Tutte le misure sono espresse in millimetri / All measures are in millimeters



prodotto in polipropilene  
produced in polypropylene



non assorbe gli odori  
odor-proof



non trattiene umidità  
doesn't retain humidity

Prodotto italiano ecosostenibile  
Eco-sustainable italian product



**M86TT**

**60 LITRI**  
Litres



**M86BT**



**M86AT**

**ARTICOLO / ARTICLE**

**IMBALLO / PACKING**

	Larghezza Width	Profondità Depth	Altezza Height	Colore Color	Codice a barre Barcode
<b>M86TT</b>	795	590	180		8010693067800
<b>M86BT</b>	795	590	180		8010693067701
<b>M86AT</b>	795	590	180		8010693067602

Pz. Pc.	Tipo Type	Larghezza Width	Profondità Depth	Altezza Height
4	cartone/carton	580	320	800
4	cartone/carton	580	320	800
4	cartone/carton	580	320	800

Tutte le misure sono espresse in millimetri / All measures are in millimeters

# Linea **EUROBOX**

I contenitori della linea Eurobox sono resistenti, impilabili, facili da pulire e modulari. Perfetti in cucina per contenere utensili e alimenti.

*The containers of the Eurobox line are resistant, stackable, easy to clean and modular. Perfect in the kitchen to hold utensils and food.*

**EUROBOX**  
MODULAR SYSTEM



**MODULARITÀ:  
TUTTI I CONTENITORI SONO  
IMPILABILI PER RISPARMIARE  
SPAZIO**

*Modularity: all the boxes are stackable to save space*



# > Linea **EUROBOX**

Prodotto italiano ecosostenibile  
Eco-sustainable italian product



prodotto in polipropilene  
produced in polypropylene



non assorbe gli odori  
odor-proof



non trattiene umidità  
doesn't retain humidity



per uso alimentare  
for food use

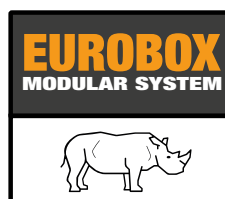

**EN604012T**

**24** LITRI  
Litres



**EN604022T**

**44** LITRI  
Litres



**EN604032T**

**65** LITRI  
Litres



## ARTICOLO / ARTICLE

	Larghezza Width	Profondità Depth	Altezza Height	Codice a barre Barcode
<b>EN604012T</b>	600	400	120	8010693119806
<b>EN604022T</b>	600	400	220	8010693119813
<b>EN604032T</b>	600	400	320	8010693119820

## IMBALLO / PACKING

Pz. Pc.	Tipo Type	Larghezza Width	Profondità Depth	Altezza Height
1	sfuso/bulk	600	400	120
1	sfuso/bulk	600	400	220
1	sfuso/bulk	600	400	320

Tutte le misure sono espresse in millimetri / All measures are in millimeters

# > Linea **EUROBOX**



prodotto in polipropilene  
produced in polypropylene



non assorbe gli odori  
odor-proof



non trattiene umidità  
doesn't retain humidity



per uso alimentare  
for food use

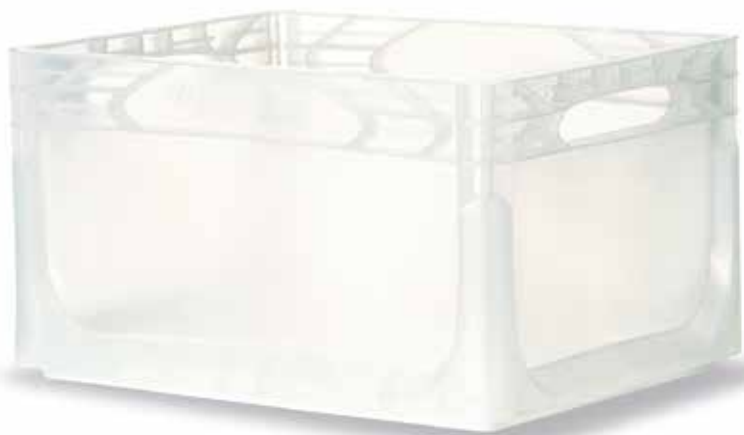
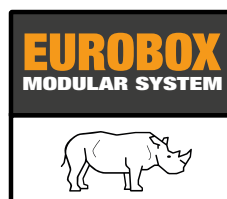

**EN403022T**

**20** LITRI  
Litres



**EN302017T**

**7** LITRI  
Litres



**EN302012T**

**5** LITRI  
Litres



**EN201517T**

**3** LITRI  
Litres



## ARTICOLO / ARTICLE

	Larghezza Width	Profondità Depth	Altezza Height	Codice a barre Barcode
<b>EN403022T</b>	400	300	220	8010693120963
<b>EN302017T</b>	300	200	170	8010693121304
<b>EN302012T</b>	300	200	120	8010693121298
<b>EN201517T</b>	200	150	170	8010693121335

## IMBALLO / PACKING

Pz. Pc.	Tipo Type	Larghezza Width	Profondità Depth	Altezza Height
1	sfuso/bulk	400	300	220
1	sfuso/bulk	300	200	170
1	sfuso/bulk	300	200	120
1	sfuso/bulk	200	150	170

Tutte le misure sono espresse in millimetri / All measures are in millimeters



Prodotto italiano ecosostenibile  
Eco-sustainable italian product



## OGNI CONTENITORE PUÒ ESSERE RICHIUDIBILE CON COPERCHIO

*Each container can be closed with a lid*



Coperchio con cerniere e chiusure realizzate in materiale tecnopolimero POM

*Lid with hinges and closures made of POM technopolymer material*



**ENC4030CT**



**ENC6040CT**



**ENC6040ST**



**ENC4030ST**



**ENC3020ST**



**ENC2015ST**

### ARTICOLO / ARTICLE

### IMBALLO / PACKING

	Larghezza Width	Profondità Depth	Altezza Height	Codice a barre Barcode
<b>ENC6040ST</b>	600	400	23	8010693121083
<b>ENC6040CT</b>	600	400	23	8010693121090
<b>ENC4030ST</b>	400	300	23	8010693121045
<b>ENC4030CT</b>	400	300	23	8010693121052
<b>ENC3020ST</b>	300	200	23	8010693121342
<b>ENC2015ST</b>	200	150	23	8010693121359

Pz. Pc.	Tipo Type	Larghezza Width	Profondità Depth	Altezza Height
10	film termoretrato/ shrinked film	600	400	150
10	film termoretrato/ shrinked film	600	400	150
10	film termoretrato/ shrinked film	400	300	150
10	film termoretrato/ shrinked film	400	300	150
10	film termoretrato/ shrinked film	300	200	150
10	film termoretrato/ shrinked film	200	150	150

Tutte le misure sono espresse in millimetri / All measures are in millimeters

## Linea **PELLETBOX**

Contenitore in polipropilene ad uso esterno ed interno per il pellet con una capacità fino a 20 kg, inoltre una pratica chiusura permette allo stesso di non perdere il contenuto qualora dovesse ribaltarsi.

*Polypropylene container for outdoor and indoor use for pellets with a capacity of up to 20 kg, also a practical closure allows the same not to lose the content should it overturn.*





# > Linea **PELLETBOX**

Prodotto italiano ecosostenibile  
Eco-sustainable italian product



prodotto in polipropilene  
produced in polypropylene



non assorbe gli odori  
odor-proof



non trattiene umidità  
doesn't retain humidity



semplice sistema di assemblaggio  
easy assembly system



Capacità maggiore di un sacco di pellet, circa 20 Kg

*Greater capacity than 20 Kg pellet bag.*



Sistema di chiusura antiribaltamento

*Anti-tipping closure system*



**BP35/E**

**39** LITRI

Litres



## ARTICOLO / ARTICLE

Larghezza Width	Profondità Depth	Altezza Height	Codice a barre Barcode
<b>BP35/E</b> 400	305	510	8010693121120

## IMBALLO / PACKING

Pz. Pc.	Tipo Type	Larghezza Width	Profondità Depth	Altezza Height
6	cartone/carton	383	396	760

Tutte le misure sono espresse in millimetri / All measures are in millimeters

## Linea **DOLLY**

La struttura di questo carrellino è formata da una solida piattaforma per sostenere o spostare oggetti, mentre le ruote girevoli consentono di muoverlo in tutte le direzioni. L'articolo viene prodotto in polipropilene con una superficie che permette anche di agganciarlo sui quattro lati con carrelli analoghi per aumentare la superficie.

*The structure of this trolley is formed by a solid platform to support or move objects, while the swivel wheels allow you to move it in all directions. The article is produced in polypropylene with a surface that also allows to hook it with the same trolleys to increase the flow area.*



# > Linea **DOLLY**

Prodotto italiano ecosostenibile  
Eco-sustainable italian product



prodotto in polipropilene  
produced in polypropylene



non assorbe gli odori  
odor-proof



non trattiene umidità  
doesn't retain humidity



semplice sistema di assemblaggio  
easy assembly system

## **COLORI PERSONALIZZATI DISPONIBILI CON MINIMO D'ORDINE DA CONCORDARE:**

*Colors available with minimum order quantity to be agreed:*



**L4829E/R35**

Foro per inserire la corda per facilitare lo spostamento

*Hole to insert the rope to facilitate movement*

Sistema di aggancio per poter ampliare la pedana su 4 lati

*Hooking system to expand the platform 4 sides*

4 Maniglie di presa  
*4 carry handles*



**L3030/E**



### ARTICOLO / ARTICLE

Larghezza Width	Profondità Depth	Altezza Height	Codice a barre Barcode
<b>L3030/E</b> 300	300	70	8010693121458
<b>L4829E/R35</b> 480	290	80	8010693119998

### IMBALLO / PACKING

Pz. Pc.	Tipo Type	Larghezza Width	Profondità Depth	Altezza Height
14	cartone/carton	300	300	530
10	cartone/carton	485	295	385

Tutte le misure sono espresse in millimetri / All measures are in millimeters

# Linea **LABELLING**

La Linea Labelling propone diversi temi, disponibili con minimo d'ordine da concordare.

*The Labelling Line offers several topics, available with minimum order to be agreed.*



# > Linea LABELLING

Prodotto italiano ecosostenibile  
Eco-sustainable italian product



prodotto in polipropilene  
produced in polypropylene



non assorbe gli odori  
odor-proof



non trattiene umidità  
doesn't retain humidity

# Italy

HOME

## SCARPIERA UNIKA

Unika shoe rack



**U50/IT**

## BAULE CUBE

Cube trunk



**CB1/RM**

**CB1/VE**

## CONTENITORI MIOBOX

Miobox containers



**M76/VE**

**M76/RM**

**M41/RM**

**M41/VE**

### ARTICOLO / ARTICLE

	Larghezza Width	Profondità Depth	Altezza Height	Codice a barre Barcode
<b>U50/IT</b>	510	173	401	8010693105267
<b>M41/RM</b>	565	390	180	8010693100033
<b>M41/VE</b>	565	390	180	8010693100026
<b>M76/RM</b>	565	390	350	8010693100057
<b>M76/VE</b>	565	390	350	8010693100040
<b>CB1/RM</b>	540	530	570	8010693100002
<b>CB1/VE</b>	540	530	570	8010693100019

### IMBALLO / PACKING

Pz. Pc.	Tipo Type	Larghezza Width	Profondità Depth	Altezza Height
4	cartone/carton	420	350	1035
10	cartone/carton	570	400	695
10	cartone/carton	570	400	695
10	cartone/carton	573	402	890
10	cartone/carton	573	402	890
1	cartone/carton	540	260	545
1	cartone/carton	540	260	545

Tutte le misure sono espresse in millimetri / All measures are in millimeters



prodotto in  
polipropilene  
produced in  
polypropylene



non assorbe  
gli odori  
odor-proof



non trattiene  
umidità  
doesn't retain  
humidity

## CONTENITORI MIOBOX

*Miobox containers*



**M41LON**



**M41NY**



**M41R66**



**M76LON**



**M76NY**



**M76R66**

## BAULE CUBE

*Cube trunk*



**CB1/LON**

**CB1/NY**



**CB1/R66**



# > Linea LABELLING

Prodotto italiano ecosostenibile  
Eco-sustainable italian product



HOME

## SCARPIERA UNIKA

Unika shoe rack



**U50/LON**

**U50/NY**

**U50/R66**

### ARTICOLO / ARTICLE

	Larghezza Width	Profondità Depth	Altezza Height	Codice a barre Barcode
<b>M41/LON</b>	565	390	180	8010693098200
<b>M41/NY</b>	565	390	180	8010693098101
<b>M41/R66</b>	565	390	180	8010693100064
<b>M76/LON</b>	565	390	350	8010693098507
<b>M76/NY</b>	565	390	350	8010693098408
<b>M76/R66</b>	565	390	350	8010693100071
<b>CB1/LON</b>	540	530	570	8010693097401
<b>CB1/NY</b>	540	530	570	8010693097302
<b>CB1/R66</b>	540	530	570	8010693100088
<b>U50/LON</b>	510	173	401	8010693105236
<b>U50/NY</b>	510	173	401	8010693105229
<b>U50/R66</b>	510	173	401	8010693105243

### IMBALLO / PACKING

Pz. Pc.	Tipo Type	Larghezza Width	Profondità Depth	Altezza Height
10	cartone/carton	570	400	695
10	cartone/carton	570	400	695
10	cartone/carton	570	400	695
10	cartone/carton	573	402	890
10	cartone/carton	573	402	890
10	cartone/carton	573	402	890
1	cartone/carton	540	260	545
1	cartone/carton	540	260	545
1	cartone/carton	540	260	545
4	cartone/carton	420	350	1035
4	cartone/carton	420	350	1035
4	cartone/carton	420	350	1035

Tutte le misure sono espresse in millimetri / All measures are in millimeters

# Linea **FLEXBAG**

La linea FLEXBAG nasce dalla necessità di rispondere ai diversi bisogni della quotidianità, dalla pesca al bucato, dal giardinaggio all'edilizia. Si tratta di un contenitore/borsa milleusi che si presta a svariati utilizzi:

- sostituto della busta di plastica
- contenitore multiuso (giocattoli, riviste, oggettistica varia)
- per l'edilizia come portattrezzi, secchiello dell'acqua, per il cemento e contenitore per il calcestruzzo
- per il giardinaggio e l'agricoltura come innaffiatoio, porta attrezzi, mastello
- per le vacanze è ideale come borsa da spiaggia o a da piscina

*This line of plastic bags is our solution to everyday needs, from fishing to laundry, gardening and construction.*

*It is a bag that can be used for many different purposes:*

- as substitute for disposable plastic bags
- multi-purpose container (toys, magazines, and various objects)
- for building (water bucket, bucket for concrete)
- for gardening (watering, tools holder, tub)
- for holidays as beach or pool bag

**Extra flessibile**  
*Extra Flexible*

**Multiuso**  
*Multipurpose*





# > Linea **FLEXBAG**

Prodotto italiano ecosostenibile  
Eco-sustainable italian product



prodotto in  
polipropilene  
produced in  
polypropylene



non assorbe  
gli odori  
odor-proof



non trattiene  
umidità  
doesn't retain  
humidity



**FB** 15 **LITRI**  
Litres

**FB1** 25 **LITRI**  
Litres

**FB2** 42 **LITRI**  
Litres



## ARTICOLO / ARTICLE

	ø	ø Inf.	Altezza	Litri	Colore	Codice a barre
	ø	ø inf.	Heigth	liter	Color	Barcode
<b>FB/A</b>	326	250	280	15		8010693069903
<b>FB/R</b>	326	250	280	15		8010693070008
<b>FB/V</b>	326	250	280	15		8010693070206
<b>FB/B</b>	326	250	280	15		8010693070305
<b>FB1/A</b>	385	280	340	25		8010693067909
<b>FB1/R</b>	385	280	340	25		8010693068005
<b>FB1/V</b>	385	280	340	25		8010693068104
<b>FB1/B</b>	385	280	340	25		8010693068203
<b>FB2/A</b>	455	360	385	42		8010693070404
<b>FB2/R</b>	455	360	385	42		8010693070503
<b>FB2/V</b>	455	360	385	42		8010693070701
<b>FB2/B</b>	455	360	385	42		8010693070800

## COLORI DISPONIBILI

Available colors



Rosso  
Red



Arancio  
Orange



Verde  
Green



Blu  
Blue

Tutte le misure sono espresse in millimetri / All measures are in millimeters

# Linea **TEMPO**

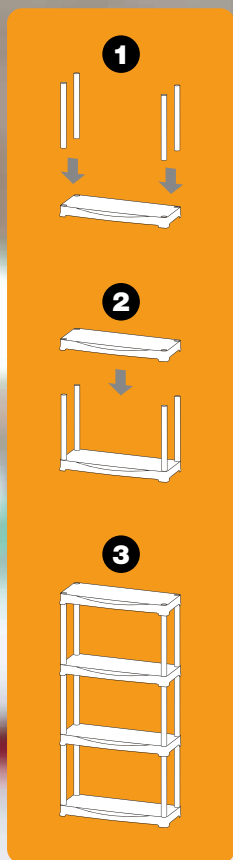

Portata statica  
testata da:  
*Static load tested by:*



Certificato n.  
Z1A170187737003

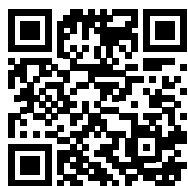

# > Linea **TEMPO**

Prodotto italiano ecosostenibile  
Eco-sustainable italian product



prodotto in polipropilene  
produced in polypropylene



non assorbe gli odori  
odor-proof



non trattiene umidità  
doesn't retain humidity



semplice sistema di assemblaggio  
easy assembly system

**DISPONIBILE NEL COLORE  
ECRÙ SU RICHIESTA**

*On request ecrù color available*



LARGHEZZA  
WIDTH

60 cm



**T60/3**



**T60/4**



**T60/4E**



**T60/5**

## ARTICOLO / ARTICLE

	Larghezza Width	Profondità Depth	Altezza Height	Colore Color	Codice a barre Barcode
<b>T60/3</b>	600	300	900		8010693114825
<b>T60/4</b>	600	300	1330		8010693108039
<b>T60/4E</b>	600	300	1330		8010693118519
<b>T60/5</b>	600	300	1760		8010693114757

## IMBALLO / PACKING

Pz. Pc.	Tipo Type	Larghezza Width	Profondità Depth	Altezza Height
1	Film termoretrato Shrunked film	290	600	124
1	Film termoretrato Shrunked film	290	600	165
1	Film termoretrato Shrunked film	290	600	165
1	Film termoretrato Shrunked film	290	600	207

Tutte le misure sono espresse in millimetri / All measures are in millimeters

# > Linea **TEMPO**

LARGHEZZA  
WIDTH

70 cm

LARGHEZZA  
WIDTH

70 cm

LARGHEZZA  
WIDTH

80 cm



**DISPONIBILE IN DUE COLORI**

*Two colors available*



**T70/4**



**T70/5**



**T80/5**

## ARTICOLO / ARTICLE

	Larghezza Width	Profondità Depth	Altezza Height	Colore Color	Codice a barre Barcode
<b>T70/4</b>	700	300	1330		8010693066902
<b>T70/5</b>	700	300	1760		8010693067008
<b>T80/5</b>	800	400	1760		8010693115143
<b>T80/5E</b>	800	400	1760		8010693122189

## IMBALLO / PACKING

Pz. Pc.	Tipo Type	Larghezza Width	Profondità Depth	Altezza Height
1	Film termoretrato Shrunked film	300	700	185
1	Film termoretrato Shrunked film	300	700	235
1	Film termoretrato Shrunked film	390	800	245
1	Film termoretrato Shrunked film	390	800	245

Tutte le misure sono espresse in millimetri / All measures are in millimeters



prodotto in polipropilene  
produced in polypropylene



non assorbe gli odori  
odor-proof



non trattiene umidità  
doesn't retain humidity



semplice sistema di assemblaggio  
easy assembly system

Prodotto italiano ecosostenibile  
Eco-sustainable italian product



LARGHEZZA  
WIDTH

90 cm

LARGHEZZA  
WIDTH

100 cm



HOME



**T90/5**



**T100/5**



Barre in ferro poste sotto ogni ripiano per aumentarne la portata

*Iron bar to increase the load capacity of shelves*

ARTICOLO / ARTICLE

Larghezza Width	Profondità Depth	Altezza Height	Colore Color	Codice a barre Barcode
--------------------	---------------------	-------------------	-----------------	---------------------------

<b>T90/5</b>	900	400	1760	■	8010693118366
--------------	-----	-----	------	---	---------------

<b>T100/5</b>	1000	450	1760	■	8010693119288
---------------	------	-----	------	---	---------------

IMBALLO / PACKING

Pz. Pc.	Tipo Type	Larghezza Width	Profondità Depth	Altezza Height
------------	--------------	--------------------	---------------------	-------------------

1	Film termoretrato Shrunked film	390	900	245
---	------------------------------------	-----	-----	-----

1	Film termoretrato Shrunked film	450	1000	240
---	------------------------------------	-----	------	-----

Tutte le misure sono espresse in millimetri / All measures are in millimeters

# > Linea **TEMPO plus**

LARGHEZZA  
WIDTH

60 cm



LARGHEZZA  
WIDTH

80 cm





**T60/10 PLUS**



**T80/10 PLUS**

## ARTICOLO / ARTICLE

Larghezza Width	Profondità Depth	Altezza Height	Colore Color	Codice a barre Barcode
600	585	1760		8010693117246
800	775	1760		8010693117253

## IMBALLO / PACKING

Pz. Pc.	Tipo Type	Larghezza Width	Profondità Depth	Altezza Height
1	Film termoretrato Shrunked film	290	600	410
1	Film termoretrato Shrunked film	390	800	478

Tutte le misure sono espresse in millimetri / All measures are in millimeters



prodotto in polipropilene  
produced in polypropylene



non assorbe gli odori  
odor-proof



non trattiene umidità  
doesn't retain humidity



semplice sistema di assemblaggio  
easy assembly system



assemblaggio senza uso di utensili  
assembly without use of tools

Prodotto italiano ecosostenibile  
Eco-sustainable italian product



LARGHEZZA  
WIDTH

90 cm

LARGHEZZA  
WIDTH

100 cm



**T90/10 PLUS**



**T100/10 PLUS**

ARTICOLO / ARTICLE

IMBALLO / PACKING

	Larghezza Width	Profondità Depth	Altezza Height	Colore Color	Codice a barre Barcode	Pz. Pc.	Tipo Type	Larghezza Width	Profondità Depth	Altezza Height
<b>T90/10 PLUS</b>	900	775	1760		8010693118502	1	Film termoretrato Shrunked film	390	900	478
<b>T100/10 PLUS</b>	1000	875	1760		8010693122271	1	Film termoretrato Shrunked film	450	1000	480

Tutte le misure sono espresse in millimetri / All measures are in millimeters

# > PORTATUTTO

Due fori possono diventare un'asola seguendo i tagli incisi sul retro del ripiano

*Two holes can become a slot following the pre-cuts on the back of the shelf*



Kit di 2 elementi per l'ancoraggio al muro

*Hook for wall mounting*



Si possono unire da 2 a 4 articoli creando un modulo da 180° a 360°

*2 to 4 items can be combined to create a 180° to 360° module*



**T29/N**

Angolare portatutto in polipropilene a 2 ripiani da fissare al muro o agganciabile a tutti gli scaffali della Linea TEMPO. Completo di piedini, agganci per fissaggio a parete e tappi finitura

*Corner shelf in polypropylene with 2 shelves, to be fixed to the wall or hooked to all the shelves of TEMPO Line. Complete with feet, hooks for wall mounting and finishing caps*

## ARTICOLO / ARTICLE

## IMBALLO / PACKING

	Larghezza Width	Profondità Depth	Altezza Height	Codice a barre Barcode	Pz. Pc.	Tipo Type	Larghezza Width	Profondità Depth	Altezza Height
<b>T29/N</b>	290	290	665	8010693119202	1	Film termoretrato Shrunked film	600	300	42

Tutte le misure sono espresse in millimetri / All measures are in millimeters





prodotto in polipropilene  
produced in polypropylene



non assorbe gli odori  
odor-proof



non trattiene umidità  
doesn't retain humidity



semplice sistema di assemblaggio  
easy assembly system



assemblaggio senza uso di utensili  
assembly without to use of tools

Prodotto italiano ecosostenibile  
Eco-sustainable italian product



Angolare portascopie in polipropilene a 2 ripiani + scaffale 4 ripiani, possibilità di montare l'angolare a destra o a sinistra dello scaffale

*Corner shelf in polypropylene with 2 shelves + 4 shelves, possibility of mounting the corner piece to the right or left side of the shelf*



**PORTATUTTO CON SCAFFALE 4 RIPIANI**

*Corner shelf with 4 shelves*

**T29N+T60/4**

**ARTICOLO / ARTICLE**

**IMBALLO / PACKING**

	Larghezza Width	Profondità Depth	Altezza Height	Codice a barre Barcode	Pz. Pc.	Tipo Type	Larghezza Width	Profondità Depth	Altezza Height
<b>T29N+T60/4</b>	890	300	1330	8010693119226	1	Film termoretrato Shrunked film	200	600	300

Tutte le misure sono espresse in millimetri / All measures are in millimeters

# Linea **DAVIDE D+**

Dall'evoluzione della Linea Davide è nata la Linea Davide D+, dove la robustezza è la caratteristica prevalente. Sono stati progettati per sostenere grandi carichi. I ripiani possono essere posizionati in 40 differenti altezze in modo che l'utilizzatore componga lo scaffale su misura per le sue esigenze.

*The Davide D + Line was born from the evolution of the Davide Line, where robustness is the prevailing characteristic. They have been designed to support large loads. The shelves can be positioned in 40 different heights so that the user can make the shelf tailored to his needs.*

Predisposizione per il fissaggio a parete  
*Prepared for wall mounting*

40 livelli di posizionamento dei ripiani  
*40 levels of shelf placement*

Ripiani riposizionabili in altezza  
*Shelves adjustable in height*

Ganci laterali multiuso  
*Side hooks*



# > Linea **DAVIDE D+**

Prodotto italiano ecosostenibile  
Eco-sustainable italian product



prodotto in polipropilene  
produced in polypropylene



non assorbe gli odori  
odor-proof



non trattiene umidità  
doesn't retain humidity



semplice sistema di assemblaggio  
easy assembly system



assemblaggio senza uso di utensili  
assembly without use of tools

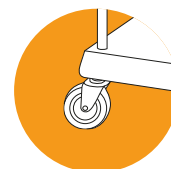

Carrellabile opzionale  
*Optional wheels*

LARGHEZZA  
WIDTH  
**70 cm**



**STRONGER!**

LARGHEZZA  
WIDTH  
**80 cm**

LARGHEZZA  
WIDTH  
**90 cm**



**D+70355**



**D+80405**



Montante opzionale  
*Optional column*

**D+90455**

## RIPIANI RIPOSIZIONABILI IN ALTEZZA

*Shelves adjustable in height*

### ARTICOLO / ARTICLE

	Larghezza Width	Profondità Depth	Altezza Height	Codice a barre Barcode
<b>D+70355</b>	720	350	1645	8010693051403
<b>D+80405</b>	820	400	1645	8010693051700
<b>D+90455</b>	920	450	1645	8010693052004

### IMBALLO / PACKING

Pz. Pc.	Tipo Type	Larghezza Width	Profondità Depth	Altezza Height
1	cartone/carton	745	265	365
1	cartone/carton	836	257	411
1	cartone/carton	936	257	460

Tutte le misure sono espresse in millimetri / All measures are in millimeters

> Linea **DAVIDE D+**

Prodotto italiano ecosostenibile  
Eco-sustainable italian product



# CANTINETTA

PORTA BOTTIGLIE

*Wine rack*

Predisposizione per il  
fissaggio a parete

*Prepared for wall  
mounting*



prodotto in  
polipropilene  
produced in  
polypropylene



non assorbe  
gli odori  
odor-proof



non trattiene  
umidità  
doesn't retain  
humidity



semplice sistema  
di assemblaggio  
easy assembly  
system

**D+70234**

Componibili e  
regolabili su misura

*Modular and  
adjustable racks*

**D+70232**

Kit 2 ripiani aggiuntivi  
per cantinetta con  
relative colonne

*Kit 2 additional shelves  
for wine cellar with its  
columns*

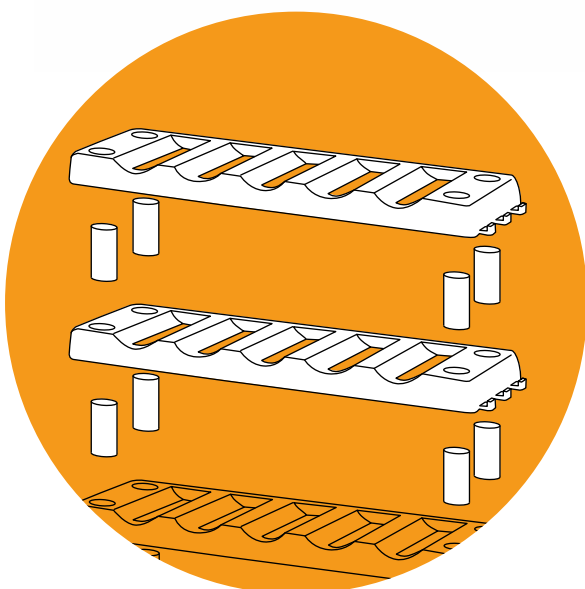

## ARTICOLO / ARTICLE

	Larghezza Width	Profondità Depth	Altezza Height	Codice a barre Barcode
<b>D+70234</b>	715	220	495	8010693058808
<b>D+70232</b>	715	220	245	8010693059706

## IMBALLO / PACKING

Pz. Pc.	Tipo Type	Larghezza Width	Profondità Depth	Altezza Height
1	film termoretrato/ shrinked film	720	225	200
1	film termoretrato/ shrinked film	715	220	490

Tutte le misure sono espresse in millimetri / All measures are in millimeters

# > Linea SHEEL

CARRELLO MULTI USO

Multi-use trolley

Prodotto italiano ecosostenibile  
Eco-sustainable italian product



Maniglia di presa  
Carry handle

Ripiano  
riposizionabile  
in altezza  
Shelf adjustable  
in height

Bordi rialzati  
Raised borders



prodotto in  
polipropilene  
produced in  
polypropylene



non assorbe  
gli odori  
odor-proof



non trattiene  
umidità  
doesn't retain  
humidity



semplice sistema  
di assemblaggio  
easy assembly  
system

Ruote in acciaio  
Steel wheels

**D+75373**



Immagine su due lati, packaging ingegnerizzato per contenere al minimo il volume del prodotto e i costi di trasporto

Dual-front illustration, engineered packing to limit the volume of the products and the freight costs

## ARTICOLO / ARTICLE

Larghezza Width	Profondità Depth	Altezza Height	Codice a barre Barcode
750	375	920	8010693053803

**D+75373**

## IMBALLO / PACKING

Pz. Pc.	Tipo Type	Larghezza Width	Profondità Depth	Altezza Height
1	cartone/carton	760	162	381

Tutte le misure sono espresse in millimetri / All measures are in millimeters

# Linea **DOLLY**



4 Maniglie di presa  
4 carry handles



# > Linea **DOLLY**

Prodotto italiano ecosostenibile  
Eco-sustainable italian product



prodotto in polipropilene  
produced in polypropylene



non assorbe gli odori  
odor-proof



non trattiene umidità  
doesn't retain humidity



semplice sistema di assemblaggio  
easy assembly system



**L1410N**

**PIATTAFORMA SPOSTABILI CON 8 RUOTE**

*Moving furniture platform with 8 wheels*



**L3610N**

**PIATTAFORMA RETTANGOLARE CON 4 RUOTE**

*Rectangular platform with 4 wheels*

**SISTEMA ANTI-TORSIONE**

*No torsion system*



## ARTICOLO / ARTICLE

	Larghezza Width	Profondità Depth	Altezza Height	Codice a barre Barcode
<b>L1410N</b>	140	105	25	8010693121014
<b>L3610N</b>	360	100	80	8010693121007

## IMBALLO / PACKING

	Pz. Pc.	Tipo Type	Larghezza Width	Profondità Depth	Altezza Height
	28	cartone/carton	203	206	250
	15	cartone/carton	225	259	366

Tutte le misure sono espresse in millimetri / All measures are in millimeters

# > Linea **DOLLY**



Portata statica  
*Static load*

Sistema di aggancio per poter ampliare la pedana su 4 lati

*Hooking system to expand the platform 4 sides*

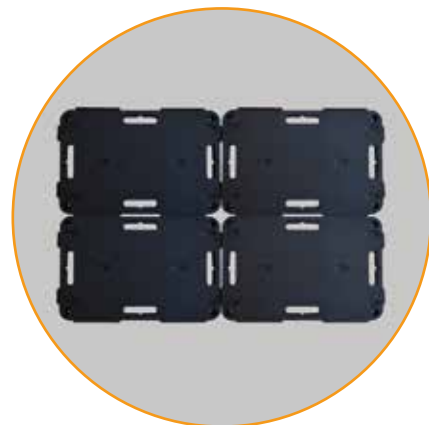

Foro per inserire la corda per facilitare lo spostamento

*Hole to insert the rope to facilitate movement*



**L4829N**

Ottimizzazione degli spazi, packaging minimo

*Spaces optimization, reduced packaging*

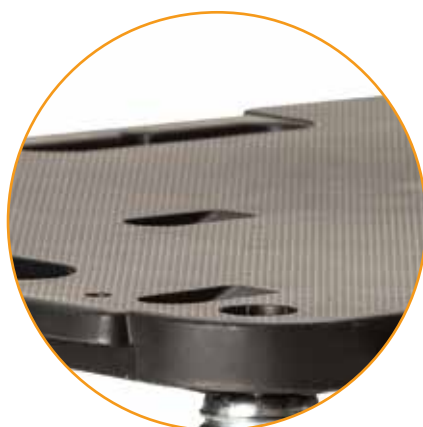

Superficie gofrata antiscivolo

*Non-slip embossed surface*

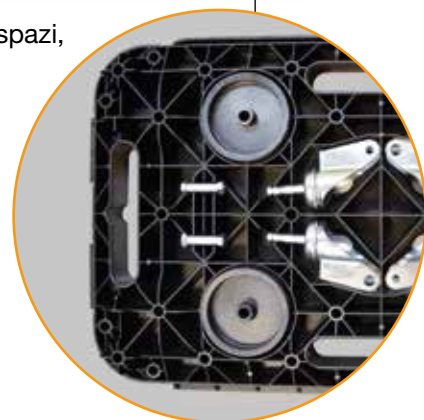

## ARTICOLO / ARTICLE

Larghezza Width	Profondità Depth	Altezza Height	Codice a barre Barcode
480	290	125	8010693119325

## IMBALLO / PACKING

Pz. Pc.	Tipo Type	Larghezza Width	Profondità Depth	Altezza Height
10	cartone/carton	485	295	385

Tutte le misure sono espresse in millimetri / All measures are in millimeters





prodotto in polipropilene  
produced in polypropylene



non assorbe gli odori  
odor-proof



non trattiene umidità  
doesn't retain humidity



semplice sistema di assemblaggio  
easy assembly system



assemblaggio senza uso di utensili  
assembly without use of tools

Prodotto italiano ecosostenibile  
Eco-sustainable italian product



Portata statica testata da:  
*Static load tested by:*



**L2R**

+ 2 ruote centrali di rinforzo per aumentare la portata

+ 2 central reinforcement wheels to increase the load capacity



**L5838N**



Super resistenza in acciaio  
*Steel wheel support*



**ARTICOLO / ARTICLE**

**IMBALLO / PACKING**

	Larghezza Width	Profondità Depth	Altezza Height	Codice a barre Barcode
<b>L5838N</b>	580	380	120	8010693119196
<b>L2R</b>	170	30	170	8010693119264

Pz. Pc.	Tipo Type	Larghezza Width	Profondità Depth	Altezza Height
5	cartone/carton	660	399	199
15	cartone/carton	203	206	250

Tutte le misure sono espresse in millimetri / All measures are in millimeters

# > Linea **DOLLY**

Prodotto italiano ecosostenibile  
Eco-sustainable italian product



prodotto in polipropilene  
produced in polypropylene



non assorbe gli odori  
odor-proof



non trattiene umidità  
doesn't retain humidity



semplice sistema di assemblaggio  
easy assembly system



assemblaggio senza uso di utensili  
assembly without use of tools



**L3030N**

∅ 300 mm



## ARTICOLO / ARTICLE

Larghezza Width	Profondità Depth	Altezza Height	Codice a barre Barcode
300	300	70	8010693120987

## IMBALLO / PACKING

Pz. Pc.	Tipo Type	Larghezza Width	Profondità Depth	Altezza Height
14	cartone/carton	300	300	540

Tutte le misure sono espresse in millimetri / All measures are in millimeters

# > Linea **DOLLY**

Prodotto italiano ecosostenibile  
Eco-sustainable italian product



prodotto in polipropilene  
produced in polypropylene



non assorbe gli odori  
odor-proof



non trattiene umidità  
doesn't retain humidity



semplice sistema di assemblaggio  
easy assembly system



assemblaggio senza uso di utensili  
assembly without use of tools



**L4040N**

∅ 400 mm



## ARTICOLO / ARTICLE

Larghezza Width	Profondità Depth	Altezza Height	Codice a barre Barcode
--------------------	---------------------	-------------------	---------------------------

## IMBALLO / PACKING

Pz. Pc.	Tipo Type	Larghezza Width	Profondità Depth	Altezza Height
------------	--------------	--------------------	---------------------	-------------------

<b>L4040N</b>	400	400	125	8010693120994	10	cartone/carton	400	400	400
---------------	-----	-----	-----	---------------	----	----------------	-----	-----	-----

Tutte le misure sono espresse in millimetri / All measures are in millimeters

NEW! NEW! NEW! NEW!

Linea

- > **EASY**
- > **FREE**
- > **FAMILY**
- > **IDEA**

**Eco**

Ideale per separare e contenere i rifiuti in modo ordinato, la Linea Eco di questi armadi è una soluzione comoda per la raccolta differenziata. La chiusura di sicurezza garantisce protezione dal vento e da aperture accidentali. L'anello portasacco è particolarmente robusto al fine di evitare rotture. Pratico per sfruttare al meglio lo spazio, può essere posizionato anche all'esterno in giardino, balcone, terrazzo, cantina e garage. Il modello Eco può contenere al suo interno tre sacchi da 110 litri ciascuno, mentre il modello Eco3 arriva fino a 70 litri e ciascun sacco poggia su un ripiano.

*Ideal for separating and storing waste in an orderly manner, the Eco Line of these cabinets is a convenient solution for separate collection. The safety lock provides protection from wind and accidental openings. The holder ring is particularly robust in order to avoid breakage. Practical to make the most of the space, it can also be placed outside in the garden, balcony, terrace, cellar and garage. The Eco model can contain three 110 liter bags each, while the Eco3 model reaches up to 70 liters and each bag rests on a shelf.*

Logo personalizzabile  
Customizable logo



# > Linea **EASY** Eco

Prodotto italiano ecosostenibile  
Eco-sustainable italian product



prodotto in polipropilene  
produced in polypropylene



non assorbe gli odori  
odor-proof



non trattiene umidità  
doesn't retain humidity



semplice sistema di assemblaggio  
easy assembly system



Ripiani regolabili in altezza

*Shelves adjustable in height*



**E71/ECO**



**E71/ECO3**



**E101/ECO**



## ARTICOLO / ARTICLE

	Larghezza Width	Profondità Depth	Altezza Height	Codice a barre Barcode
<b>E71/ECO</b>	680	370	840	8010693124480
<b>E71/ECO3</b>	680	370	840	8010693124909
<b>E101/ECO</b>	1020	370	840	8010693124497

## IMBALLO / PACKING

Pz. Pc.	Tipo Type	Larghezza Width	Profondità Depth	Altezza Height
1	cartone/carton	800	135	689
1	cartone/carton	800	135	689
1	cartone/carton	800	140	1025

Tutte le misure sono espresse in millimetri / All measures are in millimeters

# > Linea **FREE** Eco



prodotto in polipropilene  
produced in polypropylene



non assorbe gli odori  
odor-proof



non trattiene umidità  
doesn't retain humidity



semplice sistema di assemblaggio  
easy assembly system



**F71/ECO**



Ripiani regolabili in altezza  
*Shelves adjustable in height*



**F71/ECO3**





prodotto in polipropilene  
produced in polypropylene



non assorbe gli odori  
odor-proof



non trattiene umidità  
doesn't retain humidity



semplice sistema di assemblaggio  
easy assembly system

Prodotto italiano ecosostenibile  
Eco-sustainable italian product



**F101/ECO**



**ARTICOLO / ARTICLE**

	Larghezza Width	Profondità Depth	Altezza Height	Codice a barre Barcode
<b>F71/ECO</b>	680	370	840	8010693124503
<b>F71/ECO3</b>	680	370	840	8010693124916
<b>F101/ECO</b>	1020	370	840	8010693124510

**IMBALLO / PACKING**

Pz. Pc.	Tipo Type	Larghezza Width	Profondità Depth	Altezza Height
1	cartone/carton	800	135	689
1	cartone/carton	800	135	689
1	cartone/carton	800	140	1025

Tutte le misure sono espresse in millimetri / All measures are in millimeters

# > Linea **FAMILY** Eco



prodotto in polipropilene  
produced in polypropylene



non assorbe gli odori  
odor-proof



non trattiene umidità  
doesn't retain humidity



semplice sistema di assemblaggio  
easy assembly system



Ripiani regolabili in altezza

*Shelves adjustable in height*



**F70/ECO**



**F70/ECO3**



**F70/ECOLOR3**

## ARTICOLO / ARTICLE

	Larghezza Width	Profondità Depth	Altezza Height	Codice a barre Barcode
<b>F70/ECO</b>	680	370	900	8010693124527
<b>F70/ECO3</b>	680	370	900	8010693124923
<b>F70/ECOLOR3</b>	680	370	900	8010693124930

## IMBALLO / PACKING

Pz. Pc.	Tipo Type	Larghezza Width	Profondità Depth	Altezza Height
1	cartone/carton	800	135	689
1	cartone/carton	800	135	689
1	cartone/carton	800	135	689

Tutte le misure sono espresse in millimetri / All measures are in millimeters





prodotto in polipropilene  
produced in polypropylene



non assorbe gli odori  
odor-proof



non trattiene umidità  
doesn't retain humidity



semplice sistema di assemblaggio  
easy assembly system

Prodotto italiano ecosostenibile  
Eco-sustainable italian product



**F100/ECO**



**F100/ECOLOR**

ARTICOLO / ARTICLE

	Larghezza Width	Profondità Depth	Altezza Height	Codice a barre Barcode
<b>F100/ECO</b>	1020	370	900	8010693124534
<b>F100/ECOLOR</b>	1020	370	900	8010693124602

IMBALLO / PACKING

Pz. Pc.	Tipo Type	Larghezza Width	Profondità Depth	Altezza Height
1	cartone/carton	800	140	1025
1	cartone/carton	800	140	1025

Tutte le misure sono espresse in millimetri / All measures are in millimeters

# > Linea **IDEA** Eco



prodotto in polipropilene  
produced in polypropylene



non assorbe gli odori  
odor-proof



non trattiene umidità  
doesn't retain humidity



semplice sistema di assemblaggio  
easy assembly system



Ripiani regolabili in altezza

*Shelves adjustable in height*



**I70/ECO**



**I70/ECO3**



**I70/ECOLOR3**

## ARTICOLO / ARTICLE

	Larghezza Width	Profondità Depth	Altezza Height	Codice a barre Barcode
<b>I70/ECO</b>	680	370	900	8010693124541
<b>I70/ECO3</b>	680	370	900	8010693124947
<b>I70/ECOLOR3</b>	680	370	900	8010693124954

## IMBALLO / PACKING

Pz. Pc.	Tipo Type	Larghezza Width	Profondità Depth	Altezza Height
1	cartone/carton	800	135	689
1	cartone/carton	800	135	689
1	cartone/carton	800	135	689

Tutte le misure sono espresse in millimetri / All measures are in millimeters



prodotto in polipropilene  
produced in polypropylene



non assorbe gli odori  
odor-proof



non trattiene umidità  
doesn't retain humidity



semplice sistema di assemblaggio  
easy assembly system

Prodotto italiano ecosostenibile  
Eco-sustainable italian product



**I100/ECO**



**I100/ECOLOR**

**ARTICOLO / ARTICLE**

	Larghezza Width	Profondità Depth	Altezza Height	Codice a barre Barcode
<b>I100/ECO</b>	1020	370	900	8010693124558
<b>I100/ECOLOR</b>	1020	370	900	8010693124589

**IMBALLO / PACKING**

Pz. Pc.	Tipo Type	Larghezza Width	Profondità Depth	Altezza Height
1	cartone/carton	800	140	1025
1	cartone/carton	800	140	1025

Tutte le misure sono espresse in millimetri / All measures are in millimeters

## Linea **ECO-LOGICO**

### CONTENITORE PER RACCOLTA DIFFERENZIATA

I contenitori per la raccolta differenziata sono stati appositamente studiati per rendere più facile la raccolta dei rifiuti. Si possono creare composizioni diverse in quanto sono incastrabili e predisposti per il fissaggio a parete. Le dimensioni di questo articolo consentono la collocazione di tre moduli sotto al lavello; essi sono infatti inferiori a 120 cm di larghezza, misura standard per questo vano. Senza secchiello, sono anche utilizzati come contenitori multiuso.

### **BIN FOR RECYCLING**

*The re-cycle bins have been studied to simplify every sorted of waste. The modular and stackable unit are predisposed to be fixed on the wall, creating many configurations fit to home spaces. The dimensions are designed to be placed under the sink: three units are 120 cm, standard sizes for this compartment. Without the bucket, they are also used as multi-use containers.*

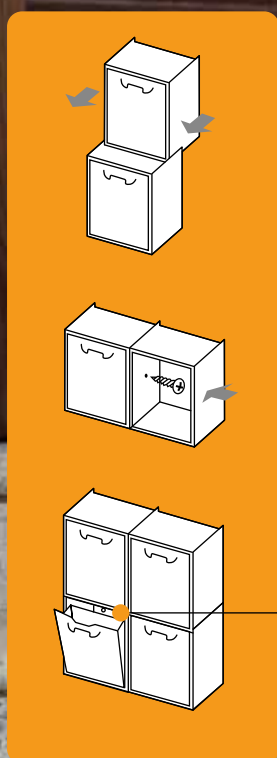

**Secchio interno incluso**  
*Internal bucket included*

# > Linea **ECO-LOGICO**

Prodotto italiano ecosostenibile  
Eco-sustainable italian product



prodotto in polipropilene  
produced in polypropylene



non assorbe gli odori  
odor-proof



non trattiene umidità  
doesn't retain humidity

Adatti sia per interni che esterni, sono disponibili in vari colori per facilitare il riconoscimento

*Suitable for the interior and the exterior, available in various colors to facilitate recognition*

Impilabili e incastrabili verticalmente e predisposti per il fissaggio a parete

*Stackable and predisposed for wall and sideways fixing*

Busta con 6 adesivi applicabili su superfici piane  
*Envelope with 6 stickers*  
*Applicables on flat surfaces*



**ADDIF/20**



## ARTICOLO / ARTICLE

Larghezza Width	Profondità Depth	Altezza Height	Codice a barre Barcode
150	2	230	8010693125104

## IMBALLO / PACKING

Pz. Pc.	Tipo Type	Larghezza Width	Profondità Depth	Altezza Height
10	cartone/carton	203	206	250

**ADDIF/20**

# > Linea **ECO-LOGICO**



**R34/1WS**



**R34/1S**



**R34/1B**



**R34/1V**



**R34/1G**



**R34/1R**

## ARTICOLO / ARTICLE

	Larghezza Width	Profondità Depth	Altezza Height	Colore Color	Codice a barre Barcode
<b>R34/1WS</b>	340	290	470		8010693055500
<b>R34/1S</b>	340	290	470		8010693055302
<b>R34/1B</b>	340	290	470		8010693068401
<b>R34/1V</b>	340	290	470		8010693068609
<b>R34/1G</b>	340	290	470		8010693068500
<b>R34/1R</b>	340	290	470		8010693068708

## IMBALLO / PACKING

Pz. Pc.	Tipo Type	Larghezza Width	Profondità Depth	Altezza Height
1	cartone/carton	488	300	347
1	cartone/carton	488	300	347
1	cartone/carton	488	300	347
1	cartone/carton	488	300	347
1	cartone/carton	488	300	347
1	cartone/carton	488	300	347

Tutte le misure sono espresse in millimetri / All measures are in millimeters



prodotto in polipropilene  
produced in polypropylene



non assorbe gli odori  
odor-proof



non trattiene umidità  
doesn't retain humidity

Prodotto italiano ecosostenibile  
Eco-sustainable italian product



Busta con 6 adesivi applicabili su superfici piane  
*Envelope with 6 stickers Applicables on flat surfaces*



**ADDIF**



Gancio incluso per fissaggio a parete  
*Hook included for wall mounting*

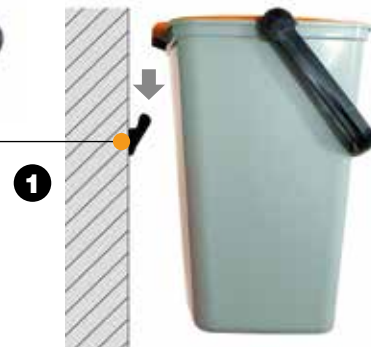

**RS/4**

**15 LITRI**



**ARTICOLO / ARTICLE**

Larghezza Width	Profondità Depth	Altezza Height	Codice a barre Barcode
305	265	355	8010693069606

**IMBALLO / PACKING**

Pz. Pc.	Tipo Type	Larghezza Width	Profondità Depth	Altezza Height
1	cartone/carton	307	267	417

**RS/4**

Tutte le misure sono espresse in millimetri / All measures are in millimeters

# Linea **BIOSYSTEM**

## CASSONETTO PER RACCOLTA DIFFERENZIATA

I cassonetti per la raccolta differenziata sono stati studiati per rendere più facile la raccolta dei rifiuti.

### **BIN FOR RECYCLING**

*The re-cycle bins have been studied to simplify every sorted of waste.*

Evita gli accumuli di acqua  
*Dripping-off system*



**Manico autobloccante  
antirandagismo**  
*Anti stray self-locking  
handle*



**Base con spessore  
maggiorato**  
*Increased thickness  
on the base*

**Maniglia per  
lo svuotamento**  
*Emptying  
handle*





# > Linea **BIOSYSTEM**

Prodotto italiano ecosostenibile  
Eco-sustainable italian product



prodotto in polipropilene  
produced in polypropylene



non assorbe gli odori  
odor-proof



non trattiene umidità  
doesn't retain humidity



\* **BS7/V** 7 LITRI  
Litres



**BS7/M** 7 LITRI  
Litres



**BS10/V** 10 LITRI  
Litres



**BS10/M** 10 LITRI  
Litres

**\*ADESIVO NON INCLUSO**  
Sticker not included



**ADDIF**

Busta con 6 adesivi applicabili su superfici piane

Envelope with 6 stickers applicables on flat surfaces

## ARTICOLO / ARTICLE

## IMBALLO / PACKING

	Larghezza Width	Profondità Depth	Altezza Height	Codice a barre Barcode	Pz. Pc.	Tipo Type	Larghezza Width	Profondità Depth	Altezza Height
<b>BS7/V</b>	237	240	205	8010693077403	17	cartone/carton	325	235	945
<b>BS7/M</b>	237	240	205	8010693077304	17	cartone/carton	325	235	945
<b>BS10/V</b>	237	240	300	8010693077601	15	cartone/carton	325	235	945
<b>BS10/M</b>	237	240	300	8010693077502	15	cartone/carton	325	235	945

Tutte le misure sono espresse in millimetri / All measures are in millimeters

# > Linea **BIOSYSTEM**

CASSONETTO PER RACCOLTA DIFFERENZIATA

*Bin for recycling*

**30** LITRI  
*Litres*



Busta con 6 adesivi applicabili su superfici piane

*Envelope with 6 stickers  
Applicables on flat surfaces*



**BS30/GG**



**BS30/VG**



**ADDIF**



**BS30/BG**



**BS30/MG**



**BS30/RG**

## ARTICOLO / ARTICLE

	Larghezza Width	Profondità Depth	Altezza Height	Codice a barre Barcode
<b>BS30G</b>	400	305	390	8010693117222
<b>BS30V</b>	400	305	390	8010693117215
<b>BS30R</b>	400	305	390	8010693117208
<b>BS30B</b>	400	305	390	8010693117192
<b>BS30M</b>	400	305	390	8010693117239

## IMBALLO / PACKING

Pz. Pc.	Tipo Type	Larghezza Width	Profondità Depth	Altezza Height
8	cartone/carton	400	380	772
8	cartone/carton	400	380	772
8	cartone/carton	400	380	772
8	cartone/carton	400	380	772
8	cartone/carton	400	380	772

Tutte le misure sono espresse in millimetri / All measures are in millimeters



prodotto in polipropilene  
produced in polypropylene



non assorbe gli odori  
odor-proof



non trattiene umidità  
doesn't retain humidity

Prodotto italiano ecosostenibile  
Eco-sustainable italian product



**35 LITRI**  
Litres



Busta con 6 adesivi applicabili su superfici piane

Envelope with 6 stickers  
Applicable on flat surfaces



**BS35/GG**



**BS35/VG**



**BS35/RG**



**BS35/BG**



**BS35/MG**

ARTICOLO / ARTICLE

IMBALLO / PACKING

	Larghezza Width	Profondità Depth	Altezza Height	Codice a barre Barcode
<b>BS35G</b>	400	305	510	8010693077700
<b>BS35V</b>	400	305	510	8010693077809
<b>BS35R</b>	400	305	510	8010693077908
<b>BS35B</b>	400	305	510	8010693078004
<b>BS35M</b>	400	305	510	8010693078202

Pz. Pc.	Tipo Type	Larghezza Width	Profondità Depth	Altezza Height
6	cartone/carton	400	380	772
6	cartone/carton	400	380	772
6	cartone/carton	400	380	772
6	cartone/carton	400	380	772
6	cartone/carton	400	380	772

Tutte le misure sono espresse in millimetri / All measures are in millimeters

Linea  
**BIOSYSTEM**



**Manico autobloccante  
antirandagismo**

*Anti stray self-locking  
handle*

**Base con spessore  
maggiorato**

*Increased thickness on  
the base*

# > Linea **BIOSYSTEM**

Prodotto italiano ecosostenibile  
Eco-sustainable italian product



prodotto in polipropilene  
produced in polypropylene



non assorbe gli odori  
odor-proof



non trattiene umidità  
doesn't retain humidity

**30 LITRI**  
Litres

Busta con 6 adesivi applicabili su superfici piane

*Envelope with 6 stickers  
Applicables on flat surfaces*



**ADDIF**

Evita gli accumuli di acqua  
*Dripping-off system*



**BS30/LOT3**

## ARTICOLO / ARTICLE

Larghezza Width	Profondità Depth	Altezza Height	Codice a barre Barcode
400	305	390	8010693123377

## IMBALLO / PACKING

Pz. Pc.	Tipo Type	Larghezza Width	Profondità Depth	Altezza Height
2	cartone/carton	383	396	760

**BS30/LOT3**

Linea  
**ECO-  
TRESPOLO**

**ECOTRESPOLO GRIGLIATO IN  
POLIPROPILENE**

I nuovi trespoli sono contenitori grigliati porta sacco per la raccolta dei rifiuti. Sono robusti, facili da utilizzare e particolarmente adatti per sacchi fino a 110 lt. Sono consegnati già montati, pronti per l'utilizzo.

**POLYPROPYLENE ECOBIN**

*The new Eco-bins are perforated containers for every sorted of waste. They are robust, easy to use and particularly useful for bags up to 110 lt. It isn't necessary any assembling, every article arrives ready to be used.*

Apertura del coperchio a 90°  
*Lid opening at 90 degrees*

Non richiedono assemblaggio,  
si presentano pronti per  
l'utilizzo

*No assembly needed, each  
item is delivered ready to be  
used*

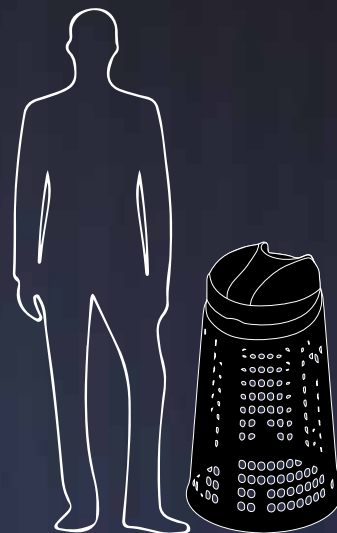
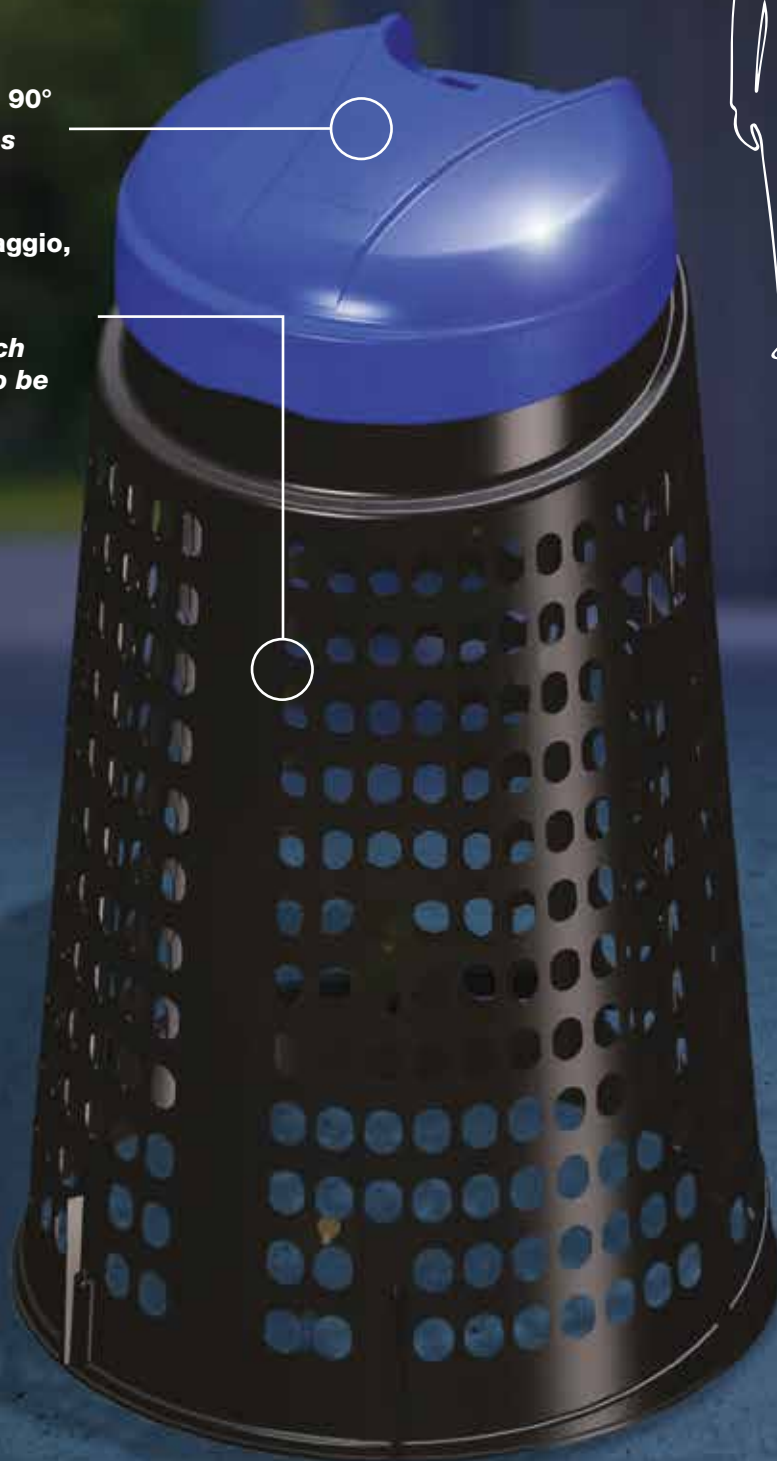

# > Linea **ECOTRESPOLO**

Prodotto italiano ecosostenibile  
Eco-sustainable italian product



prodotto in polipropilene  
produced in polypropylene



non assorbe gli odori  
odor-proof



non trattiene umidità  
doesn't retain humidity



assemblaggio senza uso di utensili  
assembly without to use of tools



**TR/BN**



**TR/GN**



**TR/RN**



**TR/VN**

Busta con 6 adesivi applicabili su superfici piane

*Envelope with 6 stickers  
Applicables on flat surfaces*



**ADDIF**

## ARTICOLO / ARTICLE

	∅	∅ Inf.	Litri	Altezza	Codice a barre
	∅	∅ inf.	Liter	Height	Barcode
<b>TR/BN</b>	370	500	110	855	8010693091508
<b>TR/VN</b>	370	500	110	855	8010693091201
<b>TR/RN</b>	370	500	110	855	8010693091409
<b>TR/GN</b>	370	500	110	855	8010693091300

Tutte le misure sono espresse in millimetri / All measures are in millimeters

## Linea **UFFICIO**

La linea comprende alcuni prodotti per l'ufficio, ma utilizzati anche in casa, come i cestini gettacarta e i porta-corrispondenza, stampati ad iniezione, solidi e consistenti.

*The line includes some products for the office, but they can be also used at home like the waste paper baskets and containers to collect the mails. They are produced with injection press machines.*





# > Linea **UFFICIO**

Prodotto italiano ecosostenibile  
Eco-sustainable italian product



prodotto in polipropilene  
produced in polypropylene



non assorbe gli odori  
odor-proof



non trattiene umidità  
doesn't retain humidity



## **PORTACORRISPONDENZA**

*Letter tray*

**KS 3**



## **CESTINO GRIGLIATO**

*Grilled basket*

**KS 1**

**16**

LITRI

Litres



### ARTICOLO / ARTICLE

	Larghezza Width	Profondità Depth	Altezza Height	Codice a barre Barcode
<b>KS 1</b>	300	300	320	8010693020706
<b>KS 3</b>	252	360	65	8010693017706

### IMBALLO / PACKING

Pz. Pc.	Tipo Type	Larghezza Width	Profondità Depth	Altezza Height
12	cartone/carton	650	310	310
14	cartone/carton	450	350	420

Tutte le misure sono espresse in millimetri / All measures are in millimeters

# LIFT

Utile per monitor o portatili, questo supporto adatta lo schermo del computer allineandolo al livello degli occhi, alleviando la tensione su collo, schiena e spalle aumentando nel contempo il comfort per un lavoro ottimale.

Permette inoltre di sfruttare al meglio lo spazio, infatti è possibile sistemare accessori al di sotto dello stesso.

*Useful for monitors or laptops, this support adapts the computer screen aligning it to the eye level, relieving tension on the neck, back and shoulders while increasing comfort for optimal work. It also allows you to make the most of the space, in fact you can place accessories below it.*



# > LIFT

Prodotto italiano ecosostenibile  
Eco-sustainable italian product



prodotto in polipropilene  
produced in polypropylene



non assorbe gli odori  
odor-proof



non trattiene umidità  
doesn't retain humidity



**LIFT58E**

**DISPONIBILE IN DUE COLORI**

*Two colors available*



**LIFT58N**



## ARTICOLO / ARTICLE

## IMBALLO / PACKING

	Larghezza Width	Profondità Depth	Altezza Height	Codice a barre Barcode	Pz. Pc.	Tipo Type	Larghezza Width	Profondità Depth	Altezza Height
<b>LIFT58N</b>	595	255	125	8010693124992	22	cartone/carton	597	395	475
<b>LIFT58E</b>	595	255	125	8010693125043	22	cartone/carton	597	395	475

Tutte le misure sono espresse in millimetri / All measures are in millimeters

# > Linea **GADGET**

Prodotto italiano ecosostenibile  
Eco-sustainable italian product



prodotto in  
polipropilene  
produced in  
polypropylene



non assorbe  
gli odori  
odor-proof



non trattiene  
umidità  
doesn't retain  
humidity

**Colori / colors:**



**170**



**170N**



## ARTICOLO / ARTICLE

	Larghezza Width	Profondità Depth	Altezza Height	Codice a barre Barcode
<b>170</b>	115	10	40	8010693122233
<b>170N</b>	115	10	40	8010693122264

## IMBALLO / PACKING

Pz. Pc.	Tipo Type	Larghezza Width	Profondità Depth	Altezza Height
160	cartone/carton	220	165	245
160	cartone/carton	220	165	245

Tutte le misure sono espresse in millimetri / All measures are in millimeters

# > Linea MIP

Prodotto italiano ecosostenibile  
Eco-sustainable italian product



## DISPOSITIVO DI PROTEZIONE PERSONALE

*Maximum individual protection*



prodotto in polipropilene  
produced in polypropylene



non assorbe gli odori  
odor-proof



non trattiene umidità  
doesn't retain humidity



ultra trasparente  
ultra clear



super leggera  
extra light



indossabile con gli occhiali  
wearable with glasses



trattamento antiappannamento  
anti-fog treatment



Prese d'aria per una migliore traspirazione  
*Air intakes for a better breathability*



Confezione d'imballo  
*Packaging*



**MIP3020B**

A marchio

**CE**

Norma:  
**EN166 3 S**

**DPI**

è un dispositivo di protezione personale (DPI) di Categoria 2

**MIP2617B**

MISURA/Size  
**JUNIOR**



### ARTICOLO / ARTICLE

	Larghezza Width	Profondità Depth	Altezza Height	Codice a barre Barcode
<b>MIP3020B</b>	200	130	200	8010693123353
<b>MIP2617B</b>	170	130	180	8010693123360

### IMBALLO / PACKING

Pz. Pc.	Tipo Type	Larghezza Width	Profondità Depth	Altezza Height
50	cartone/carton	225	259	366
50	cartone/carton	225	259	366

Tutte le misure sono espresse in millimetri / All measures are in millimeters

NEW! NEW! NEW!

Linea  
**VALENTINO  
PROMO**



# > Linea VALENTINO PROMO

Prodotto italiano ecosostenibile  
Eco-sustainable italian product



prodotto in polipropilene  
produced in polypropylene



non assorbe gli odori  
odor-proof



non trattiene umidità  
doesn't retain humidity



**5440**



Logo e testo personalizzabili  
*Customizable logo and text*



**IMBALLO:**  
*Packing:*

## ARTICOLO / ARTICLE

	Larghezza Width	Profondità Depth	Altezza Height	Codice a barre Barcode
<b>5440/ESP</b>	385	285	205	8010693124633
<b>5440/12</b>	385	285	205	8010693124633

## IMBALLO / PACKING

Pz. Pc.	Tipo Type	Larghezza Width	Profondità Depth	Altezza Height
30	cartone/carton	580	385	1050
12	cartone/carton	597	395	475

Tutte le misure sono espresse in millimetri / All measures are in millimeters

# Linea **VALENTINO**

## **VALIGETTE PORTAUTENSILI**

Le valigette portautensili Linea Valentino sono state realizzate con un design moderno e funzionale. I modelli sono sette, a questi si affiancano due valigette porta-trapano, di cui una semplice ed una con vani porta-minuterie, porta-punte e gommapiuma interna.

## **TOOLS BOXES**

*Valentino tool cases line are made with a modern and functional design. There are seven models and two power tool cases: one basic model and the other with tool trays on the cover, a groove for drills and foam rubber inside.*



Maniglia a scomparsa  
*Foldaway handle*



Vani porta-minuteria con coperchio trasparente  
*Storage compartments with transparent lids*



Colori sobri, professionali e di forte impatto cromatico  
*Sober and professional colors with a high chromatic impact*



Vaschetta interna amovibile  
*With inner removable organizer*



# > Linea VALENTINO

Prodotto italiano ecosostenibile  
Eco-sustainable italian product



prodotto in polipropilene  
produced in polypropylene



non assorbe gli odori  
odor-proof



non trattiene umidità  
doesn't retain humidity

HARDWARE



**5400**



**5300**

Con vaschetta interna amovibile  
*With inner removable organizer*



**5500**

Con vaschetta interna amovibile  
*With inner removable organizer*

## ARTICOLO / ARTICLE

	Larghezza Width	Profondità Depth	Altezza Height	Codice a barre Barcode
<b>5300</b>	220	175	150	8010693026708
<b>5400</b>	340	180	150	8010693026609
<b>5500</b>	392	210	188	8010693026401

## IMBALLO / PACKING

Pz. Pc.	Tipo Type	Larghezza Width	Profondità Depth	Altezza Height
10	cartone/carton	360	238	765
10	cartone/carton	365	355	765
10	cartone/carton	420	400	945

Tutte le misure sono espresse in millimetri / All measures are in millimeters

# > Linea VALENTINO

VALIGETTE PORTAUTENSILI

Tool boxes



**5540**

Con vaschetta interna amovibile  
With inner removable organizer



**5550**

Con vaschetta interna amovibile  
With inner removable organizer

## ARTICOLO / ARTICLE

	Larghezza Width	Profondità Depth	Altezza Height	Codice a barre Barcode
<b>5540</b>	450	238	195	8010693035205
<b>5550</b>	450	238	210	8010693027903

## IMBALLO / PACKING

Pz. Pc.	Tipo Type	Larghezza Width	Profondità Depth	Altezza Height
5	cartone/carton	460	248	995
5	cartone/carton	460	248	1070

Tutte le misure sono espresse in millimetri / All measures are in millimeters



prodotto in polipropilene  
produced in polypropylene



non assorbe gli odori  
odor-proof



non trattiene umidità  
doesn't retain humidity

Prodotto italiano ecosostenibile  
Eco-sustainable italian product



**5600**

Con vaschetta interna amovibile  
*With inner removable organizer*



**5700**

Con vaschetta interna amovibile  
*With inner removable organizer*



#### ARTICOLO / ARTICLE

	Larghezza Width	Profondità Depth	Altezza Height	Codice a barre Barcode
<b>5600</b>	500	268	230	8010693019809
<b>5700</b>	580	280	250	8010693027804

#### IMBALLO / PACKING

Pz. Pc.	Tipo Type	Larghezza Width	Profondità Depth	Altezza Height
5	cartone/carton	508	275	1166
4	cartone/carton	590	290	1010

Tutte le misure sono espresse in millimetri / All measures are in millimeters

# > Linea VALENTINO

VALIGETTE PORTAUTENSILI

*Tool boxes*

Vano porta-minuterie  
*Storage compartments*



Portapunte  
*Drill bits box*



## VALIGETTA PORTATRAPANO

*Drill holder case*

**2500**



Interno in gommapiuma  
*Internal foam*

### ARTICOLO / ARTICLE

Larghezza Width	Profondità Depth	Altezza Height	Codice a barre Barcode
400	340	133	8010693028009

**2500**

### IMBALLO / PACKING

Pz. Pz. Pc. Type	Tipo Type	Larghezza Width	Profondità Depth	Altezza Height
5	cartone/carton	405	345	670

Tutte le misure sono espresse in millimetri / All measures are in millimeters



prodotto in polipropilene  
produced in polypropylene



non assorbe gli odori  
odor-proof



non trattiene umidità  
doesn't retain humidity

Prodotto italiano ecosostenibile  
Eco-sustainable italian product



Interno senza gommapiuma

*Internal without foam*



### VALIGETTA PORTATRAPANO

*Drill holder case*

**2401**

Interno in gommapiuma

*Internal foam*



### VALIGETTA PORTATRAPANO

*Drill holder case*

**2411**



### VASCHETTA PORTATUTTO

*Storage tray*

**325**

#### ARTICOLO / ARTICLE

	Larghezza Width	Profondità Depth	Altezza Height	Codice a barre Barcode
<b>2401</b>	372	314	100	8010693016808
<b>2411</b>	372	314	100	8010693016907
<b>325</b>	378	251	162	8010693011902

#### IMBALLO / PACKING

Pz. Pc.	Tipo Type	Larghezza Width	Profondità Depth	Altezza Height
7	cartone/carton	383	320	710
7	cartone/carton	383	320	710
25	cartone/carton	385	265	530

Tutte le misure sono espresse in millimetri / All measures are in millimeters

# Linea **TEKNA**

## VALIGETTE PORTAUTENSILI

La linea di valigette Tekna è stata realizzata per uso soprattutto professionale. Il design è lineare, moderno e la fotoincisione, molto leggera, rende questi articoli gradevoli al tatto.

## TOOLS BOXES

*Tekna line is ideal for professional use. The design is modern and linear and photoengraving is light and smooth to the touch.*

Manico ad elsa studiato per proteggere la mano

*Hilt-handle studied to protect hands from any shock*

2 vani porta-minuteria con coperchio trasparente

*2 storage compartments with transparent lids*

2 ampi vani atti a contenere elettroutensili

*2 large compartments to store electric tools*

Vaschetta interna amovibile

*Removable tray*

Colori sobri, professionali e di forte impatto cromatico

*Sober and professional colors with a high chromatic impact*



# > Linea **TEKNA**

Prodotto italiano ecosostenibile  
Eco-sustainable italian product



prodotto in polipropilene  
produced in polypropylene



non assorbe gli odori  
odor-proof



non trattiene umidità  
doesn't retain humidity

Top di gamma della Linea Tekna, è una valigetta carrellata dotata di 2 ruote posteriori grandi e robuste con assale in acciaio per resistere al tempo e all'usura. È composta da 2 parti indipendenti e complementari che si possono utilizzare anche separatamente. La parte superiore è una valigetta portautensili, mentre il vano inferiore, molto capiente, è adatto per riporre gli elettroutensili; quest'ultimo sganciato dalla parte superiore può essere usato come sgabello.

*The top of Tekna Line is a mobile tool case with 2 large rear wheels and an iron axle to resist against wear and time. It consists of 2 independent but complementary parts, that you can also use separately: the upper part consists of a tool case, the lower part is very capacious, suitable for storing power tools and, once unhooked from the top, it becomes a comfortable and sturdy stool.*

## **VALIGETTA CARRELLATA**

*Mobile tool case*



**6700R**

### ARTICOLO / ARTICLE

Larghezza Width	Profondità Depth	Altezza Height	Codice a barre Barcode
<b>6700R</b> 460	280	665	8010693044207

### IMBALLO / PACKING

Pz. Pc.	Tipo Type	Larghezza Width	Profondità Depth	Altezza Height
2	cartone/carton	565	465	675

Tutte le misure sono espresse in millimetri / All measures are in millimeters

# > Linea **TEKNA**

VALIGETTE PORTAUTENSILI

*Tool boxes*

Con vaschetta interna amovibile

*With inner removable organizer*



**6300V**



**6500V**

## ARTICOLO / ARTICLE

	Larghezza Width	Profondità Depth	Altezza Height	Codice a barre Barcode
<b>6300V</b>	350	170	230	8010693048809
<b>6500V</b>	420	220	340	8010693048700

## IMBALLO / PACKING

Pz. Pc.	Tipo Type	Larghezza Width	Profondità Depth	Altezza Height
5	cartone/carton	360	183	1180
3	cartone/carton	430	229	1040

Tutte le misure sono espresse in millimetri / All measures are in millimeters





prodotto in polipropilene  
produced in polypropylene



non assorbe gli odori  
odor-proof



non trattiene umidità  
doesn't retain humidity

Prodotto italiano ecosostenibile  
Eco-sustainable italian product



**6700V**

**ARTICOLO / ARTICLE**

Larghezza Width	Profondità Depth	Altezza Height	Codice a barre Barcode
6700V 460	280	455	8010693046003

**IMBALLO / PACKING**

Pz. Pc.	Tipo Type	Larghezza Width	Profondità Depth	Altezza Height
2	cartone/carton	455	285	925

Tutte le misure sono espresse in millimetri / All measures are in millimeters

# Linea **PANNELLI**

## **PANNELLI E MENSOLE PORTAUTENSILI**

Prodotti in polipropilene, sono l'ideale per attrezzare le pareti di garage e luoghi di lavoro. Realizzati con plastica riciclata, riciclabili e conformi alla normativa REACH.

## **PANELS AND TOOL SHELVES**

*Produced with polypropylene, these items are fit for garages and workstations. Produced with recycling and recyclable plastic, in compliance with REACH regulation.*

Colori professionali e di forte impatto cromatico

*Professional colors with a high chromatic impact*

Resistenti e modulari  
*Resistant and modular*

Adatto a tutti i tipi di attrezzi  
*Suitable for all types of tools*

Immagine su due lati, packaging ingegnerizzato per contenere al minimo il volume del prodotto e i costi di trasporto

*Dual-front illustration, engineered packing to limit the volume of the products and then the freight costs*



# > Linea PANNELLI

Prodotto italiano ecosostenibile  
Eco-sustainable italian product



prodotto in polipropilene  
produced in polypropylene



non assorbe gli odori  
odor-proof



non trattiene umidità  
doesn't retain humidity



semplice sistema di assemblaggio  
easy assembly system



**320**



**319**



**322**

KIT composto da/consists of:  
Pannello/panel 323x17x385  
9 contenitori/containers art.101  
6 contenitori/containers art.102



**323**

KIT composto da/consists of:  
Pannello/panel 646x17x385  
18 contenitori/containers art.101  
12 contenitori/containers art.102

## ARTICOLO / ARTICLE

	Larghezza Width	Profondità Depth	Altezza Height	Codice a barre Barcode
<b>319</b>	495	213	50	8010693015405
<b>320</b>	615	140	39	8010693008100
<b>322</b>	323	180	385	8010693008308
<b>323</b>	646	180	385	8010693008407

## IMBALLO / PACKING

Pz. Pc.	Tipo Type	Larghezza Width	Profondità Depth	Altezza Height
12	cartone/carton	530	265	385
24	cartone/carton	520	245	615
12	cartone/carton	655	395	655
6	cartone/carton	655	395	655

Tutte le misure sono espresse in millimetri / All measures are in millimeters

# > Linea **PANNELLI**

## PANNELLI E MENSOLE PORTAUTENSILI

*Panels and tool shelves*

### 321

KIT composto da/consists of:

Pannello/panel 646x17x385

6 contenitori/containers art.101

1 mensola/shelf

19 ganci/hooks



### 324

KIT composto da/consists of:

Pannello/panel 646x17x385

19 ganci assortiti/assorted hooks

5 + 2 + 2 + 4 + 4 + 8 =

### 333/10

25 ganci assortiti/assorted hooks



#### ARTICOLO / ARTICLE

	Larghezza Width	Profondità Depth	Altezza Height	Codice a barre Barcode
<b>321</b>	646	140	385	8010693008209
<b>324</b>	646	17	385	8010693008506
<b>333/10</b>	155	250	25	8010693012602

#### IMBALLO / PACKING

Pz. Pc.	Tipo Type	Larghezza Width	Profondità Depth	Altezza Height
12	cartone/carton	655	395	655
30	cartone/carton	655	395	540
10	cartone/carton	203	206	250

Tutte le misure sono espresse in millimetri / All measures are in millimeters



prodotto in polipropilene  
produced in polypropylene



non assorbe gli odori  
odor-proof



non trattiene umidità  
doesn't retain humidity



semplice sistema di assemblaggio  
easy assembly system

Prodotto italiano ecosostenibile  
Eco-sustainable italian product



**332**

KIT composto da/consists of:  
2 pannelli/panels 500x500  
2 mensole/shelves  
50 ganci assortiti/assorted hooks

**330**

KIT composto da/consists of:  
2 pannelli/panels 500x500  
50 ganci assortiti/assorted hooks



ARTICOLO / ARTICLE

	Larghezza Width	Profondità Depth	Altezza Height	Codice a barre Barcode
<b>332</b>	1000	213	500	8010693018901
<b>330</b>	1000	20	500	8010693011803

IMBALLO / PACKING

Pz. Pc.	Tipo Type	Larghezza Width	Profondità Depth	Altezza Height
4	cartone/carton	340	510	510
6	cartone/carton	510	215	510

Tutte le misure sono espresse in millimetri / All measures are in millimeters

# > Linea PANNELLI

Prodotto italiano ecosostenibile  
Eco-sustainable italian product



## PANNELLI PORTA ATTREZZI DA PARETE

Panel tool holder wall



prodotto in polipropilene  
produced in polypropylene



non assorbe gli odori  
odor-proof



non trattiene umidità  
doesn't retain humidity



semplice sistema di assemblaggio  
easy assembly system



**326**

**KIT composto da:** / consists of:

- 4 Pannelli/panels 323x17x385
- 15 contenitori/containers art.101
- 12 contenitori/containers art.102
- 2 mensole/shelves
- 2 Portachiavi/key holder
- 38 ganci/hooks

**73**  
Pezzi/Pcs

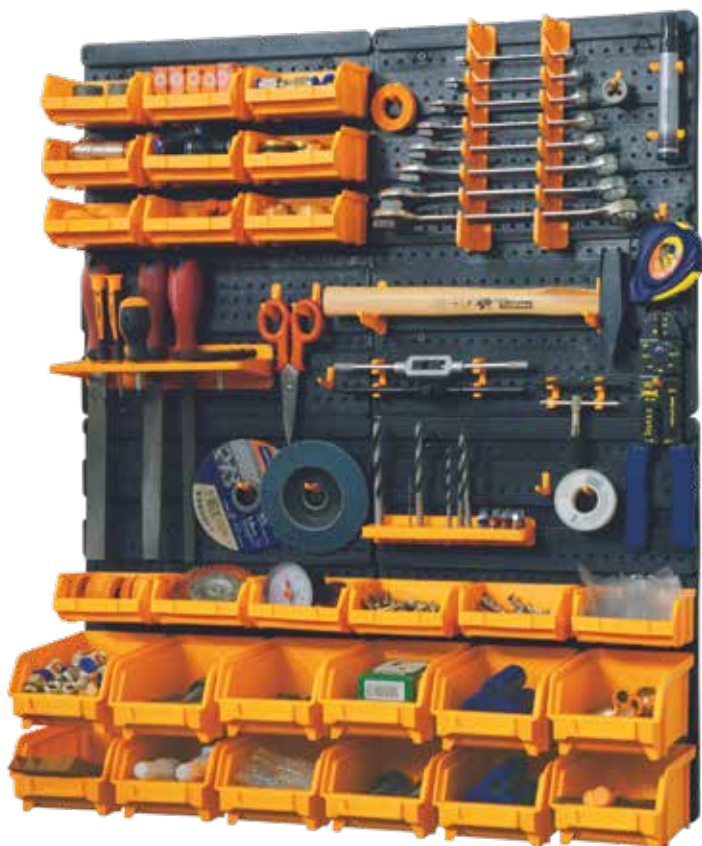

### ARTICOLO / ARTICLE

Larghezza Width	Profondità Depth	Altezza Height	Codice a barre Barcode
646	183	770	8010693126354

**326**

### IMBALLO / PACKING

Pz. Pc.	Tipo Type	Larghezza Width	Profondità Depth	Altezza Height
1	cartone/carton	390	144	655

Tutte le misure sono espresse in millimetri / All measures are in millimeters

Personalizzazioni possibili con minimo d'ordine da concordare.  
*Possible customizations with minimum order to be agreed.*

Prodotto italiano ecosostenibile  
Eco-sustainable italian product



## PANNELLI PORTA ATTREZZI DA PARETE

*Panel tool holder wall*

**KIT composto da:** / *consists of:*

- 3 Pannelli/panels 323x17x385
- 12 contenitori/containers art.101
- 2 mensole/shelfs
- 2 Portachiavi/key holder
- 19 ganci/hooks

**38**

**Pezzi/Pcs**



## PANNELLI PORTA ATTREZZI DA PARETE

*Panel tool holder wall*

**KIT composto da:** / *consists of:*

- Pannello/panel 500x20x500
- 5 contenitori/containers art.101
- 8 contenitori/containers art.102
- 2 mensole/shelfs
- 2 Portachiavi/key holder
- 25 ganci/hooks

**43**

**Pezzi/Pcs**

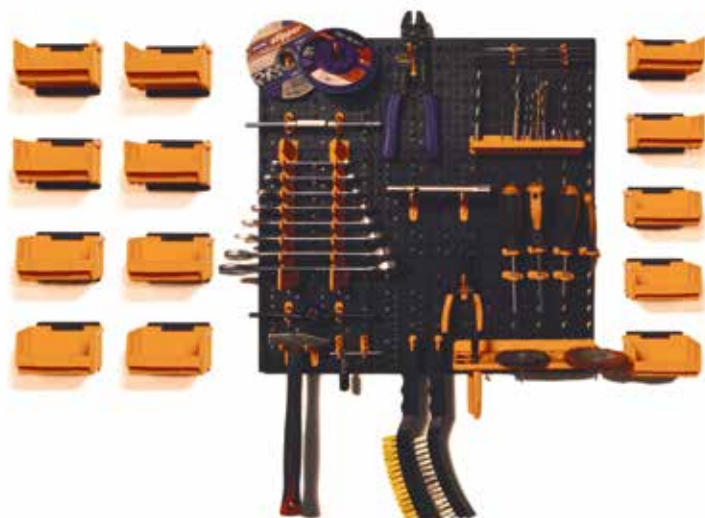

## PANNELLI PORTA ATTREZZI DA PARETE

*Panel tool holder wall*

**KIT composto da:** / *consists of:*

- 2 Pannelli/panels 500x20x500
- 5 contenitori/containers art.101
- 4 contenitori/containers art.102
- 2 mensole/shelfs
- 2 Portachiavi/key holder
- 50 ganci/hooks

**65**

**Pezzi/Pcs**

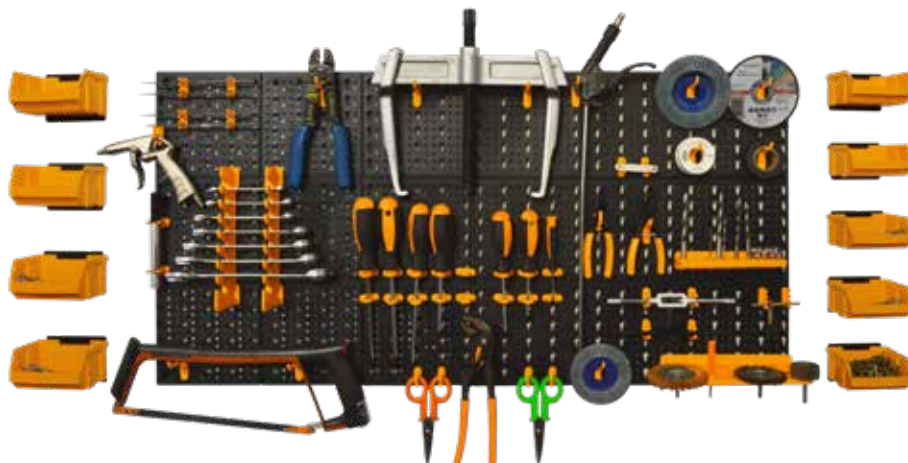

# Linea **VALENTINO**

## VASCHEE PORTAMINUTERIA

La gamma di vaschette portaminuteria (serie 2000, 3000 e 4000) offre un'ampia scelta di dimensioni e di versioni: con vaschette estraibili, con divisori fissi e rimovibili. Dotate di coperchi trasparenti antiurto.

## TOOL BOXES

*The range of tool trays (2000, 3000, and 4000 series) offers a wide choice of sizes and models. All the trays are equipped with antishock transparent lids. Available models with fixed and removable dividers and boxes inside.*



### Caratteristiche principali Main features

- L'esposizione risulta di ottimo impatto visivo  
*The layout has a strong visual impact*
- Prodotti in parte in polistirolo antiurto e in parte in polipropilene, antiurto, resistente al freddo, alle intemperie, agli oli e ai solventi  
*Produced with anti-shock polystyrene and with polypropylene material, weatherproof and resistant against solvents and oils*
- Prodotti anche con plastica riciclata, riciclabile e conforme alla normativa REACH  
*Produced with recycling an recyclable plastic, in compliance with REACH regulation*



# > Linea VALENTINO

Prodotto italiano ecosostenibile  
Eco-sustainable italian product



prodotto in polipropilene  
produced in polypropylene



non assorbe gli odori  
odor-proof



non trattiene umidità  
doesn't retain humidity



semplice sistema di assemblaggio  
easy assembly system



**3100**



**3100T**



**3100V**



**183**



**3200**



**3200T**



**3200V**



**184**

## ARTICOLO / ARTICLE

	Larghezza Width	Profondità Depth	Altezza Height	Codice a barre Barcode
<b>3100</b>	120	100	28	8010693017102
<b>3100T</b>	120	100	28	8010693045303
<b>3100V</b>	120	100	28	8010693045402
<b>3200</b>	180	128	32	8010693017201
<b>3200T</b>	180	128	32	8010693044504
<b>3200V</b>	180	128	32	8010693044702
<b>183</b>	37	21	23	8010693046508
<b>184</b>	39	31	25	8010693046508

## IMBALLO / PACKING

Pz. Pc.	Tipo Type	Larghezza Width	Profondità Depth	Altezza Height
28	cartone/carton	203	206	250
28	cartone/carton	203	206	250
28	cartone/carton	203	206	250
28	cartone/carton	225	259	366
28	cartone/carton	225	259	366
28	cartone/carton	225	259	366
20	cartone/carton	203	206	250
20	cartone/carton	203	206	250

Tutte le misure sono espresse in millimetri / All measures are in millimeters

# > Linea VALENTINO

SCATOLE PORTAMINUTERIA

Tool boxes



**3300**



**3300T**



**3300V**



**185**



**3350**



**3350T**

## ARTICOLO / ARTICLE

	Larghezza Width	Profondità Depth	Altezza Height	Codice a barre Barcode
<b>3300</b>	242	188	37	8010693017300
<b>3300T</b>	242	188	37	8010693044603
<b>3300V</b>	242	188	37	8010693044801
<b>3350</b>	242	188	60	8010693022205
<b>3350T</b>	242	188	60	8010693044306
<b>185</b>	54	39	31	8010693046607

## IMBALLO / PACKING

Pz. Pc.	Tipo Type	Larghezza Width	Profondità Depth	Altezza Height
28	cartone/carton	530	265	385
28	cartone/carton	530	265	385
28	cartone/carton	530	265	385
16	cartone/carton	530	265	385
16	cartone/carton	530	265	385
20	cartone/carton	203	206	250

Tutte le misure sono espresse in millimetri / All measures are in millimeters



prodotto in polipropilene  
produced in polypropylene



non assorbe gli odori  
odor-proof



non trattiene umidità  
doesn't retain humidity



semplice sistema di assemblaggio  
easy assembly system

Prodotto italiano ecosostenibile  
Eco-sustainable italian product



**3351**



**3351V**

**186**



**3400**



**3500**

ARTICOLO / ARTICLE

	Larghezza Width	Profondità Depth	Altezza Height	Codice a barre Barcode
<b>3351</b>	242	188	60	8010693026203
<b>3351V</b>	242	188	60	8010693044900
<b>3400</b>	360	252	64	8010693017409
<b>3500</b>	362	250	85	8010693019601
<b>186</b>	51	39	55	8010693046706

IMBALLO / PACKING

Pz. Pc.	Tipo Type	Larghezza Width	Profondità Depth	Altezza Height
16	cartone/carton	530	265	385
16	cartone/carton	530	265	385
8	cartone/carton	530	265	385
6	cartone/carton	530	265	385
20	cartone/carton	203	206	250

Tutte le misure sono espresse in millimetri / All measures are in millimeters

# > Linea **VALENTINO**

SCATOLE PORTAMINUTERIA

*Tool boxes*



**3600**



**3700**

## ARTICOLO / ARTICLE

	Larghezza Width	Profondità Depth	Altezza Height	Codice a barre Barcode
<b>3600</b>	443	317	80	8010693019700
<b>3700</b>	443	317	107	8010693025909

## IMBALLO / PACKING

Pz. Pc.	Tipo Type	Larghezza Width	Profondità Depth	Altezza Height
8	cartone/carton	640	331	455
6	cartone/carton	640	331	455

Tutte le misure sono espresse in millimetri / All measures are in millimeters



prodotto in polipropilene  
produced in polypropylene



non assorbe gli odori  
odor-proof



non trattiene umidità  
doesn't retain humidity



semplice sistema di assemblaggio  
easy assembly system

Prodotto italiano ecosostenibile  
Eco-sustainable italian product



**3713**



**193**



**194**



**195**



**3710**

### ARTICOLO / ARTICLE

	Larghezza Width	Profondità Depth	Altezza Height	Codice a barre Barcode
<b>3710</b>	443	317	107	8010693026500
<b>3713</b>	443	317	107	8010693027002
<b>193</b>	90	69	94	8010693027408
<b>194</b>	139	89	94	8010693027507
<b>195</b>	208	89	94	8010693027606

### IMBALLO / PACKING

Pz. Pc.	Tipo Type	Larghezza Width	Profondità Depth	Altezza Height
6	cartone/carton	640	331	455
6	cartone/carton	640	331	455
64	cartone/carton	225	259	366
88	cartone/carton	392	257	450
20	cartone/carton	203	206	250

Tutte le misure sono espresse in millimetri / All measures are in millimeters

# > Linea **VALENTINO**

SCATOLE PORTAMINUTERIA

*Tool boxes*



**4350**



**4400**



**4600**

## ARTICOLO / ARTICLE

	Larghezza Width	Profondità Depth	Altezza Height	Codice a barre Barcode
<b>4350</b>	242	188	120	8010693022304
<b>4400</b>	360	252	128	8010693020201
<b>4600</b>	443	317	160	8010693020300

## IMBALLO / PACKING

Pz. Pc.	Tipo Type	Larghezza Width	Profondità Depth	Altezza Height
8	cartone/carton	530	265	385
4	cartone/carton	530	265	385
4	cartone/carton	640	331	455

Tutte le misure sono espresse in millimetri / All measures are in millimeters



prodotto in polipropilene  
produced in polypropylene



non assorbe gli odori  
odor-proof



non trattiene umidità  
doesn't retain humidity



semplice sistema di assemblaggio  
easy assembly system

Prodotto italiano ecosostenibile  
Eco-sustainable italian product



### 3050

KIT composto da/consists of:

- 2 art. 3100
- 1 art. 3200
- 1 art. 3300



### 3060

KIT composto da/consists of:

- 2 art. 3100
- 1 art. 3200
- 1 art. 3300
- 1 art. 3400

#### ARTICOLO / ARTICLE

	Larghezza Width	Profondità Depth	Altezza Height	Codice a barre Barcode
<b>3050</b>	242	188	69	8010693025800
<b>3060</b>	360	252	100	8010693032600

#### IMBALLO / PACKING

Pz. Pc.	Tipo Type	Larghezza Width	Profondità Depth	Altezza Height
14	cartone/carton	530	265	385
5	cartone/carton	530	265	385

Tutte le misure sono espresse in millimetri / All measures are in millimeters

# > Linea VALENTINO

SCATOLE PORTAMINUTERIA

Tool boxes



**2201**



**2211**



**2311**



**187**



**188**



**189**

## ARTICOLO / ARTICLE

	Larghezza Width	Profondità Depth	Altezza Height	Codice a barre Barcode
<b>2201</b>	372	314	40	8010693016600
<b>2211</b>	372	314	40	8010693045501
<b>2311</b>	372	314	70	8010693016709
<b>187</b>	57	45	32	8010693046805
<b>188</b>	90	57	32	8010693046904
<b>189</b>	117	90	32	8010693047000

## IMBALLO / PACKING

Pz. Pc.	Tipo Type	Larghezza Width	Profondità Depth	Altezza Height
17	cartone/carton	710	320	383
17	cartone/carton	710	320	383
10	cartone/carton	710	320	383
20	cartone/carton	203	206	250
20	cartone/carton	203	206	250
20	cartone/carton	203	206	250

Tutte le misure sono espresse in millimetri / All measures are in millimeters



# > CONFEZIONAMENTO

Prodotto italiano ecosostenibile  
Eco-sustainable italian product



prodotto in polipropilene  
produced in polypropylene



non assorbe gli odori  
odor-proof



non trattiene umidità  
doesn't retain humidity



semplice sistema di assemblaggio  
easy assembly system



**150**



**160**

## ARTICOLO / ARTICLE

	Larghezza Width	Profondità Depth	Altezza Height	Codice a barre Barcode
<b>150</b>	46	2	124	8010693022700
<b>160</b>	70	2	163	8010693022601



**102C**



**103C**

## ARTICOLO / ARTICLE

	Larghezza Width	Profondità Depth	Altezza Height	Codice a barre Barcode
<b>102C</b>	103	166	73	8010693020508
<b>103C</b>	146	237	124	8010693020607

Tutte le misure sono espresse in millimetri / All measures are in millimeters

Linea  
**VARIOBOX**



**CASSETTIERE PORTAMINUTERIA**

La gamma di cassettiere portaminuteria offre un'ampia scelta di dimensioni e di versioni tutte con cassetti trasparenti.

**STORAGE UNITS**

*The range of storage units offers a wide choice of sizes and models. All the units are equipped with transparent drawers.*

# > Linea **VARIOBOX**

Prodotto italiano ecosostenibile  
Eco-sustainable italian product



## CASSETTIERE PORTAMINUTERIA

Storage units



prodotto in polistirolo  
produced in polystyrene



non assorbe gli odori  
odor-proof



non trattiene umidità  
doesn't retain humidity



semplice sistema di assemblaggio  
easy assembly system

SERIE

400

HARDWARE



**401**

6 cassetti trasparenti  
*6 transparent drawers*

Misura utile contenitore

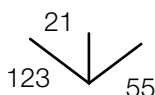

**411**

3 cassetti trasparenti  
*3 transparent drawers*

Misura utile contenitore

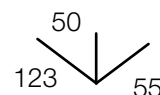

**412**

2 cassetti trasparenti  
*2 transparent drawers*

Misura utile contenitore

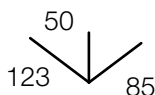

**414**

1 cassetto trasparente  
*1 transparent drawer*

Misura utile contenitore

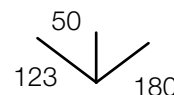

### ARTICOLO / ARTICLE

	Larghezza Width	Profondità Depth	Altezza Height	Codice a barre Barcode
<b>401</b>	192	148	63	8010693009008
<b>411</b>	192	148	63	8010693008704
<b>412</b>	192	148	63	8010693008803
<b>414</b>	192	148	63	8010693008902

### IMBALLO / PACKING

Pz. Pc.	Tipo Type	Larghezza Width	Profondità Depth	Altezza Height
24	cartone/carton	392	257	450
24	cartone/carton	392	257	450
24	cartone/carton	392	257	450
24	cartone/carton	392	257	450

Tutte le misure sono espresse in millimetri / All measures are in millimeters

# > Linea **VARIOBOX**

CASSETTIERE PORTAMINUTERIA

*Storage units*

SERIE

500



**501T**

24 cassetti trasparenti  
*24 transparent drawers*

Misura utile contenitore

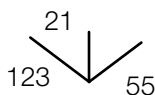

**511T**

12 cassetti trasparenti  
*2 transparent drawers*

Misura utile contenitore

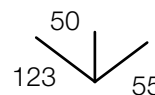

**512T**

8 cassetti trasparenti  
*8 transparent drawers*

Misura utile contenitore

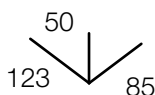

**514T**

4 cassetti trasparenti  
*4 transparent drawers*

Misura utile contenitore

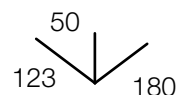

## ARTICOLO / ARTICLE

	Larghezza Width	Profondità Depth	Altezza Height	Codice a barre Barcode
<b>501T</b>	192	148	230	8010693001101
<b>511T</b>	192	148	230	8010693001408
<b>512T</b>	192	148	230	8010693001507
<b>514T</b>	192	148	230	8010693001606

## IMBALLO / PACKING

Pz. Pc.	Tipo Type	Larghezza Width	Profondità Depth	Altezza Height
8	cartone/carton	390	310	470
8	cartone/carton	390	310	470
8	cartone/carton	390	310	470
8	cartone/carton	390	310	470

Tutte le misure sono espresse in millimetri / All measures are in millimeters



prodotto in polistirolo  
produced in polystyrene



non assorbe gli odori  
odor-proof



non trattiene umidità  
doesn't retain humidity



semplice sistema di assemblaggio  
easy assembly system

Prodotto italiano ecosostenibile  
Eco-sustainable italian product



**SERIE**  
**600**

HARDWARE



**601T**

48 cassetti trasparenti  
48 transparent drawers

Misura utile contenitore

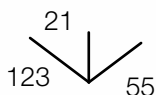

**611T**

24 cassetti trasparenti  
24 transparent drawers

Misura utile contenitore

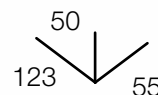

**612T**

16 cassetti trasparenti  
16 transparent drawers

Misura utile contenitore

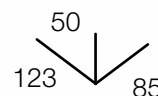

**ARTICOLO / ARTICLE**

	Larghezza Width	Profondità Depth	Altezza Height	Codice a barre Barcode
<b>601T</b>	382	148	230	8010693000401
<b>611T</b>	382	148	230	8010693000302
<b>612T</b>	382	148	230	8010693000609

**IMBALLO / PACKING**

Pz. Pc.	Tipo Type	Larghezza Width	Profondità Depth	Altezza Height
4	cartone/carton	390	310	470
4	cartone/carton	390	310	470
4	cartone/carton	390	310	470

Tutte le misure sono espresse in millimetri / All measures are in millimeters

# > Linea **VARIOBOX**

CASSETTIERE PORTAMINUTERIA

Storage units

SERIE

600



**613T**

12 cassetti trasparenti

12 transparent drawers



**614T**

8 cassetti trasparenti

8 transparent drawers

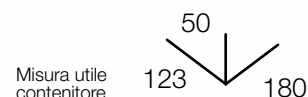

**615T**

4+4+4 cassetti trasparenti

4+4+4 transparent drawers

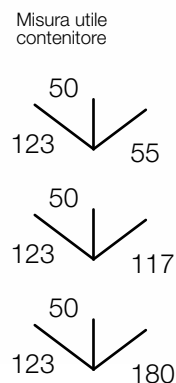

## ARTICOLO / ARTICLE

	Larghezza Width	Profondità Depth	Altezza Height	Codice a barre Barcode
<b>613T</b>	382	148	230	8010693003402
<b>614T</b>	382	148	230	8010693003501
<b>615T</b>	382	148	230	8010693000500

## IMBALLO / PACKING

Pz. Pc.	Tipo Type	Larghezza Width	Profondità Depth	Altezza Height
4	cartone/carton	390	310	470
4	cartone/carton	390	310	470
4	cartone/carton	390	310	470

Tutte le misure sono espresse in millimetri / All measures are in millimeters



prodotto in polistirolo  
produced in polystyrene



non assorbe gli odori  
odor-proof



non trattiene umidità  
doesn't retain humidity



semplice sistema di assemblaggio  
easy assembly system

Prodotto italiano ecosostenibile  
Eco-sustainable italian product



SERIE

700



**701T**

9 cassetti trasparenti  
*9 transparent drawers*

Misura utile contenitore

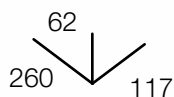

**702T**

6 cassetti trasparenti  
*6 transparent drawers*

Misura utile contenitore

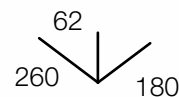

**703T**

3 cassetti trasparenti  
*3 transparent drawers*

Misura utile contenitore

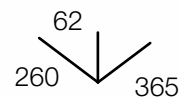

### ARTICOLO / ARTICLE

	Larghezza Width	Profondità Depth	Altezza Height	Codice a barre Barcode
<b>701T</b>	382	290	230	8010693000807
<b>702T</b>	382	290	230	8010693000708
<b>703T</b>	382	290	230	8010693000906

### IMBALLO / PACKING

Pz. Pc.	Tipo Type	Larghezza Width	Profondità Depth	Altezza Height
2	cartone/carton	390	310	470
2	cartone/carton	390	310	470
2	cartone/carton	390	310	470

Tutte le misure sono espresse in millimetri / All measures are in millimeters

# > Linea **VARIOBOX**

CASSETTIERE PORTAMINUTERIA

Storage units

SERIE

900

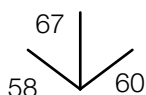

**901**

9 cassetti trasparenti / 9 transparent drawers

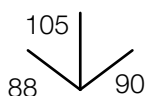

**904**

6 cassetti trasparenti / 6 transparent drawers

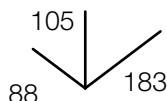

**905**

3 cassetti trasparenti / 3 transparent drawers

## ARTICOLO / ARTICLE

	Larghezza Width	Profondità Depth	Altezza Height	Codice a barre Barcode
<b>901</b>	576	60	77	8010693009305
<b>904</b>	576	94	116	8010693031009
<b>905</b>	576	94	116	8010693031108

## IMBALLO / PACKING

Pz. Pc.	Tipo Type	Larghezza Width	Profondità Depth	Altezza Height
10	cartone/carton	310	185	620
10	cartone/carton	615	220	620
10	cartone/carton	615	220	620

Tutte le misure sono espresse in millimetri / All measures are in millimeters





prodotto in polistirolo  
produced in polystyrene



non assorbe gli odori  
odor-proof



non trattiene umidità  
doesn't retain humidity



semplice sistema di assemblaggio  
easy assembly system

Prodotto italiano ecosostenibile  
Eco-sustainable italian product



SERIE

HOBBY

HARDWARE



**802**

16 cassetti trasparenti / 16 transparent drawers

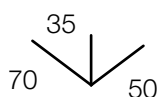

**HOBBY12**

12 cassetti trasparenti / 12 transparent drawers



**HOBBY15**

15 cassetti trasparenti / 15 transparent drawers

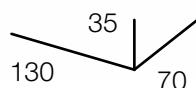

**HOBBY24**

24 cassetti trasparenti / 24 transparent drawers

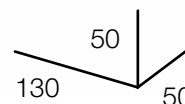

### ARTICOLO / ARTICLE

	Larghezza Width	Profondità Depth	Altezza Height	Codice a barre Barcode
<b>802</b>	221	85	156	8010693007400
<b>HOBBY12</b>	190	142	228	8010693007608
<b>HOBBY15</b>	228	140	190	8010693012008
<b>HOBBY24</b>	377	142	228	8010693007509

### IMBALLO / PACKING

Pz. Pc.	Tipo Type	Larghezza Width	Profondità Depth	Altezza Height
30	cartone/carton	456	260	806
16	cartone/carton	393	295	945
16	cartone/carton	393	295	945
8	cartone/carton	393	295	945

Tutte le misure sono espresse in millimetri / All measures are in millimeters

## Linea **CONTENITORI**

### **CONTENITORI PORTAMINUTERIA IN POLIPROPILENE ANTIURTO**

Prodotti eco-sostenibili in polipropilene, materiale flessibile e antiurto, sono impilabili e adatti per essere movimentati. Colore standard blu avio, ma sempre disponibili a magazzino anche in giallo, blu, verde, rosso.

#### **BINS UNITS IN ANTI-SHOCK POLYPROPYLENE**

These environmentally sustainable bins are produced in polypropylene, anti-shock flexible material. They are stackable and fit for movements and handling. Standard color is petrol blue but they are always available in yellow, blue, green, red.

#### **Caratteristiche principali Main features**

- Disponibili in 5 dimensioni  
*Available in 5 sizes*
- Dotati di porta cartellino  
*Card holder*
- Disponibili anche in kit con supporto per ancoraggio a parete e da terra  
*Available with wall supports and with floor structure, too*
- Prodotti in polipropilene, materiale antiurto, resistente al freddo, alle intemperie, agli oli e ai solventi  
*Produced in polypropylene, anti-shock material, weatherproof and resistant against solvents and oils*
- Prodotti con plastica riciclata, riciclabile e conforme alla normativa REACH  
*Produced with recycling an recyclable plastic, in compliance with REACH regulation*



# > Linea **CONTENITORI**

Prodotto italiano ecosostenibile  
Eco-sustainable italian product



prodotto in polipropilene  
produced in polypropylene



non assorbe gli odori  
odor-proof



non trattiene umidità  
doesn't retain humidity



semplice sistema di assemblaggio  
easy assembly system

LINEA / LINE

100



**101**



**102**



**103**



**105**



**104**

## ARTICOLO / ARTICLE

	Larghezza Width	Profondità Depth	Altezza Height	Codice a barre Barcode
<b>101</b>	100	95	50	8010693005208
<b>102</b>	103	166	73	8010693005307
<b>103</b>	146	237	124	8010693005406
<b>104</b>	205	335	149	8010693005505
<b>105</b>	305	480	177	8010693005604

## IMBALLO / PACKING

Pz. Pc.	Tipo Type	Larghezza Width	Profondità Depth	Altezza Height
70	cartone/carton	440	387	252
36	cartone/carton	440	387	252
24	cartone/carton	520	245	615
21	cartone/carton	1005	350	630
12	cartone/carton	1040	485	620

Tutte le misure sono espresse in millimetri / All measures are in millimeters

# > Linea **CONTENITORI**

CONTENITORI PORTAMINUTERIA IN POLIPROPILENE ANTIURTO

*Bins units in anti-shock polypropylene*

LINEA / LINE

200



**201**

KIT composto da / consists of:  
6 art. 101 + 1 art. 205



**211**

KIT composto da / consists of:  
6 art. 101 + 6 art. 211S



**202**

KIT composto da / consists of:  
6 art. 102 + 1 art. 205



**212**

KIT composto da / consists of:  
6 art. 102 + 6 art. 212S



**203**

KIT composto da  
consists of:  
4 art. 103 + 1 art. 205



**213**

KIT composto da / consists of:  
3 art. 103 + 3 art. 213S



**205**

## ARTICOLO / ARTICLE

	Larghezza Width	Profondità Depth	Altezza Height	Codice a barre Barcode
<b>201</b>	600	95	50	8010693005703
<b>202</b>	600	166	73	8010693005802
<b>203</b>	600	237	124	8010693005901
<b>205</b>	580	8	42	8010693025602
<b>211</b>	600	95	50	8010693012800
<b>212</b>	600	166	73	8010693012909
<b>213</b>	600	237	124	8010693013005

## IMBALLO / PACKING

Pz. Pc.	Tipo Type	Larghezza Width	Profondità Depth	Altezza Height
22	cartone/carton	520	245	615
9	cartone/carton	520	245	615
4	cartone/carton	520	245	615
20	cartone/carton	600	37	53
30	cartone/carton	520	245	615
12	cartone/carton	520	245	615
8	cartone/carton	520	245	615

Tutte le misure sono espresse in millimetri / All measures are in millimeters



prodotto in polipropilene  
produced in polypropylene



non assorbe gli odori  
odor-proof



non trattiene umidità  
doesn't retain humidity



semplice sistema di assemblaggio  
easy assembly system

Prodotto italiano ecosostenibile  
Eco-sustainable italian product



LINEA / LINE

300

HARDWARE



**303**

KIT composto da / consists of:  
24 art. 103



**302**

KIT composto da / consists of:  
72 art. 102



**305**

KIT composto da / consists of:  
36 art. 101 + 12 art. 102 + 8 art. 103

ARTICOLO / ARTICLE

	Larghezza Width	Profondità Depth	Altezza Height	Codice a barre Barcode
<b>302</b>	600	300	1250	8010693006007
<b>303</b>	600	300	1250	8010693006205
<b>305</b>	600	300	1250	8010693006403

IMBALLO / PACKING

Pz. Pc.	Tipo Type	Larghezza Width	Profondità Depth	Altezza Height
1	cartone/carton	470	165	1260
1	cartone/carton	470	165	1260
1	cartone/carton	470	165	1260

Tutte le misure sono espresse in millimetri / All measures are in millimeters

# Linea **UNIVERSAL BOX**

## **CONTENITORI PORTAMINUTERIA IN POLISTIROLO ANTIURTO**

Prodotti in polistirolo antiurto, adatti per realizzare robuste strutture autoportanti. Grazie al particolare sistema di incastro laterale, sono compatibili con i contenitori più diffusi sul mercato.

## **BINS UNITS IN ANTI-SHOCK POLYSTYRENE**

*These bins are produced in anti-shock polystyrene, fit to get steady and strong structure. Thanks to aside connecting system, they are linkable to the most popular bins on the market.*

## **Caratteristiche principali Main features**

- Disponibili in 5 dimensioni  
*Available in 5 sizes*
- Dotati di porta cartellino  
*Card holder*
- Sovrapponibili e auto agganciati  
*Stackable and linkable, thanks to aside connecting system*
- I contenitori più grandi sono dotati di impugnatura posteriore per una presa ottimale  
*The bigger bins have a back handle for a good catching*
- Prodotti in polistirolo antiurto, materiale rigido e tenace, che garantisce una portata elevata  
*Produced with anti-shock polystyrene, a stiff and strong material, that guarantees a high bearing capacity*
- Prodotti con plastica riciclata, riciclabile e conforme alla normativa REACH  
*Produced with recycling an recyclable plastic, in compliance with REACH regulation*



# > Linea **UNIVERSAL BOX**

Prodotto italiano ecosostenibile  
Eco-sustainable italian product



prodotto in polistirolo  
produced in polystyrene



non assorbe gli odori  
odor-proof



non trattiene umidità  
doesn't retain humidity



semplice sistema di assemblaggio  
easy assembly system

LINEA / LINE

**UNIVERSAL BOX**

HARDWARE



**A2**



**B3**



**D4**



**F6**



**E5**

## ARTICOLO / ARTICLE

	Larghezza Width	Profondità Depth	Altezza Height	Codice a barre Barcode
<b>A2</b>	110	160	76	8010693012107
<b>B3</b>	150	240	125	8010693012206
<b>D4</b>	212	360	165	8010693012305
<b>E5</b>	313	504	190	8010693012404
<b>F6</b>	380	610	250	8010693043606

## IMBALLO / PACKING

Pz. Pc.	Tipo Type	Larghezza Width	Profondità Depth	Altezza Height
60	cartone/carton	520	245	615
24	cartone/carton	520	245	615
21	cartone/carton	1120	375	655
12	cartone/carton	1055	505	625
1	sfuso/bulk	380	610	250

Tutte le misure sono espresse in millimetri / All measures are in millimeters

  
**NOVITÀ**  
New product

**NUOVO PRODOTTO  
IN ARRIVO**



## Professional smallware storage



**MADIA**

 Safety Lock

 **RECYCLED  
PLASTIC**

### Caratteristiche principali

*Main features*

- Disponibili in 4 dimensioni  
*Available in 4 sizes*
- Sovrapponibili e auto agganciati  
*Stackable and linkable, thanks to  
aside connecting system*
- Dotati di porta cartellino  
*Card holder*
- Prodotti con plastica riciclata  
*Produced with recycling plastic*
- Fissaggio a parete  
*Wall Fixed*
- Chiusura di sicurezza  
*Safety lock*



# > Linea **MADIA**

Prodotto italiano ecosostenibile  
Eco-sustainable italian product



SCAFFALI MODULARI PORTAMINUTERIA  
*Modular shelves units*



**NOVITÀ**  
*New product*

Armadi costruiti in lamiera elettrosaldata con barre d1 rinforzo e corredato di pannelli scorrevoli su cuscinetti a sfera. verniciato a forno con polvere epossidica di colore Antracite RAL 7016. Questo armadio è progettato in maniera tale da rendere agevole e veloce l'assemblaggio direttamente nel luogo di utilizzo. I carrelli vengono forniti smontati con schema di montaggio e viteria di assemblaggio

*Cabinets made of electrowelded sheet and reinforcement bars, feature panels sliding on roller bearings; RAL 7016 Anthracite epoxy powder-painted The cabinet has been designed in a way that facilitates the assembly on site. The product is supplied disassembled, with the assembly schema and screws*

**DISPONIBILI CON PROFONDITÀ DA**

*Available with depth from*  
400mm / 600mm



**RAL  
7016**

**PANNELLO  
SCORREVOLE**  
*Sliding Panel*

**175 Kg  
MAX**

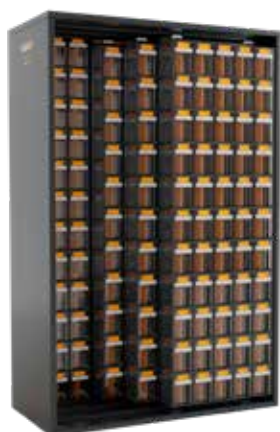

# Linea **ALEDAN**

## SCAFFALI MODULARI PORTAMINUTERIE

La Linea Aledan propone una serie di armadi e mobiletti, articoli che abbinano plastica e metallo creando una perfetta simbiosi.

## MODULAR SHELVES SMALL PARTS

*Aledan Line suggests a great value range series of cabinets and cup-boards, combining plastic with metal, the result is a perfect harmony.*

### SERIE 1100

Strutture a giorno con contenitori in polipropilene, materiale antiurto. Utilissimi nei magazzini dove occorre movimentare i contenitori e il loro contenuto. A differenza degli scaffali tradizionali, queste strutture accolgono i contenitori evitando di perdere spazio in altezza, in larghezza e profondità. I contenitori non poggiano su ripiani, ma su tubi, per una maggiore capacità di carico.

### 1100 SERIES

*They have bins in polypropylene, anti-shock material. They are very useful for warehouses where you have to move the bins and their contents. These frames contain the bins without losing space in height, width and depth. The bins don't rest on shelves but on tubes for a higher loading capacity.*

#### Caratteristiche principali Main features

- Strutture in lamiera robusta e resistente con spessore 16/10  
*Robust and resistant metal frame with a thickness of 16/10*
- Completi di contenitori a bocca di lupo per una rapida movimentazione  
*With bins for rapid movements*
- I mobili con contenitori di varie taglie, hanno la stessa altezza, vengono spesso affiancati, varia solo la profondità  
*The cabinets of different sizes, have the same height and you can place them side by side, they change only in depth*
- Prodotti con plastica riciclata, riciclabile e conforme alla normativa REACH  
*Produced with recycling and recyclable plastic, in compliance with REACH regulation*



# > Linea **ALEDAN**

Prodotto italiano ecosostenibile  
Eco-sustainable italian product



prodotto in polipropilene  
produced in polypropylene



non assorbe gli odori  
odor-proof



non trattiene umidità  
doesn't retain humidity



semplice sistema di assemblaggio  
easy assembly system

SERIE

**1100**



**1102/95**

**1102/95GI**

Con 54 contenitori art.102 / With 54 bins art.102



**1103/95**

**1103/95GI**

Con 24 contenitori art.103 / With 24 bins art.103



**1104/95**

**1104/95GI**

Con 15 contenitori art.104 / With 15 bins art.104



**1105/95**

**1105/95GI**

Con 8 contenitori art.105 / With 8 bins art.105

● Disponibile in blu avio, in altri colori su richiesta / Available in petrol blue, other colors on demand

## ARTICOLO / ARTICLE

	Larghezza Width	Profondità Depth	Altezza Height	Codice a barre Barcode
<b>1102/95</b>	678	195	950	8010693038305
<b>1103/95</b>	640	255	950	8010693038404
<b>1104/95</b>	658	370	950	8010693038503
<b>1105/95</b>	660	490	950	8010693038602

## IMBALLO / PACKING

Pz. Pc.	Tipo Type	Larghezza Width	Profondità Depth	Altezza Height
1	cartone/carton	698	210	970
1	cartone/carton	296	656	970
1	cartone/carton	675	405	970
1	cartone/carton	670	555	970

Tutte le misure sono espresse in millimetri / All measures are in millimeters

# > Linea **ALEDAN**

SCAFFALI MODULARI PORTAMINUTERIA

*Modular shelves units*

SERIE

1100



● **1102**

● **1102GI**

+ 114 contenitori / *bins art.102*

● **1103**

● **1103GI**

+ 48 contenitori / *bins art.103*

● Disponibile in blu avio, in altri colori su richiesta / *Available in petrol blue, other colors on demand*

## ARTICOLO / ARTICLE

	Larghezza Width	Profondità Depth	Altezza Height	Codice a barre Barcode
<b>1102</b>	678	● 206	1900	8010693038206
<b>1103</b>	640	● 255	1900	8010693030507

## IMBALLO / PACKING

Pz. Pc.	Tipo Type	Larghezza Width	Profondità Depth	Altezza Height
1	cartone/carton	235	697	1925
1	cartone/carton	300	660	1925

Tutte le misure sono espresse in millimetri / All measures are in millimeters



prodotto in polipropilene  
produced in polypropylene



non assorbe gli odori  
odor-proof



non trattiene umidità  
doesn't retain humidity



semplice sistema di assemblaggio  
easy assembly system

Prodotto italiano ecosostenibile  
Eco-sustainable italian product



SERIE

1100



● **1104**

● **1104GI**

+ 30 contenitori / bins art.104

● **1105**

● **1105GI**

+ 18 contenitori / bins art.105

● Disponibile in blu avio, in altri colori su richiesta / Available in petrol blue, other colors on demand

### ARTICOLO / ARTICLE

	Larghezza Width	Profondità Depth	Altezza Height	Codice a barre Barcode
<b>1104</b>	658	● 370	1900	8010693033409
<b>1105</b>	660	● 490	1900	8010693033508

### IMBALLO / PACKING

Pz. Pc.	Tipo Type	Larghezza Width	Profondità Depth	Altezza Height
1	cartone/carton	407	675	1925
1	cartone/carton	550	677	1925

Tutte le misure sono espresse in millimetri / All measures are in millimeters

# > Linea **ALEDAN**

SCAFFALI MODULARI PORTAMINUTERIA AD ANTE SCORREVOLI

*Modular shelves units with sliding doors*

SERIE

60



## SERIE 60 - 120

Armadi ad ante scorrevoli con cassetti trasparenti e basculanti in 2 dimensioni diverse. Nuovo sistema di supporto del cassetto per una perfetta apertura ed estraibilità. Con imballo robusto, ogni mobile viene fornito su bancale pronto per essere inoltrato al Cliente finale.

### 60 - 120 SERIES

*Sliding door cabinets with transparent and tilt drawers in 2 different sizes. New drawer support system for perfect opening and removal. With sturdy packaging, each piece of furniture is supplied on a pallet ready to be forwarded to the end customer.*

### Caratteristiche principali

#### Main features

- Strutture in lamiera robusta e resistente con spessore 16/10  
*Robust and resistant metal frame with a thickness of 16/10*
- Cassetti in K-Resin, materiale particolarmente elastico, antiurto e trasparente che consente una perfetta visione del contenuto  
*K-Resin drawers, a very elastic and anti-shock material for a perfect view of the contents*
- Prodotti con plastica riciclata, riciclabile e conforme alla normativa REACH  
*Produced with recycling and recyclable plastic, in compliance with REACH regulation*

### ALEDAN 60/24

+ 24 cassetti / *drawers* 183x161x218

### ARTICOLO / ARTICLE

### IMBALLO / PACKING

	Larghezza Width	Profondità Depth	Altezza Height	Codice a barre Barcode	Pz. Pc.	Tipo Type	Larghezza Width	Profondità Depth	Altezza Height
<b>ALEDAN 60/24</b>	640	170	1900	8010693023301	1	cartone/carton	180	650	1950

Tutte le misure sono espresse in millimetri / All measures are in millimeters



prodotto in polipropilene  
produced in polypropylene



non assorbe gli odori  
odor-proof



non trattiene umidità  
doesn't retain humidity



semplice sistema di assemblaggio  
easy assembly system

Prodotto italiano ecosostenibile  
Eco-sustainable italian product



SERIE

120

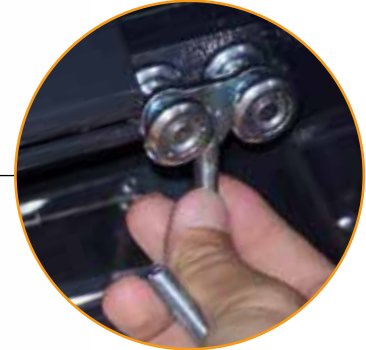

Guide in acciaio di spessore 3 mm e doppio carrello ad alta portata.

*3 mm thickness rails high load bearing capacity.*

HARDWARE

### ALEDAN 120

- + 90 cassetti / *drawers* 90x88x105
- + 30 cassetti / *drawers* 183x88x105
- + 48 cassetti / *drawers* 183x161x218

### ARTICOLO / ARTICLE

Larghezza Width	Profondità Depth	Altezza Height	Codice a barre Barcode
<b>ALEDAN 120</b> 1300	400	1900	8010693023004

### IMBALLO / PACKING

Pz. Pc.	Tipo Type	Larghezza Width	Profondità Depth	Altezza Height
1	cartone/carton	1325	535	2050

Tutte le misure sono espresse in millimetri / All measures are in millimeters

# > Linea **ALEDAN**

MOBILETTI CON VALIGETTA E CONTENITORI

*Cupboards with tool cases and bins*

SERIE

1400



**1400**

Con 4 valigette art. 3600

*With 4 tool cases art. 3600*



**1410**

Con 3 valigette art. 3710

*With 3 tool cases art. 3710*



Chiusura inclusa

*Lock included*

SERIE 1400 - 1500

Adatti per tutti i lavoratori che devono avere a disposizione molti utensili. Contengono valigette capienti con maniglia a scomparsa, coperchio trasparente e contenitori a bocca di lupo.

*1400 - 1500 SERIES*

*Suitable for all workers who need a lot of tools. They contain capacious tool cases with foldaway handles, transparent lids and bins.*

## Caratteristiche principali Main features

- Versatilità, in particolare la serie 1500  
*Versatility, especially the 1500 series*
- Ideali per attrezzare automezzi di lavoro in quanto le chiusure assicurano le valigette al mobiletto evitandone la fuoriuscita  
*Right solution to equip Van as the lock secures cases to the structure, to prevent movement and avoiding that they come out*
- Utilizzabili come banco da lavoro, aggiungendo e fissando un ripiano alle robuste strutture  
*You can use them as a work bench, adding and fixing a shelf on the robust frame*
- Predisposti per l'inserimento di 4 ruote alla base, diventano maneggevoli, sempre a portata di mano  
*Prepared for fixing 4 wheels to the base, they become manageable so they are always at hand*

### ARTICOLO / ARTICLE

	Larghezza Width	Profondità Depth	Altezza Height	Codice a barre Barcode
<b>1400</b>	490	388	340	8010693038800
<b>1410</b>	490	388	340	8010693038909

### IMBALLO / PACKING

Pz. Pc.	Tipo Type	Larghezza Width	Profondità Depth	Altezza Height
1	cartone/carton	338	345	495
1	cartone/carton	338	345	495

Tutte le misure sono espresse in millimetri / All measures are in millimeters





prodotto in polipropilene  
produced in polypropylene



non assorbe gli odori  
odor-proof



non trattiene umidità  
doesn't retain humidity



semplice sistema di assemblaggio  
easy assembly system

Prodotto italiano ecosostenibile  
Eco-sustainable italian product



SERIE

1500



**1500**

Con 4 valigette art. 3600  
e 3 valigette art. 3710

*With 4 organizers art. 3600  
and 3 organizers art. 3710*



**1520**

Con 6 valigette art. 3710

*With 6 organizers art. 3710*



**1510**

Con 8 valigette art. 3600

*With 8 organizers art. 3600*

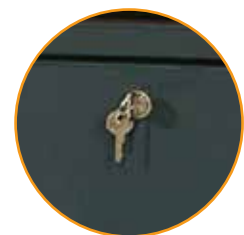
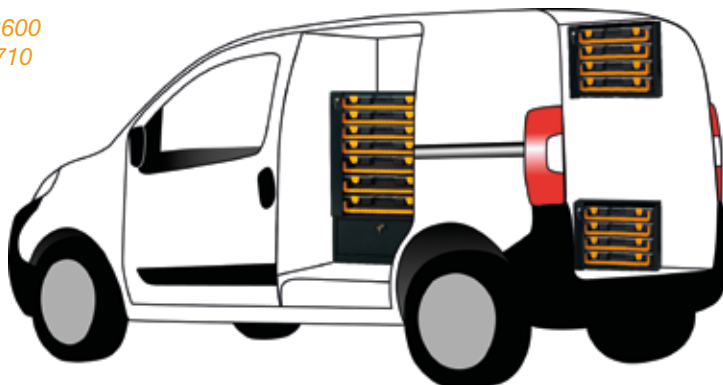

2 Chiusure incluse

*2 Locks included*

### ARTICOLO / ARTICLE

	Larghezza Width	Profondità Depth	Altezza Height	Codice a barre Barcode
<b>1500</b>	490	340	990	8010693029808
<b>1510</b>	490	340	990	8010693029907
<b>1520</b>	490	340	990	8010693030002

### IMBALLO / PACKING

Pz. Pc.	Tipo Type	Larghezza Width	Profondità Depth	Altezza Height
1	cartone/carton	495	345	990
1	cartone/carton	495	345	990
1	cartone/carton	495	345	990

Tutte le misure sono espresse in millimetri / All measures are in millimeters

# > Linea **ALEDAN**

SCAFFALI MODULARI PORTAMINUTERIA

*Modular shelves units*

LINEA / LINE

1100



● **1102/80VGI**

● **1102/80V**

Con 36 contenitori art.102

*With 36 bins art.102*

● **1103/80VGI**

● **1103/80V**

Con 16 contenitori art.103

*With 16 bins art.103*



● **1104/80VGI**

● **1104/80V**

Con 9 contenitori art.104

*With 9 bins art.104*

● Disponibile in blu avio, in altri colori su richiesta / Available in petrol blue, other colors on demand

## ARTICOLO / ARTICLE

	Larghezza Width	Profondità Depth	Altezza Height	Codice a barre Barcode
<b>1102/80V</b>	640	● 187	800	8010693045006
<b>1103/80V</b>	603	● 247	800	8010693045105
<b>1104/80V</b>	622	● 347	800	8010693045204

## IMBALLO / PACKING

Pz. Pc.	Tipo Type	Larghezza Width	Profondità Depth	Altezza Height
1	cartone/carton	200	661	815
1	cartone/carton	260	618	815
1	cartone/carton	340	645	815

Tutte le misure sono espresse in millimetri / All measures are in millimeters



prodotto in polipropilene  
produced in polypropylene



non assorbe gli odori  
odor-proof



non trattiene umidità  
doesn't retain humidity



semplice sistema di assemblaggio  
easy assembly system

Prodotto italiano ecosostenibile  
Eco-sustainable italian product



SERIE  
**1300**

SERIE  
**1800**

Maniglia di presa  
*Carry handle*



● **1300GI**  
● **1300**



Pannelli in metallo  
*Metal panels*



● **1350GI**  
● **1350**



Ruote in acciaio  
*Steel wheels*

● **1850GI**  
● **1850**

Struttura in metallo  
*Metal structure*

+ 36 contenitori / bins art.101  
+ 54 contenitori / bins art.102  
+ 36 contenitori / bins art.103

● Disponibile in blu avio, in altri colori su richiesta / Available in petrol blue, other colors on demand

ARTICOLO / ARTICLE

	Larghezza Width	Profondità Depth	Altezza Height	Codice a barre Barcode
<b>1300</b>	500	15	500	8010693052301
<b>1350</b>	1000	15	500	8010693052400
<b>1850</b>	1100	700	1430	8010693052707

IMBALLO / PACKING

Pz. Pc.	Tipo Type	Larghezza Width	Profondità Depth	Altezza Height
2	cartone/carton	530	530	35
2	cartone/carton	1020	530	35
1	cartone/carton	1325	630	335

Tutte le misure sono espresse in millimetri / All measures are in millimeters

NEW! NEW! NEW! NEW! NEW!

## Linea **TROLLEY- SHOP**



**Scritte, colori e  
posizionamento delle  
etichette personalizzabili.  
Customizable lettering,  
colors and placement of  
labels.**



prodotto in polipropilene  
produced in polypropylene



non assorbe gli odori  
odor-proof



non trattiene umidità  
doesn't retain humidity



semplice sistema di assemblaggio  
easy assembly system

**60Kg**  
**43 L**



Maniglia ergonomica rinforzata  
*Ergonomic reinforced handle*

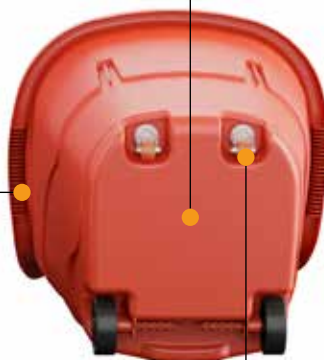

Ruota piroettante con cuffia metallica  
*Swivel wheel with metal cap*



Perno in nylon rinforzato con robusta ruota in PP-copo  
*Reinforced nylon pin with sturdy PP-copo wheel*



## SHOPRO

### ARTICOLO / ARTICLE

Larghezza Width	Profondità Depth	Altezza Height	Codice a barre Barcode
485	575	875	8010693125036

### IMBALLO / PACKING

Pz. Pc.	Tipo Type	Larghezza Width	Profondità Depth	Altezza Height
68	bancale/pallet	100	120	240

Tutte le misure sono espresse in millimetri / All measures are in millimeters

# Linea **EUROBOX**

I contenitori della linea Eurobox sono resistenti, impilabili, facili da pulire e modulari. Perfetti in cameretta o nel ripostiglio per contenere giochi, vestiti o utensili. È possibile personalizzare confezioni industriali di utensili o piccola attrezzatura che richieda protezione.

*The containers of the Eurobox line are resistant, stackable, easy to clean and modular. Perfect in the bedroom or in the closet to hold toys, clothes or utensils. It is possible to customize industrial tool packages or small equipment that requires protection.*

**EUROBOX**  
MODULAR SYSTEM



**MODULARITÀ:  
TUTTI I CONTENITORI SONO  
IMPILABILI PER RISPARMIARE  
SPAZIO**

*Modularity: all the boxes are stackable to save space*



# > Linea **EUROBOX**

Prodotto italiano ecosostenibile  
Eco-sustainable italian product



## CONTENITORI MODULARI IMPILABILI

*Modular stackable container*



prodotto in polipropilene  
produced in polypropylene



non assorbe gli odori  
odor-proof



non trattiene umidità  
doesn't retain humidity



per uso alimentare  
for food use

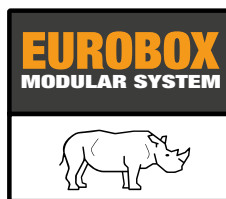

HARDWARE



**EN201507GC**

**1 LITRO**  
Litres



**EN201512GC**

**2 LITRI**  
Litres



**EN201517GC**

**3 LITRI**  
Litres



### ARTICOLO / ARTICLE

	Larghezza Width	Profondità Depth	Altezza Height	Codice a barre Barcode
<b>EN201507GC</b>	200	150	70	8010693121403
<b>EN201512GC</b>	200	150	120	8010693121410
<b>EN201517GC</b>	200	150	170	8010693121427

### IMBALLO / PACKING

Pz. Pc.	Tipo Type	Larghezza Width	Profondità Depth	Altezza Height
1	sfuso/bulk	200	150	70
1	sfuso/bulk	200	150	120
1	sfuso/bulk	200	150	170

Tutte le misure sono espresse in millimetri / All measures are in millimeters

# > Linea **EUROBOX**

CONTENITORI MODULARI IMPILABILI

*Modular stackable container*



prodotto in polipropilene  
produced in polypropylene



non assorbe gli odori  
odor-proof



non trattiene umidità  
doesn't retain humidity



per uso alimentare  
for food use

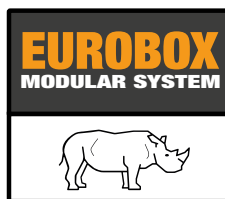

**EN302007GC**

**3** LITRI  
Litres



**EN302012GC**

**5** LITRI  
Litres



**EN302017GC**

**7** LITRI  
Litres

## ARTICOLO / ARTICLE

	Larghezza Width	Profondità Depth	Altezza Height	Codice a barre Barcode
<b>EN302007GC</b>	300	200	70	8010693121250
<b>EN302012GC</b>	300	200	120	8010693121267
<b>EN302017GC</b>	300	200	170	8010693121274

## IMBALLO / PACKING

Pz. Pc.	Tipo Type	Larghezza Width	Profondità Depth	Altezza Height
1	sfuso/bulk	300	200	70
1	sfuso/bulk	300	200	120
1	sfuso/bulk	300	200	170

Tutte le misure sono espresse in millimetri / All measures are in millimeters





Prodotto italiano ecosostenibile  
Eco-sustainable italian product



**OGNI CONTENITORE PUÒ ESSERE RICHIUDIBILE CON COPERCHIO**

*Each container can be closed with a lid*



**EN403022GC**

**20** LITRI  
Litres



**EN604012GC**

**24** LITRI  
Litres



#### ARTICOLO / ARTICLE

	Larghezza Width	Profondità Depth	Altezza Height	Codice a barre Barcode
<b>EN403022GC</b>	400	300	220	8010693120956
<b>EN604012GC</b>	600	400	120	8010693119745

#### IMBALLO / PACKING

Pz. Pc.	Tipo Type	Larghezza Width	Profondità Depth	Altezza Height
1	sfuso/bulk	400	300	220
1	sfuso/bulk	600	400	120

Tutte le misure sono espresse in millimetri / All measures are in millimeters

# > Linea **EUROBOX**

CONTENITORI MODULARI IMPILABILI

*Modular stackable container*



prodotto in polipropilene  
produced in polypropylene



non assorbe gli odori  
odor-proof



non trattiene umidità  
doesn't retain humidity



per uso alimentare  
for food use

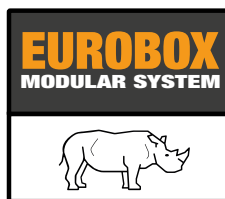

**EN604022GC**

**44** LITRI  
Litres 



**EN604032GC**

**65** LITRI  
Litres 

## ARTICOLO / ARTICLE

	Larghezza Width	Profondità Depth	Altezza Height	Codice a barre Barcode
<b>EN604022GC</b>	600	400	220	8010693119752
<b>EN604032GC</b>	600	400	320	8010693119769

## IMBALLO / PACKING

Pz. Pc.	Tipo Type	Larghezza Width	Profondità Depth	Altezza Height
1	sfuso/bulk	600	400	220
1	sfuso/bulk	600	400	320

Tutte le misure sono espresse in millimetri / All measures are in millimeters



Prodotto italiano ecosostenibile  
Eco-sustainable italian product



## OGNI CONTENITORE PUÒ ESSERE RICHIUDIBILE CON COPERCHIO

*Each container can be closed with a lid*



Coperchio con cerniere e chiusure realizzate in materiale tecnopolimero POM

*Lid with hinges and closures made of POM technopolymer material*



**ENC4030CGC**



**ENC6040CGC**



**ENC6040SGC**



**ENC4030SGC**



**ENC3020SGC**



**ENC2015SGC**

### ARTICOLO / ARTICLE

### IMBALLO / PACKING

	Larghezza Width	Profondità Depth	Altezza Height	Codice a barre Barcode
<b>ENC2015SGC</b>	200	150	23	8010693121441
<b>ENC3020SGC</b>	300	200	23	8010693121434
<b>ENC4030CGC</b>	400	300	23	8010693121076
<b>ENC4030SGC</b>	400	300	23	8010693121069
<b>ENC6040CGC</b>	600	400	23	8010693121113
<b>ENC6040SGC</b>	600	400	23	8010693121106

Pz. Pc.	Tipo Type	Larghezza Width	Profondità Depth	Altezza Height
10	film termoretrato/ shrinked film	200	150	150
10	film termoretrato/ shrinked film	300	200	150
10	film termoretrato/ shrinked film	400	300	150
10	film termoretrato/ shrinked film	400	300	150
10	film termoretrato/ shrinked film	600	400	150
10	film termoretrato/ shrinked film	600	400	150

Tutte le misure sono espresse in millimetri / All measures are in millimeters

# > Linea **EUROBOX**

KIT PER IMPILABILITÀ CARRELLINO

*Kit for stacking dolly*

con 4 ruote / *with 4 wheels*



Portata statica testata da:  
*Static load test by:*



Fori predisposti per viti M8  
per personalizzazioni

*Holes prepared for M8 screws  
for customization*

Struttura rinforzata da  
nervature robuste

*Structure reinforced by sturdy  
ribs*

Viti M8

*M8 screws*

Kit ruote  
opzionali LR2

*Optional  
wheels kit*



Aggancio  
universale  
contenitori/  
carrellino

*Universal joint  
Eurobox/dolly*

Sistema Anti-Torsione

*No-Torsion System*



**L5838N4A**

## ARTICOLO / ARTICLE

Larghezza Width	Profondità Depth	Altezza Height	Codice a barre Barcode
<b>L5838N4A</b> 605	400	150	8010693119981

## IMBALLO / PACKING

Pz. Pc.	Tipo Type	Larghezza Width	Profondità Depth	Altezza Height
3	cartone/carton	399	199	660

Tutte le misure sono espresse in millimetri / All measures are in millimeters

Prodotto italiano ecosostenibile  
Eco-sustainable italian product

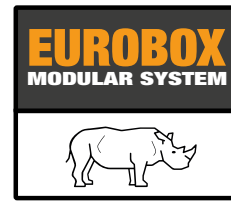

**L5838N4A**

Carrellino per la linea Eurobox

*Dolly for Eurobox Line*

# > Linea **EUROBOX**

CONTENITORI MODULARI IMPILABILI

*Modular stackable container*



prodotto in polipropilene  
produced in polypropylene



non assorbe gli odori  
odor-proof



non trattiene umidità  
doesn't retain humidity



per uso alimentare  
for food use

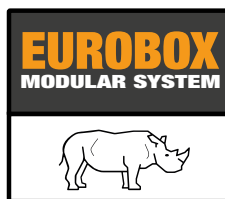

**EN604012DGC**

**24** LITRI  
Litres



**EN604022DGC**

**44** LITRI  
Litres

## ARTICOLO / ARTICLE

## IMBALLO / PACKING

	Larghezza Width	Profondità Depth	Altezza Height	Codice a barre Barcode
<b>EN604012DGC</b>	600	400	120	8010693119837
<b>EN604022DGC</b>	600	400	220	8010693119844

Pz. Pc.	Tipo Type	Larghezza Width	Profondità Depth	Altezza Height
1	sfuso/bulk	600	400	120
1	sfuso/bulk	600	400	220

Tutte le misure sono espresse in millimetri / All measures are in millimeters



Prodotto italiano ecosostenibile  
Eco-sustainable italian product



**OGNI CONTENITORE PUÒ ESSERE RICHIUDIBILE CON COPERCHIO**

*Each container can be closed with a lid*



**EN403022DGC**

**20** LITRI  
Litres



**EN604032DGC**

**65** LITRI  
Litres



**ARTICOLO / ARTICLE**

**IMBALLO / PACKING**

	Larghezza Width	Profondità Depth	Altezza Height	Codice a barre Barcode
<b>EN604032DGC</b>	600	400	320	8010693119851
<b>EN403022DGC</b>	400	300	220	8010693120949

Pz. Pc.	Tipo Type	Larghezza Width	Profondità Depth	Altezza Height
1	sfuso/bulk	600	400	320
1	sfuso/bulk	400	300	220

Tutte le misure sono espresse in millimetri / All measures are in millimeters

# Linea **STORE**

I contenitori della linea Store sono resistenti, impilabili, facili da pulire e modulari. Perfetti in cameretta o nel ripostiglio per contenere giochi, vestiti o utensili. È possibile personalizzare confezioni industriali di utensili o piccola attrezzatura che richieda protezione.

*The containers of the Store line are resistant, stackable, easy to clean and modular. Perfect in the bedroom or in the closet to hold toys, clothes or utensils. It is possible to customize industrial tool packages or small equipment that requires protection.*

**EUROBOX**  
MODULAR SYSTEM



**MODULARITÀ:  
TUTTI I CONTENITORI SONO  
IMPILABILI PER RISPARMIARE  
SPAZIO**

*Modularity: all the boxes are stackable to save space*





# > Linea **STORE**

Prodotto italiano ecosostenibile  
Eco-sustainable italian product



## CONTENITORI MODULARI IMPILABILI

*Modular stackable container*



prodotto in polipropilene  
produced in polypropylene



non assorbe gli odori  
odor-proof



non trattiene umidità  
doesn't retain humidity



per uso alimentare  
for food use

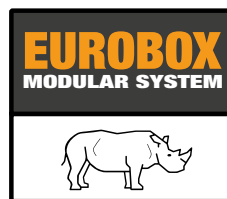

**EN201517BGC**



**EN302017BGC**



**EN403022BGC**

### ARTICOLO / ARTICLE

	Larghezza Width	Profondità Depth	Altezza Height	Codice a barre Barcode
<b>EN201517BGC</b>	200	150	170	8010693123827
<b>EN302017BGC</b>	300	200	170	8010693123926
<b>EN403022BGC</b>	400	300	220	8010693123650

### IMBALLO / PACKING

Pz. Pc.	Tipo Type	Larghezza Width	Profondità Depth	Altezza Height
1	sfuso/bulk	200	150	170
1	sfuso/bulk	300	200	170
1	sfuso/bulk	400	300	220

Tutte le misure sono espresse in millimetri / All measures are in millimeters

# Linea **STORE**

I contenitori della linea Store sono resistenti, impilabili, facili da pulire e modulari. Perfetti in cameretta o nel ripostiglio per contenere giochi, vestiti o utensili. È possibile personalizzare confezioni industriali di utensili o piccola attrezzatura che richieda protezione.

*The containers of the Store line are resistant, stackable, easy to clean and modular. Perfect in the bedroom or in the closet to hold toys, clothes or utensils. It is possible to customize industrial tool packages or small equipment that requires protection.*

**EUROBOX**  
MODULAR SYSTEM



**MODULARITÀ:  
TUTTI I CONTENITORI SONO  
IMPILABILI PER RISPARMIARE  
SPAZIO**

*Modularity: all the boxes are stackable to save space*



# > Linea **STORE**

Prodotto italiano ecosostenibile  
Eco-sustainable italian product



## CONTENITORI MODULARI IMPILABILI

*Modular stackable container*



prodotto in polipropilene  
produced in polypropylene



non assorbe gli odori  
odor-proof



non trattiene umidità  
doesn't retain humidity



per uso alimentare  
for food use

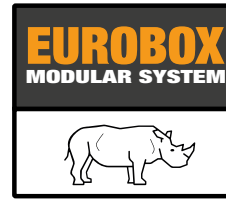

**EN201517BT**



**EN302017BT**



**EN403022BT**

### ARTICOLO / ARTICLE

### IMBALLO / PACKING

	Larghezza Width	Profondità Depth	Altezza Height	Codice a barre Barcode
<b>EN201517BT</b>	200	150	170	8010693123834
<b>EN302017BT</b>	300	200	170	8010693123957
<b>EN403022BT</b>	400	300	220	8010693123582
<b>EN604032BT</b>	600	400	320	8010693124898

Pz. Pc.	Tipo Type	Larghezza Width	Profondità Depth	Altezza Height
1	sfuso/bulk	200	150	170
1	sfuso/bulk	300	200	170
1	sfuso/bulk	400	300	220
1	sfuso/bulk	600	400	320

Tutte le misure sono espresse in millimetri / All measures are in millimeters

# Linea FIBRA

## Caratteristiche principali Main features

- Manici robusti e resistenti sia alle basse che alle alte temperature  
*Robust handles, resistant against low and high temperatures*
- Durata anche 10 volte superiore ai tradizionali manici in legno  
*Long duration, more than 10 times in comparison with the traditional wooden handle*
- Prodotti con un unico tipo di materiale, quindi riciclabile al 100% e conforme alla normativa REACH  
*Produced with a material only, 100% recyclable, in compliance with REACH regulation*



prodotto in nylon  
produced in nylon



non assorbe gli odori  
odor-proof



non trattiene umidità  
doesn't retain humidity



**Manici garantiti 10 anni**  
**Prodotti in nylon rinforzato**

*Handles guaranteed for 10 years Reinforced nylon products*

**30028**

**40045**

**40050**

**40058**



Utensili in metallo non compresi  
*Metal tools not included*

### ARTICOLO / ARTICLE

	Larghezza Width	∅ ∅	∅ inf. ∅ inf.	Codice a barre Barcode
<b>30028</b>	280	40	26	8010693028801
<b>40045</b>	450	35	25	8010693028900
<b>40050</b>	500	35	25	8010693029006
<b>40058</b>	580	35	25	8010693029105

### IMBALLO / PACKING

Pz. Pc.	Tipo Type	Larghezza Width	Profondità Depth	Altezza Height
10	sacchetto/plastic bag	70	160	280
10	sacchetto/plastic bag	50	160	450
10	sacchetto/plastic bag	50	160	500
10	sacchetto/plastic bag	50	180	580

Tutte le misure sono espresse in millimetri / All measures are in millimeters

# > Linea **FIBRA**

Prodotto italiano ecosostenibile  
Eco-sustainable italian product



HARDWARE



**30100**



**20100**



Utensili in metallo non compresi  
Metal tools not included



**Manici garantiti  
10 anni  
Prodotti in nylon  
rinforzato**

*Handles guaranteed  
for 10 years Reinforced  
nylon products*



**10120**



**10140**

## ARTICOLO / ARTICLE

	Larghezza Width	∅ ∅	∅ inf. ∅ inf.	Codice a barre Barcode
<b>20100</b>	1000	55	40	8010693028603
<b>30100</b>	1000	40	26	8010693028702
<b>10120</b>	1200	35		8010693028504
<b>10140</b>	1400	35		8010693028108

## IMBALLO / PACKING

Pz. Pc.	Tipo Type	Larghezza Width	Profondità Depth	Altezza Height
5	cartone/carton	60	160	1000
5	cartone/carton	60	160	1000
10	sacchetto/plastic bag	70	180	1200
5	cartone/carton	70	180	1420

Tutte le misure sono espresse in millimetri / All measures are in millimeters

# Linea **PICK**

## **BANCALI IN PLASTICA**

I bancali in plastica della Linea Pick, disponibili in 7 diverse varianti, sono una soluzione ottimale per il trasporto di ogni tipo di merce. Oltre ad essere più economici di quelli in legno, non necessitano di alcun tipo di certificazione per la loro esportazione, sono quindi sdoganabili in qualsiasi Stato.

## **PLASTIC PALLETS**

*Pick Line plastic pallet are an optima solution for the transport of all kinds of goods. They are available in 5 different variants. Plastic pallets are cheaper than wooden pallets and do not require any kind of certification for their export.*

**Superficie alleggerita extra resistente,  
costante e senza alterazioni**

*Surface lightened extra strong,  
constant and unaltered*

**Bordo rialzato anticaduta  
opzionale o integrato**

*Fall raised edge optional  
or built*

**Prelevabile anche  
da impianto**

*Liftable also when  
stacked*

# > Linea PICK

Prodotto italiano ecosostenibile  
Eco-sustainable italian product



prodotto in  
polipropilene  
produced in  
polypropylene



non assorbe  
gli odori  
odor-proof



non trattiene  
umidità  
doesn't retain  
humidity



semplice sistema  
di assemblaggio  
easy assembly  
system

## PICK2

CODICE A BARRE  
BARCODE

8010693119257



Impilabile  
*Stackable*

## PICK3

CODICE A BARRE  
BARCODE

8010693114733



## PICK5

CODICE A BARRE  
BARCODE

8010693099702



Superficie costante senza alterazioni  
*Constant height surface*

# > Linea **PICK**

## BANCALI IN PLASTICA

*Plastic pallets*

**PICK2**

### CARATTERISTICHE TECNICHE

Dimensioni (LxPxH)	400x600x120 mm
Altezza inforamento	100 mm
Spessore del piano	24 mm
Peso netto	1,55 Kg
N. pallet per pila	168
Altezza pila	1200 mm
Peso pila	260 Kg
Portata statica	200 Kg
Portata statica con PICK TR	225 Kg
Portata dinamica	100 Kg

### TECHNICAL FEATURES

Dimensions (LxPxH)	15,7x23,6x4,7 in
Pick height	3,9 in
Frame thickness	1,4 in
Net weight	3,4 lbs
N. pallet per stack	168
Stack height	47,2 in
Stack weight	573,2 lbs
Static load bearing capacity	441 lbs
Static load bearing capacity with PICK TR	496 lbs
Dynamic load bearing capacity	220,5 lbs

**PICK3**

### CARATTERISTICHE TECNICHE

Dimensioni (LxPxH)	600x800x155 mm
Altezza inforamento	105 mm
Spessore del piano	40 mm
Peso netto	4,75 Kg
N. pallet per pila	62
Altezza pila	1200 mm
Peso pila	295 Kg
Portata statica	500 Kg
Portata statica con PICK TR	550 Kg
Portata dinamica	250 Kg

### TECHNICAL FEATURES

Dimensions (LxPxH)	31,5x24x5,5 in
Pick height	4,1 in
Frame thickness	1,6 in
Net weight	10,5 lbs
N. pallet per stack	62
Stack height	47,2 in
Stack weight	650,4 lbs
Static load bearing capacity	1102,3 lbs
Static load bearing capacity with PICK TR	1212,5 lbs
Dynamic load bearing capacity	551,2 lbs

**PICK5**

### CARATTERISTICHE TECNICHE

Dimensioni (LxPxH)	1200x800x140 mm
Altezza inforamento	105 mm
Spessore del piano	35 mm
Peso netto	4,5 Kg
N. pallet per pila	65
Altezza pila	2500 mm
Peso pila	293 Kg
Portata statica	800 Kg
Portata statica con PICK TR	900 Kg
Portata dinamica	600 Kg

### TECHNICAL FEATURES

Dimensions (LxPxH)	47,3x31,5x5,5 in
Pick height	3,9 in
Frame thickness	1,3 in
Net weight	9,9 lbs
N. pallet per stack	65
Stack height	98,5 in
Stack weight	646 lbs
Static load bearing capacity	1763,7 lbs
Static load bearing capacity with PICK TR	1984,2 lbs
Dynamic load bearing capacity	1320 lbs

\* Con temperatura superiore a 50° i valori indicati potrebbero variare sino al 30%

*With a temperature exceeding 50° the indicated values may vary up to 30%*





prodotto in polipropilene  
produced in polypropylene



non assorbe gli odori  
odor-proof



non trattiene umidità  
doesn't retain humidity



semplice sistema di assemblaggio  
easy assembly system

Prodotto italiano ecosostenibile  
Eco-sustainable italian product



## PICK6

CODICE A BARRE  
BARCODE

8010693100323



Bordo rialzato anticaduta integrato

*Integrated fall-arrester edges*



Superficie costante senza alterazioni

*Constant height surface*

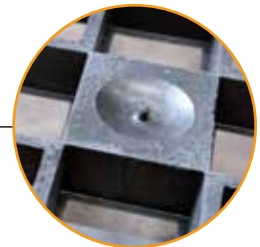

## PICK8

CODICE A BARRE  
BARCODE

8010693099801



Bordo rialzato anticaduta integrato

*Integrated fall-arrester edges*

# > Linea **PICK**

BANCALI IN PLASTICA

*Plastic pallets*

**PICK6**

## CARATTERISTICHE TECNICHE

Dimensioni (LxPxH)	1200x800x140 mm
Altezza inforcaemento	105 mm
Spessore del piano	35 mm
Peso netto	4,5 Kg
N. pallet per pila	65
Altezza pila	2500 mm
Peso pila	293 Kg
Portata statica	800 Kg
Portata statica con PICK TR	900 Kg
Portata dinamica	600 Kg

## TECHNICAL FEATURES

Dimensions (LxPxH)	47,3x31,5x5,5 in
Pick height	3,9 in
Frame thickness	1,3 in
Net weight	9,9 lbs
N. pallet per stack	65
Stack height	98,5 in
Stack weight	646 lbs
Static load bearing capacity	1763,7 lbs
Static load bearing capacity with PICK TR	1984,2 lbs
Dynamic load bearing capacity	1320 lbs

**PICK8**

## CARATTERISTICHE TECNICHE

Dimensioni (LxPxH)	1200x800x140 mm
Altezza inforcaemento	105 mm
Spessore del piano	35 mm
Peso netto	8,2 Kg
N. pallet per pila	65
Altezza pila	2500 mm
Peso pila	533 Kg
Portata statica	3600 Kg
Portata statica con PICK TR	4000 Kg
Portata dinamica	1200 Kg

## TECHNICAL FEATURES

Dimensions (LxPxH)	47,3x31,5x5,5 in
Pick height	3,9 in
Frame thickness	1,3 in
Net weight	22,5 lbs
N. pallet per stack	65
Stack height	98,5 in
Stack weight	1461,6 lbs
Static load bearing capacity	7936,6 lbs
Static load bearing capacity with PICK TR	8818,5 lbs
Dynamic load bearing capacity	2645,5 lbs

\* Con temperatura superiore a 50° i valori indicati potrebbero variare sino al 30%

*With a temperature exceeding 50° the indicated values may vary up to 30%*



prodotto in polipropilene  
produced in polypropylene



non assorbe gli odori  
odor-proof



non trattiene umidità  
doesn't retain humidity



semplice sistema di assemblaggio  
easy assembly system

Prodotto italiano ecosostenibile  
Eco-sustainable italian product



Superficie costante senza alterazioni  
*Constant height surface*

## PICK9

CODICE A BARRE  
BARCODE

8010693114740



Bordo rialzato anticaduta integrato

*Integrated fall-arrester edges*

## PICK10

CODICE A BARRE  
BARCODE

8010693100330



Sistema anticaduta integrato

*Integrated fall-arrester system*

Superficie costante senza alterazioni  
*Constant height surface*

# > Linea **PICK**

BANCALI IN PLASTICA

*Plastic pallets*

**PICK9**

## CARATTERISTICHE TECNICHE

Dimensioni (LxPxH)	1000x1200x145 mm
Altezza inforcaamento	108 mm
Spessore del piano	38 mm
Peso netto	7,2 Kg
N. pallet per pila	52
Altezza pila	2520 mm
Peso pila	375 Kg
Portata statica	1500 Kg
Portata dinamica	750 Kg

## TECHNICAL FEATURES

Dimensions (LxPxH)	39,3x47,2x5,7 in
Pick height	4,2 in
Frame thickness	1,5 in
Net weight	15,9 lbs
N. pallet per stack	52
Stack height	99,2 in
Stack weight	826,7 lbs
Static load bearing capacity	3306,9 lbs
Dynamic load bearing capacity	1653,5 lbs

**PICK10**

## CARATTERISTICHE TECNICHE

Dimensioni (LxPxH)	1000x1200x140 mm
Altezza inforcaamento	105 mm
Spessore del piano	35 mm
Peso netto	10,2 Kg
N. pallet per pila	65
Altezza pila	2500 mm
Peso pila	663 Kg
Portata statica	3600 Kg
Portata statica con PICK TR	4000 Kg
Portata dinamica	1200 Kg

## TECHNICAL FEATURES

Dimensions (LxPxH)	39,3x47,2x5,5 in
Pick height	3,9 in
Frame thickness	1,3 in
Net weight	22,5 lbs
N. pallet per stack	65
Stack height	98,5 in
Stack weight	1461,6 lbs
Static load bearing capacity	7936,6 lbs
Static load bearing capacity with PICK TR	8818,5 lbs
Dynamic load bearing capacity	2645,5 lbs

\* Con temperatura superiore a 50° i valori indicati potrebbero variare sino al 30%

*With a temperature exceeding 50° the indicated values may vary up to 30%*



prodotto in polipropilene  
produced in polypropylene



non assorbe gli odori  
odor-proof



non trattiene umidità  
doesn't retain humidity



semplice sistema di assemblaggio  
easy assembly system

Prodotto italiano ecosostenibile  
Eco-sustainable italian product



## PICKTR/3

CODICE A BARRE  
BARCODE

8010693099900

**15%**

Aumenta la portata di circa il 15%

*Increase about 15% load bearing capacity*

Kit 3 traverse  
*3 crossbars Kit*

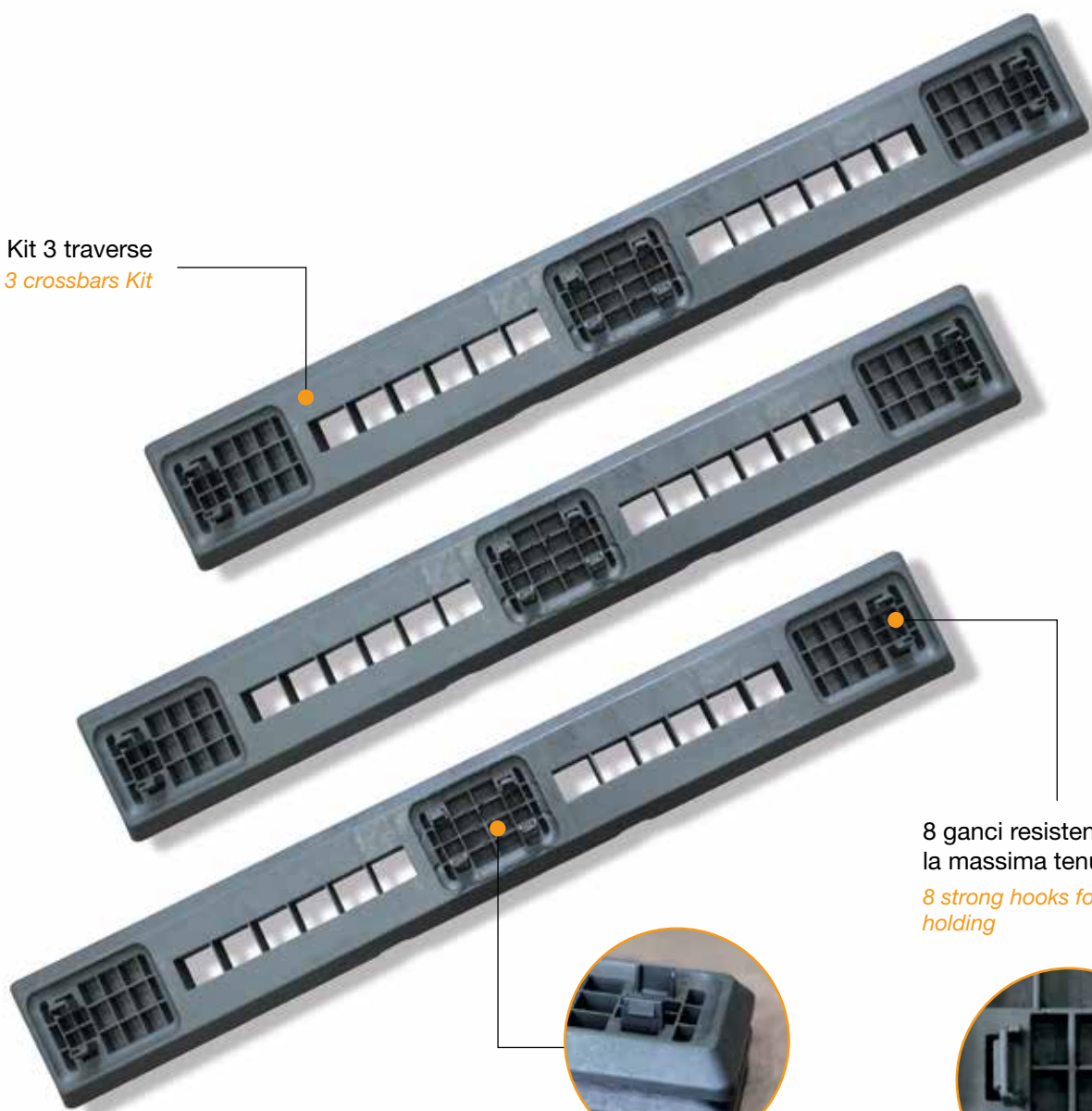

8 ganci resistenti per la massima tenuta

*8 strong hooks for maximum holding*



Smontabili e impilabili  
*Removable and stackable*



### CARATTERISTICHE TECNICHE

Dimensioni (LxPxH)	1000x130x42 mm
Peso netto	0,92 Kg

### TECHNICAL FEATURES

Dimensions (LxPxH)	39,4x5,1x1,6 in
Net weight	2 lbs

Linea  
**PICK**

**SUPER  
PICK** 

**Il più forte della categoria**  
*The strongest in the category*



# > SUPER-PICK

Prodotto italiano ecosostenibile  
Eco-sustainable italian product



## BANCALI IN PLASTICA

Plastic pallets



prodotto in polipropilene  
produced in polypropylene



non assorbe gli odori  
odor-proof



non trattiene umidità  
doesn't retain humidity



semplice sistema di assemblaggio  
easy assembly system

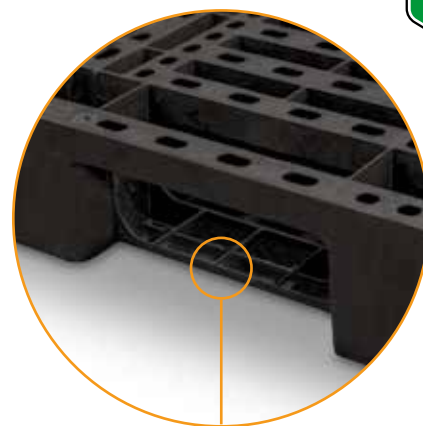

Slitte incorporate che rendono il bancale 30% più resistente

*Built-in slides make the pallet 30% more durable*

## PICKSUP5

CODICE A BARRE  
BARCODE

8010693125968

Dotato di piano antiscivolo

*Equipped with non-slip surface*

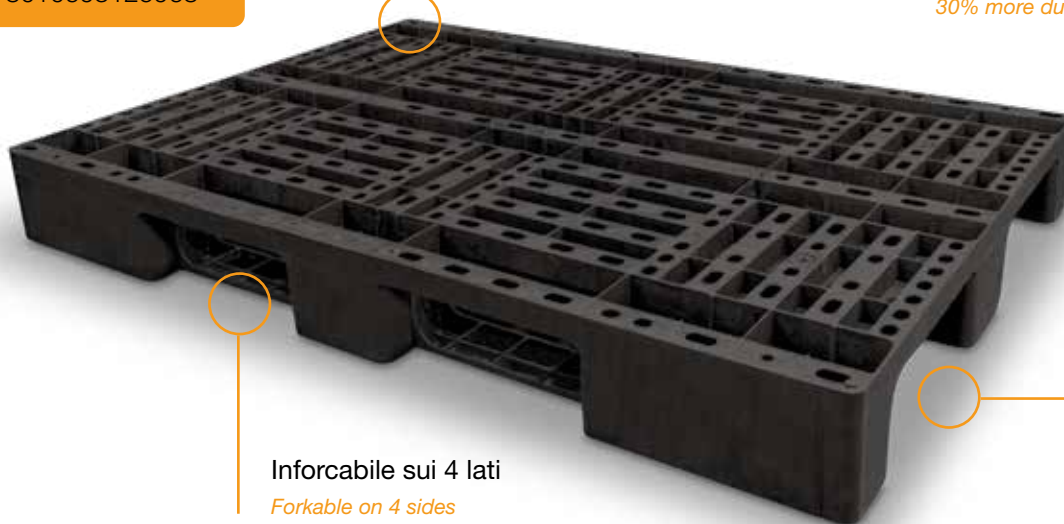

Inforcabile con Transpallet su 2 lati

*Forkable with Transpallet on 2 sides*

Inforcabile sui 4 lati

*Forkable on 4 sides*

### Caratteristiche principali

Leggero

Unico nel suo genere, perfetto per bancali a perdere tradizionali manici in legno

Stampato in resine riciclate

Posizionabile sui rack con portata fino a 200 Kg

Non necessita di fumigazione

Resistente all'umido e stoccabile all'aperto

### Main features

Light

*One of a kind, perfect for disposable pallets*

*Printed in recycled resins*

*Can be placed on racks with a load capacity of up to 200 kg*

*No need for fumigation*

*Moisture resistant and can be stored outdoors*

### CARATTERISTICHE TECNICHE

Dimensioni (LxPxH)	1200x800x120 mm
Altezza inforcamento	90 mm
Spessore del piano	27 mm
Peso netto	7,45 Kg
N. pallet per pila	20
Altezza pila	2400 mm <small>Misura base pila (LxP) 1200x940 mm</small>
Peso pila	140 Kg
Portata sui rack	200 Kg
Portata statica	2000 Kg
Portata dinamica	1000 Kg

### TECHNICAL FEATURES

Dimensions (LxPxH)	47,2x31,5x4,7 in
Pick height	3,5 in
Frame thickness	1,06 in
Net weight	16,424 lbs
N. pallet per stack	20
Stack height	94,5 in
Stack weight	308,6 lbs
Rackable up to	441 lbs
Static load bearing capacity	4409,2 lbs
Dynamic load bearing capacity	2204,6 lbs

PICKSUP5

Tutte le misure sono espresse in millimetri / All measures are in millimeters

Linea  
**VOYAGER**





# > VOYAGER

Prodotto italiano ecosostenibile  
Eco-sustainable italian product



prodotto in polipropilene  
produced in polypropylene



non assorbe gli odori  
odor-proof



non trattiene umidità  
doesn't retain humidity



semplice sistema di assemblaggio  
easy assembly system

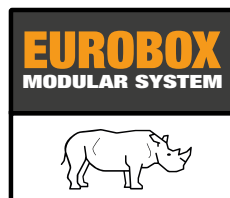

**V604032GC**

Il rimorchio per bicicletta Dolly Voyager è un accessorio multiuso capace di trasportare pesi notevoli. Un dispositivo versatile utile per tutte le necessità, è molto apprezzato da chi è appassionato di viaggi in bici e anche da chi fa consegne a domicilio.

*The Dolly Voyager bicycle trailer is a multi-purpose accessory capable of carrying heavy weights. A versatile device useful for all hobbies so it is also highly appreciated by those who dedicate themselves to traveling and those who distribute newspapers at home.*

Dotato di un telaio in acciaio verniciato che conferisce grande stabilità alla struttura, consta di un contenitore Eurobox, da carico standard, sul quale è possibile impilare altri moduli extra di diverse dimensioni per aumentare lo spazio di carico. Facilmente estraibile, è realizzato in materiale polipropilene, riciclabile e antiurto.

*Equipped with a painted steel frame that gives great stability to the structure, which consists of a standard cargo container on which it is possible to stack other modules of different sizes. Easily removable, it is made of polypropylene material, recyclable and shockproof.*

## ARTICOLO / ARTICLE

Larghezza Width	Profondità Depth	Altezza Height	Codice a barre Barcode
V604032GC 1200	500	900	8010693124985

## IMBALLO / PACKING

Pz. Pc.	Tipo Type	Larghezza Width	Profondità Depth	Altezza Height
1	sfuso/bulk	600	400	320

Tutte le misure sono espresse in millimetri / All measures are in millimeters

# > VOYAGER

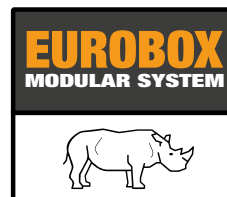

Modularità: sul VOYAGER è possibile impilare tutti i contenitori Eurobox per ottenere un maggior spazio di carico

*Modularity: it's possible to stack all the Eurobox boxes on the VOYAGER to get more cargo space*



Struttura: il VOYAGER è composto di una struttura metallica verniciata che ne garantisce la solidità e una elevata portata di carico

*Structure: the VOYAGER is composed of a painted metal structure that guarantees its solidity and a high load capacity*



prodotto in polipropilene  
produced in polypropylene



non assorbe gli odori  
odor-proof



non trattiene umidità  
doesn't retain humidity



semplice sistema di assemblaggio  
easy assembly system

Prodotto italiano ecosostenibile  
Eco-sustainable italian product

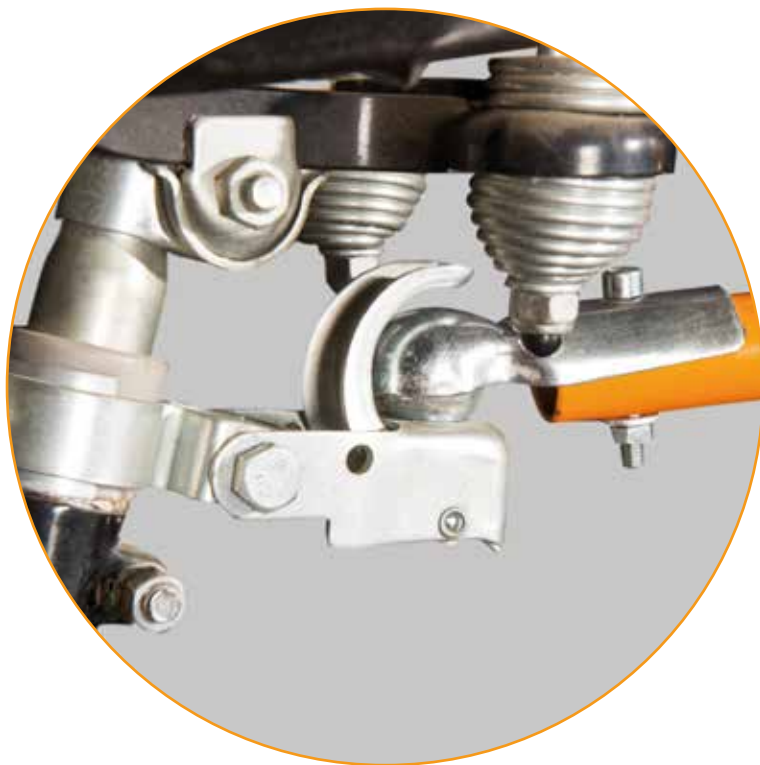

Il carrello Voyager viene agganciato al tubo sella della bicicletta tramite un semplice snodo

*Voyager is attached to the seat tube of the bicycle by a simple joint*



Il VOYAGER è un ottimo compagno di viaggio, apprezzato dai cicloturisti e cicloamatori per la sua robustezza e versatilità, fornisce un accessorio modulabile in base alle proprie necessità, dal viaggio eccezionale alla spesa quotidiana.

*The VOYAGER is an excellent travel companion, appreciated by tourists and amateur cyclists for its sturdiness and versatility, it provides an adaptable accessory according to your needs, from the exceptional journey to the daily shopping.*

# Linea **CARBON**

## **BAULI TETTO AUTO**

I bauli auto della linea Carbon nascono dalla collaborazione con esperti nel settore automotive. Lo studio sia dell'aerodinamica che delle soluzioni degli ingombri interni è arricchito dal design sportivo ed elegante dell'effetto carbonio. Adattabile ad ogni modello di auto, montaggio facile e veloce.

### *CAR ROOF BOXES*

*Carbon Line born thanks to the collaboration with some of best experts in automotive. The result of the study both of aerodynamic impact and internal spaces is implemented by sport and elegant design with a carbon look. Suitable for any car, easy and fast assembly.*

## **BLOCKING SYSTEM**

### **NUOVO SISTEMA DI BLOCCO**

*New blocking system*

Apertura e chiusura rapida e pratica del box auto a doppio scatto.

*Quick and practical opening and closing of the double-click car roof boxe*



Certificato n. Z1A 087737 0006

**CITY CRASH** (✓)

According to ISO/ PAS 11154 2006

## Caratteristiche principali

### Main features

- Montaggio facile e veloce  
*Easy and fast assembly*
- Economico e adattabile ad ogni auto  
*Economic and suitable for any car*
- Prodotti in polipropilene, materiale antiurto, resistente al freddo, alle intemperie, agli oli e ai solventi  
*Produced in polypropylene, shock proof material, water proof and resistant against solvents and oils*
- Prodotti con plastica rigenerata, riciclabile e conforme alla normativa REACH  
*Produced with regenerated and recyclable plastic, in compliance with REACH regulation*





ArtPlast

# SHIELD

Linea  
**CARBON**



Certificato n. Z1A 087737 0006

## CITY CRASH (✓)

According to ISO/ PAS 11154 2006

max 80 mm - 3,15 in

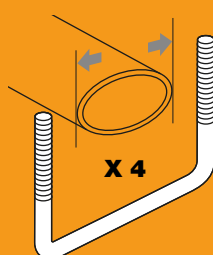

X 8



X 8

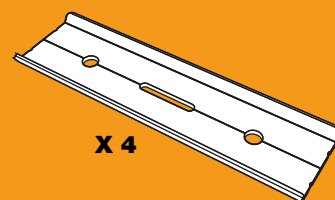

X 4

# > SHIELD Small

Prodotto italiano ecosostenibile  
Eco-sustainable italian product



## BAULI TETTO AUTO

Car roof boxes



prodotto in polipropilene  
produced in polypropylene



non assorbe gli odori  
odor-proof



non trattiene umidità  
doesn't retain humidity



semplice sistema di assemblaggio  
easy assembly system

**Apertura a scatto con auto bloccaggio**

Snap opening with self-locking

**Chiusura veloce con scatto di sblocco**

Quick closing with release click



**BA320**

**CAPACITÀ**  
Capacity

**320 Lt**

**55Kg**



**Chiusura di sicurezza anteriore**

Front safety lock

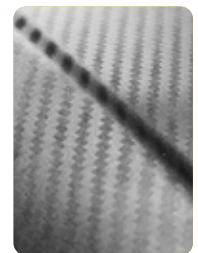

**Effetto carbonio ad alta definizione**

High definition carbon fiber texture



**Assale di chiusura in alluminio**

Aluminium locking system



**Supporti in acciaio al 100%**

100% steel parts



**Predisposto per tutti gli interassi (min 495 mm max 855 mm)**

Predisposed for every distances (min 495 mm max 855 mm)



### ARTICOLO / ARTICLE

Lunghezza Length	Profondità Depth	Altezza Height	Codice a barre Barcode
1330	778	345	8010693101504

### IMBALLO / PACKING

Pz. Pc.	Tipo Type	Larghezza Width	Profondità Depth	Altezza Height
1	cartone/carton	350	785	1340

Tutte le misure sono espresse in millimetri / All measures are in millimeters

Linea  
**CARBON**

  
ArtPlast

**SHIELD**



Certificato n. Z1A 087737 0006

**CITY CRASH** (✓)

According to ISO/ PAS 11154 2006

max 80 mm - 3,15 in

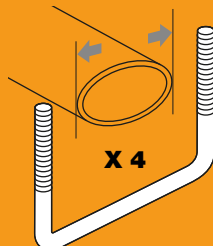

X 8



X 8

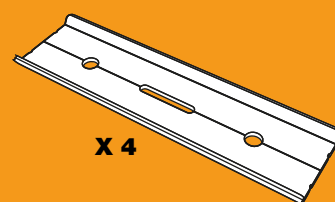

X 4



# > SHIELD Medium

Prodotto italiano ecosostenibile  
Eco-sustainable italian product



prodotto in polipropilene  
produced in polypropylene



non assorbe gli odori  
odor-proof



non trattiene umidità  
doesn't retain humidity



semplice sistema di assemblaggio  
easy assembly system

**Apertura a scatto con auto bloccaggio**  
*Snap opening with self-locking*

**Chiusura veloce con scatto di sblocco**  
*Quick closing with release click*



**BA400/PA**

**CAPACITÀ**  
*Capacity*

**400 Lt**

**75Kg**

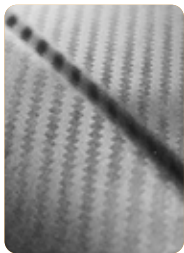

**Effetto carbonio ad alta definizione**  
*High definition carbon fiber texture*



**Supporti in acciaio al 100%**  
*100% steel parts*



**Assale di chiusura in alluminio**  
*Aluminium locking system*



**Chiusura di sicurezza anteriore**  
*Front safety lock*



**Predisposto per tutti gli interassi (min 495 mm - max 855 mm)**  
*Predisposed for every distances (min 495 mm - max 855 mm)*



## ARTICOLO / ARTICLE

Lunghezza Lenght	Profondità Depth	Altezza Height	Codice a barre Barcode
1690	790	375	8010693125098

## IMBALLO / PACKING

Pz. Pc.	Tipo Type	Larghezza Width	Profondità Depth	Altezza Height
1	cartone/carton	285	800	1700

Tutte le misure sono espresse in millimetri / All measures are in millimeters



ArtPlast

# SHIELD

## Linea CARBON



Certificato n. Z1A 087737 0006

### CITY CRASH (✓)

According to ISO/ PAS 11154 2006

max 80 mm - 3,15 in

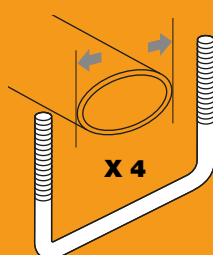

X 8



X 8

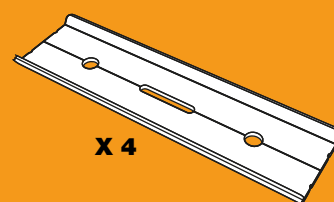

X 4

# > SHIELD Large

Prodotto italiano ecosostenibile  
Eco-sustainable italian product



## BAULI TETTO AUTO

Car roof boxes



prodotto in polipropilene  
produced in polypropylene



non assorbe gli odori  
odor-proof



non trattiene umidità  
doesn't retain humidity



semplice sistema di assemblaggio  
easy assembly system

**Apertura a scatto con auto bloccaggio**  
Snap opening with self-locking

**Chiusura veloce con scatto di sblocco**  
Quick closing with release click



**BA480/PA**

**CAPACITÀ**  
Capacity

**480 Lt**

**75Kg**

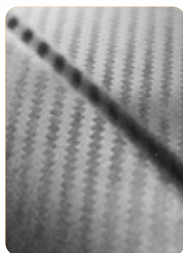

**Effetto carbonio ad alta definizione**  
High definition carbon fiber texture



**Supporti in acciaio al 100%**  
100% steel parts



**Assale di chiusura in alluminio**  
Aluminium locking system



**Chiusura di sicurezza anteriore**  
Front safety lock system



**Predisposto per tutti gli interassi (min 495 mm - max 855 mm)**  
Predisposed for every distances (min 495 mm - max 855 mm)



### ARTICOLO / ARTICLE

### IMBALLO / PACKING

Lunghezza Length	Profondità Depth	Altezza Height	Codice a barre Barcode
2005	790	380	8010693118205

Pz. Pc.	Tipo Type	Larghezza Width	Profondità Depth	Altezza Height
1	cartone/carton	285	800	2040

Tutte le misure sono espresse in millimetri / All measures are in millimeters

NEW! NEW! NEW!

# Linea **CARBON**



CE



Certificato n. Z1A 087737 0006

**CITY CRASH (✓)**

According to ISO/ PAS 11154 2006



# > GLOBETROTTER Small

Prodotto italiano ecosostenibile  
Eco-sustainable italian product



## BAULI TETTO AUTO

Car roof boxes



prodotto in polipropilene  
produced in polypropylene



non assorbe gli odori  
odor-proof



non trattiene umidità  
doesn't retain humidity



semplice sistema di assemblaggio  
easy assembly system

**Apertura a scatto con auto bloccaggio**

Snap opening with self-locking

**Chiusura veloce con scatto di sblocco**

Quick closing with release click



**BA320/GT**

CAPACITÀ  
Capacity

**320 Lt**

**55Kg**



**Chiusura di sicurezza anteriore**

Front safety lock

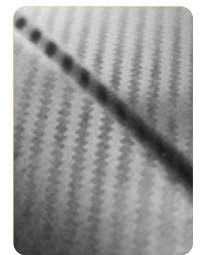

**Effetto carbonio ad alta definizione**

High definition carbon fiber texture



**Assale di chiusura in alluminio**

Aluminium locking system

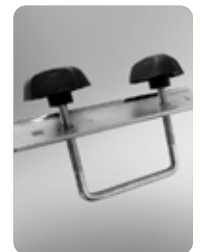

**Supporti in acciaio al 100%**

100% steel parts



**Predisposto per tutti gli interassi (min 495 mm max 855 mm)**

Predisposed for every distances (min 495 mm max 855 mm)



### ARTICOLO / ARTICLE

Lunghezza Length	Profondità Depth	Altezza Height	Codice a barre Barcode
1330	778	345	8010693126385

**BA320/GT**

### IMBALLO / PACKING

Pz. Pc.	Tipo Type	Larghezza Width	Profondità Depth	Altezza Height
1	cartone/carton	1340	785	350

Tutte le misure sono espresse in millimetri / All measures are in millimeters

NEW! NEW! NEW!

## Linea **CARBON**

# Globetrotter

AUTOMOTIVE DIVISION

WWW.ARTPLAST.IT

La nuova serie GLOBETROTTER della linea Carbon è stata pensata per dare più comodità e sicurezza al viaggiatore, grazie al nuovo sistema a "DOPPIA APERTURA LATERALE" sui modelli BA400/PA/DS e BA480/PA/DS.

*The new GLOBETROTTER series of the Carbon line has been designed to give more comfort and safety to the traveller, thanks to the new "DOUBLE LATERAL OPENING" system on the BA400/PA/DS and BA480/PA/DS models.*

CE



Certificato n. Z1A 087737 0006

**CITY CRASH** (✓)

According to ISO/ PAS 11154 2006



# > GLOBETROTTER Medium

Prodotto italiano ecosostenibile  
Eco-sustainable italian product



## BAULI TETTO AUTO

Car roof boxes



prodotto in polipropilene  
produced in polypropylene



non assorbe gli odori  
odor-proof



non trattiene umidità  
doesn't retain humidity



semplice sistema di assemblaggio  
easy assembly system

**Apertura a scatto con auto bloccaggio**  
Snap opening with self-locking

**Chiusura veloce con scatto di sblocco**  
Quick closing with release click

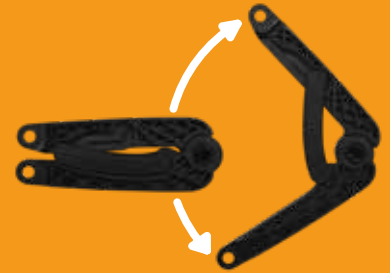

**CAPACITÀ**  
Capacity  
**400 Lt**

**75Kg**

**BA400/PA/DS**

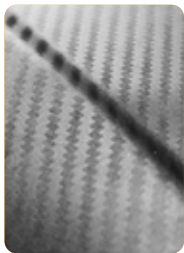

**Effetto carbonio ad alta definizione**  
High definition carbon fiber texture



**Supporti in acciaio al 100%**  
100% steel parts



**Assale di chiusura in alluminio**  
Aluminium locking system



**Chiusura di sicurezza anteriore**  
Front safety lock



**Predisposto per tutti gli interassi (min 495 mm - max 855 mm)**  
Predisposed for every distances (min 495 mm - max 855 mm)



## DOPPIA APERTURA DOUBLE-SIDED OPENING

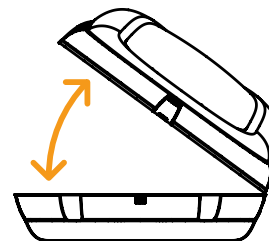

**APERTURA A DESTRA**  
Opening to the right

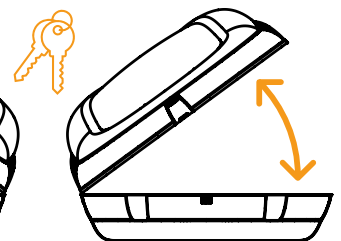

**APERTURA A SINISTRA**  
Opening to the left

### ARTICOLO / ARTICLE

Lunghezza Length	Profondità Depth	Altezza Height	Codice a barre Barcode
1690	790	375	8010693126286

**BA400/PA/DS**

### IMBALLO / PACKING

Pz. Pc.	Tipo Type	Larghezza Width	Profondità Depth	Altezza Height
1	cartone/carton	1700	800	285

Tutte le misure sono espresse in millimetri / All measures are in millimeters

NEW! NEW! NEW!

## Linea **CARBON**

# Globetrotter

AUTOMOTIVE DIVISION

WWW.ARTPLAST.IT

La nuova serie GLOBETROTTER della linea Carbon è stata pensata per dare più comodità e sicurezza al viaggiatore, grazie al nuovo sistema a "DOPPIA APERTURA LATERALE" sui modelli BA400/PA/DS e BA480/PA/DS.

*The new GLOBETROTTER series of the Carbon line has been designed to give more comfort and safety to the traveller, thanks to the new "DOUBLE LATERAL OPENING" system on the BA400/PA/DS and BA480/PA/DS models.*

CE



Certificato n. Z1A 087737 0006

**CITY CRASH** (✓)

According to ISO/ PAS 11154 2006





# > GLOBETROTTER Large

Prodotto italiano ecosostenibile  
Eco-sustainable italian product



## BAULI TETTO AUTO

Car roof boxes



prodotto in polipropilene  
produced in polypropylene



non assorbe gli odori  
odor-proof



non trattiene umidità  
doesn't retain humidity



semplice sistema di assemblaggio  
easy assembly system

**Apertura a scatto con auto bloccaggio**  
Snap opening with self-locking

**Chiusura veloce con scatto di sblocco**  
Quick closing with release click



**CAPACITÀ**  
Capacity  
**480 Lt**

**75Kg**

**BA480/PA/DS**

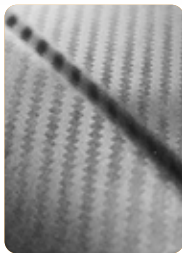

**Effetto carbonio ad alta definizione**  
High definition carbon fiber texture



**Supporti in acciaio al 100%**  
100% steel parts



**Assale di chiusura in alluminio**  
Aluminium locking system



**Chiusura di sicurezza anteriore**  
Front safety lock



**Predisposto per tutti gli interassi (min 495 mm - max 855 mm)**  
Predisposed for every distances (min 495 mm - max 855 mm)



## DOPPIA APERTURA DOUBLE-SIDED OPENING

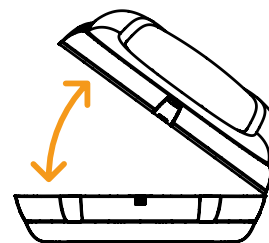

**APERTURA A DESTRA**  
Opening to the right

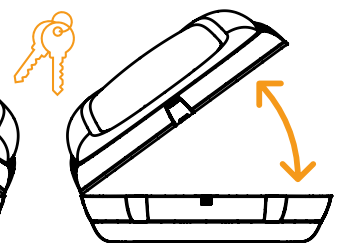

**APERTURA A SINISTRA**  
Opening to the left

### ARTICOLO / ARTICLE

Lunghezza Lenght	Profondità Depth	Altezza Height	Codice a barre Barcode
2005	790	380	8010693119189

**BA480/PA/DS**

### IMBALLO / PACKING

Pz. Pc.	Tipo Type	Larghezza Width	Profondità Depth	Altezza Height
1	cartone/carton	2040	800	285

Tutte le misure sono espresse in millimetri / All measures are in millimeters

# Linea **TENAX**

## **Chicchi di riso**

Piastrella in PVC morbida, superficie con disegno in rilievo "chicchi di riso". Ideale per laboratori, garages, palestre, sale gioco, sale espositive, stabilimenti, rivestimento temporaneo, piano carico furgoni, luoghi pubblici.

Caratteristiche: durevole e tenace, facile da pulire, buon isolamento termico e acustico, resistente alla maggior parte di solventi e agenti chimici, riduce danni causati dall'impatto e vibrazioni, antiscivolo, antifatica, semplice da installare e rimuovere, protegge il pavimento sottostante, elimina la polvere dovuta al vecchio pavimento in cemento.

*Floor tile in PVC, surface with design in relief like "grain of rice". Fit for workshops, garages, gym centre, events, games rooms, factories, temporary floor protection, loading plane of vehicles. Characteristics: durable and strong, easy to clean, good thermal and acoustic insulation, resistant to most chemicals and solvents, reduces damage resulting from impact and vibration, anti-slip, anti-fatigue property, quick to install and remove, protects the floor, eliminates the dust of the old concrete floor.*



Bordura che si può tagliare a 45° per unire l'angolo  
*Edge can be cut at 45° to join the corner*

**CERTIFICAZIONE CSI**  
CSI CERTIFICATION



**Certificato reazione al fuoco per pavimentazioni.**

**Certification reaction to fire for floorings.**



**1 mq=4,3 piastrelle/tiles**

# > Linea **TENAX** Chicchi di riso Grains of rice

Prodotto italiano ecosostenibile  
Eco-sustainable italian product



prodotto in  
PVC  
produced in  
PVC



non assorbe  
gli odori  
odor-proof



non trattiene  
umidità  
doesn't retain  
humidity



semplice sistema  
di assemblaggio  
easy assembly  
system



**P50CRN**



**PS50CRN/M/1**

**PS50CRN/F/1**



**PS50CRG/M/1**

**PS50CRG/F/1**

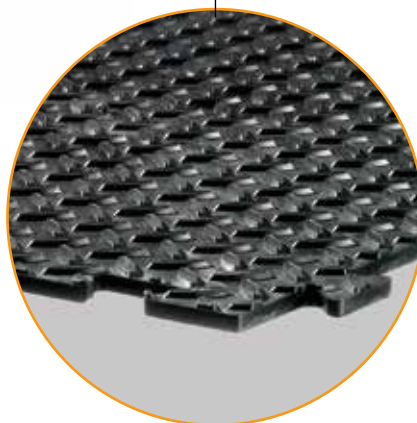

**P50CRN/ESP**

## ARTICOLO / ARTICLE

	Larghezza Width	Profondità Depth	Altezza Height	Colore Color	Codice a barre Barcode
<b>P50CRN</b>	500	500	10	●	8010693108183
<b>P50CRN/ESP</b>	500	500	10	●	8010693108183
<b>PS50CRN/M/1</b>	480	70	10	●	8010693117390
<b>PS50CRN/F/1</b>	480	51	10	●	8010693117383
<b>PS50CRG/M/1</b>	480	70	10	●	8010693117376
<b>PS50CRG/F/1</b>	480	51	10	●	8010693117369

## IMBALLO / PACKING

Pz. Pc.	Tipo Type	Larghezza Width	Profondità Depth	Altezza Height
10	cartone/carton	518	511	107
92	espositore/display	513	513	916
10	cartone/carton	495	80	95
10	cartone/carton	495	80	95
10	cartone/carton	495	80	95
10	cartone/carton	495	80	95

Tutte le misure sono espresse in millimetri / All measures are in millimeters

# Linea **TENAX**

## **Bolle**

Piastrella in PVC morbida, superficie con disegno in rilievo "a bolle". Ideale per laboratori, garages, palestre, sale gioco, sale espositive, stabilimenti, rivestimento temporaneo, piano carico furgoni, luoghi pubblici. Caratteristiche: durevole e tenace, facile da pulire, buon isolamento termico e acustico, resistente alla maggior parte di solventi e agenti chimici, riduce danni causati dall'impatto e vibrazioni, antiscivolo, antifatica, semplice da installare e rimuovere, protegge il pavimento sottostante, elimina la polvere dovuto al vecchio pavimento in cemento.

*Floor tile in PVC, surface with design in relief like "bubble". Fit for workshops, garages, gym centre, events, games rooms, factories, temporary floor protection, loading plane of vehicles. Characteristics: durable and strong, easy to clean, good thermal and acoustic insulation, resistant to most chemicals and solvents, reduces damage resulting from impact and vibration, anti-slip, anti-fatigue property, quick to install and remove, protects the floor, eliminates the dust of the old concrete floor.*



**Bordura che si può tagliare a 45° per unire l'angolo**  
*Edge can be cut at 45 ° to join the corner*

**CERTIFICAZIONE CSI**  
CSI CERTIFICATION



**Certificato reazione al fuoco per pavimentazioni.**

**Certification reaction to fire for floorings.**



# > Linea **TENAX** Bolle Bubble

Prodotto italiano ecosostenibile  
Eco-sustainable italian product



prodotto in  
PVC  
produced in  
PVC



non assorbe  
gli odori  
odor-proof



non trattiene  
umidità  
doesn't retain  
humidity



semplice sistema  
di assemblaggio  
easy assembly  
system

## P50BLN/ESP

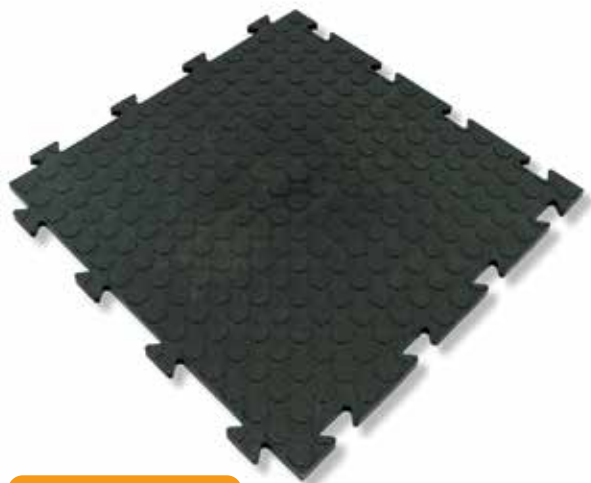

### P50BLN

1 mq=4,3 piastrelle/tiles

È possibile creare linee  
per delimitare delle aree  
*You can create lines to  
delimit areas*



### PS50BLG/M/1



### PS50BLG/F/1

### P12BLG

### P12BLN

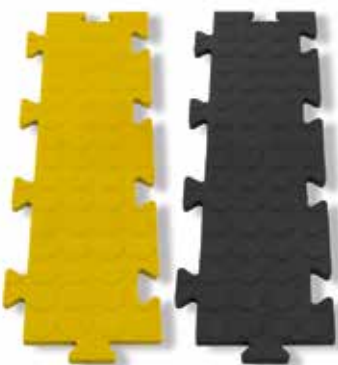

### PS50BLN/M/1



### PS50BLN/F/1

## ARTICOLO / ARTICLE

	Larghezza Width	Profondità Depth	Altezza Height	Colore Color	Codice a barre Barcode
<b>P50BLN</b>	500	500	8	●	8010693114580
<b>P50BLN/ESP</b>	500	500	8	●	8010693114580
<b>PS50BLN/M/1</b>	480	70	8	●	8010693117352
<b>PS50BLN/F/1</b>	480	51	8	●	8010693117345
<b>PS50BLG/M/1</b>	480	70	8	●	8010693117338
<b>PS50BLG/F/1</b>	480	51	8	●	8010693117321
<b>P12BLN</b>	120	500	8	●	8010693117307
<b>P12BLG</b>	120	500	8	●	8010693117314

## IMBALLO / PACKING

Pz. Pc.	Tipo Type	Larghezza Width	Profondità Depth	Altezza Height
10	cartone/carton	518	511	91
110	espositore/display	513	513	916
10	cartone/carton	495	80	95
10	cartone/carton	495	80	95
10	cartone/carton	495	80	95
10	termoretrato/shrunked	120	500	80
10	termoretrato/shrunked	120	500	80

Tutte le misure sono espresse in millimetri / All measures are in millimeters

Linea  
**TENAX**

**Mandorlato**

Piastrella in PVC morbida, superficie con disegno in rilievo "mandorlato". Ideale per laboratori, garages, palestre, sale gioco, sale espositive, stabilimenti, rivestimento temporaneo, piano carico furgoni, luoghi pubblici. **Caratteristiche:** durevole e tenace, facile da pulire, buon isolamento termico e acustico, resistente alla maggior parte di solventi e agenti chimici, riduce danni causati dall'impatto e vibrazioni, antiscivolo, antifatica, semplice da installare e rimuovere, protegge il pavimento sottostante, elimina la polvere dovuta al vecchio pavimento in cemento.

*Floor tile in PVC, surface with design in relief like "diamond plate". Fit for workshops, garages, gym centre, events, games rooms, factories, temporary floor protection, loading plane of vehicles.*

*Characteristics: durable and strong, easy to clean, good thermal and acoustic insulation, resistant to most chemicals and solvents, reduces damage resulting from impact and vibration, anti-slip, anti-fatigue property, quick to install and remove, protects the floor, eliminates the dust of the old concrete floor.*

**CERTIFICAZIONE CSI**  
CSI CERTIFICATION



**Certificato reazione al fuoco  
per pavimentazioni.**

**Certification reaction to fire  
for floorings.**



**1 mq=4,3 piastrelle/tiles**

# > Linea **TENAX** Mandorlato *Diamond plate*

Prodotto italiano ecosostenibile  
Eco-sustainable italian product



prodotto in PVC  
produced in PVC



non assorbe gli odori  
odor-proof



non trattiene umidità  
doesn't retain humidity



semplice sistema di assemblaggio  
easy assembly system



**P50MAN**

1 mq=4,3 piastrelle/tiles



**P50MAN/ESP**

**PS50MAG/M/1**



**PS50MAG/F/1**

**PS50MAN/M/1**



**PS50MAN/F/1**

## ARTICOLO / ARTICLE

	Larghezza Width	Profondità Depth	Altezza Height	Colore Color	Codice a barre Barcode
<b>P50MAN</b>	500	500	8	●	8010693116942
<b>P50MAN/ESP</b>	500	500	8	●	8010693116942
<b>PS50MAN/M/1</b>	480	70	8	●	8010693118137
<b>PS50MAN/F/1</b>	480	51	8	●	8010693118120
<b>PS50MAG/M/1</b>	480	70	8	●	8010693118038
<b>PS50MAG/F/1</b>	480	51	8	●	8010693118021

## IMBALLO / PACKING

Pz. Pc.	Tipo Type	Larghezza Width	Profondità Depth	Altezza Height
10	cartone/carton	518	511	91
110	espositore/display	513	513	916
10	cartone/carton	495	80	95
10	cartone/carton	495	80	95
10	cartone/carton	495	80	95
10	cartone/carton	495	80	95

Tutte le misure sono espresse in millimetri / All measures are in millimeters

NEW! NEW! NEW!

Linea  
**TENAX**

**Mandorlato  
piccolo**

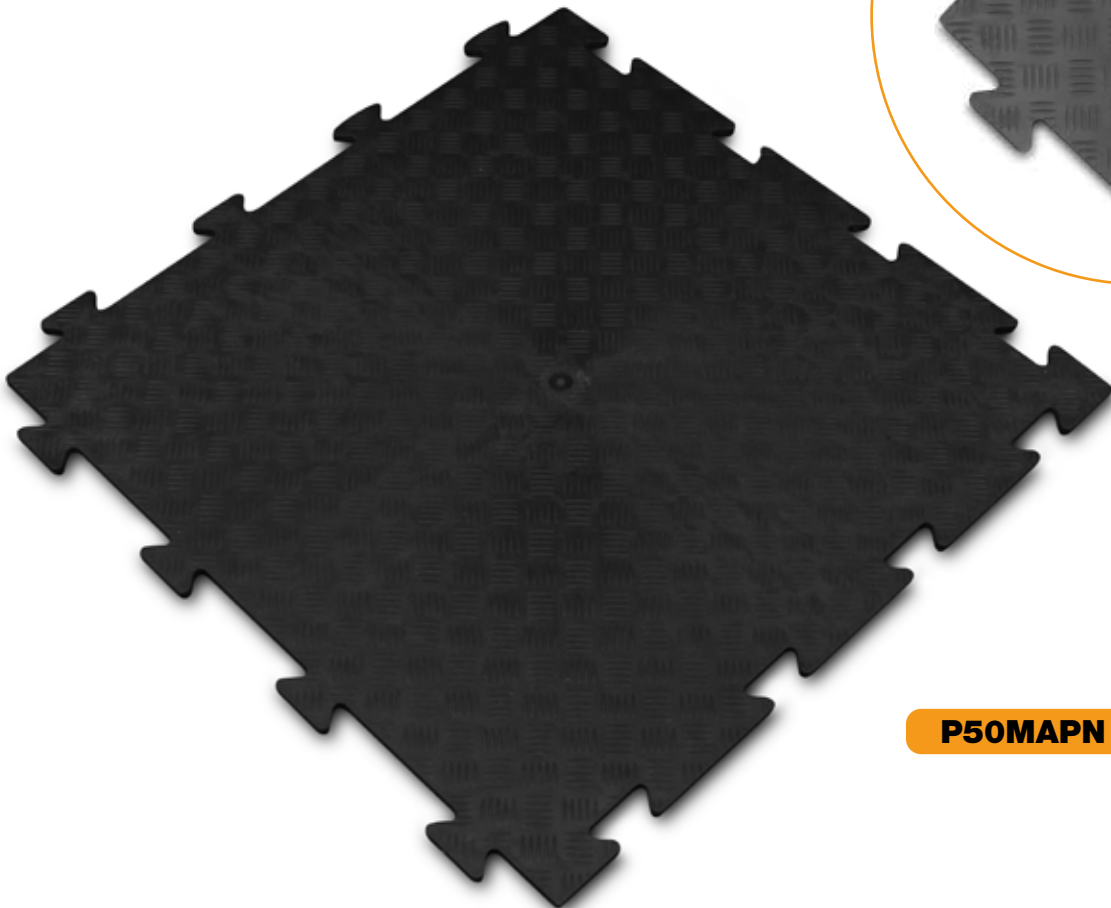
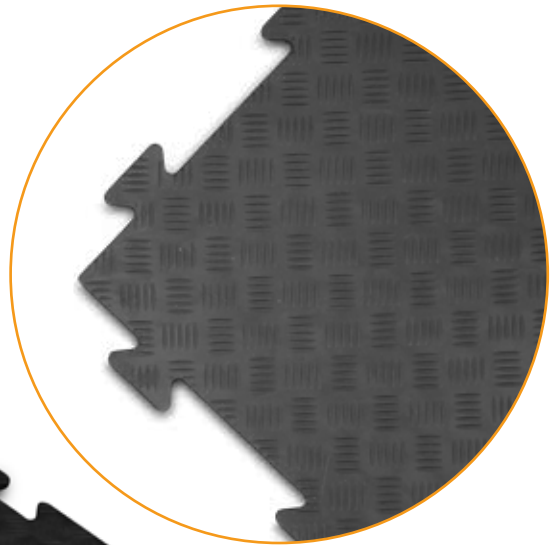
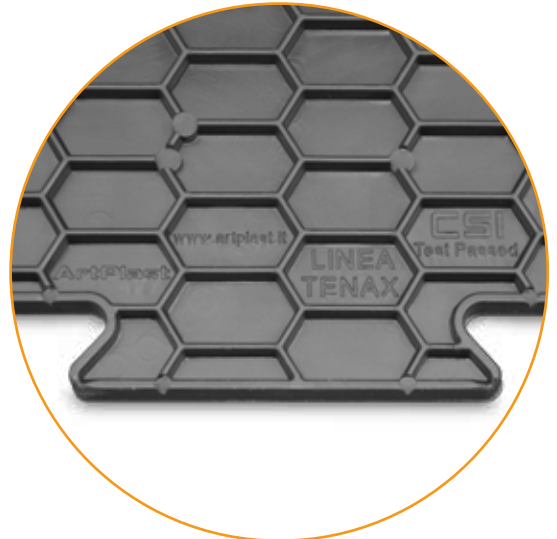

**P50MAPN**

**ARTICOLO / ARTICLE**

Larghezza Width	Profondità Depth	Altezza Height	Colore Color	Codice a barre Barcode
<b>P50MAPN</b> 500	500	8	●	8010693119110

**IMBALLO / PACKING**

Pz. Pc.	Tipo Type	Larghezza Width	Profondità Depth	Altezza Height
10	cartone/carton	518	511	91

Tutte le misure sono espresse in millimetri / All measures are in millimeters



# > Linea **TENAX** Mandorlato piccolo *Small diamond plate*

Prodotto italiano ecosostenibile  
Eco-sustainable italian product



prodotto in  
PVC  
produced in  
PVC



non assorbe  
gli odori  
odor-proof



non trattiene  
umidità  
doesn't retain  
humidity



semplice sistema  
di assemblaggio  
easy assembly  
system

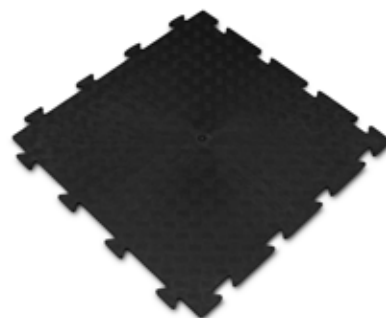

Colori personalizzati disponibili con minimo d'ordine da concordare:  
*Colors available with minimum order quantity to be agreed:*



Le migliori soluzioni per  
proteggere a costi contenuti  
qualsiasi superficie  
*The best solutions to protect any kind  
of surface*

Possibili campi di utilizzo:  
*Fields of use:*



**CERTIFICAZIONE CSI**  
CSI CERTIFICATION



**Certificato reazione al fuoco  
per pavimentazioni.**  
*Certification reaction to fire  
for floorings.*

Linea  
**TENAX**

**Defaticante**

La piastrella defaticante è prodotta in PVC morbido con disegno in rilievo "a sfere". Trova impiego nei luoghi di lavoro in cui gli addetti trascorrono molte ore in piedi, come ad esempio nel retro-banco dei bar, ed ovunque si renda utile o indispensabile fornire agli addetti uno strato soffice sul quale camminare, in modo da ridurre l'affaticamento delle gambe e delle articolazioni. Ideale anche per rivestimenti temporanei.

*Anti-fatigue floor tile is produced in PVC "bubble" like design, in relief. It is used in workplaces where workers spend many hours standing, like behind the bar, and wherever it is useful or necessary to provide soft layer on which the workers can walk, in order to reduce fatigue in the legs and joints. It is also fit for temporary floor coverings.*

**CERTIFICAZIONE CSI**  
CSI CERTIFICATION



**CSI**  
**CERT**

**Certificato reazione al fuoco  
per pavimentazioni.**

**Certification reaction to fire  
for floorings.**

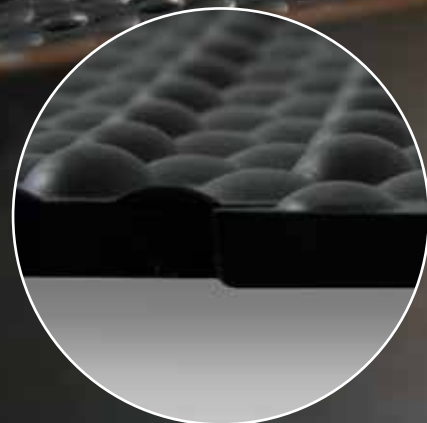

# > Linea **TENAX** Defaticante *Anti-fatigue*

Prodotto italiano ecosostenibile  
Eco-sustainable italian product



prodotto in PVC  
produced in PVC



non assorbe gli odori  
odor-proof



non trattiene umidità  
doesn't retain humidity



semplice sistema di assemblaggio  
easy assembly system

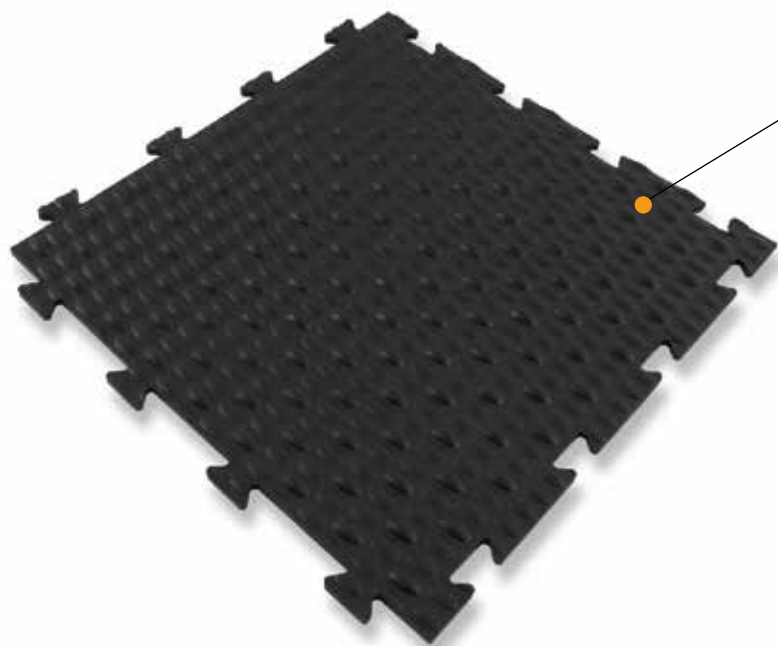

FLOORING

## P50DFN

1 mq=4,3 piastrelle/tiles



Le migliori soluzioni per proteggere a costi contenuti qualsiasi superficie  
*The best solutions to protect any kind of surface*

### Possibili campi di utilizzo:

*Fields of use:*



## Caratteristiche principali

*Main features*

- Durevole e tenace, facile da pulire  
*Durable and strong, easy to clean*
- Buon isolamento termico e acustico  
*Good thermal and acoustic insulation*
- Resistente alla maggior parte dei solventi e agenti chimici  
*Resistant to most chemicals and solvents*
- Riduce i danni da impatto e vibrazioni, antiscivolo, antifatica  
*Reduces damage from impact and vibration, anti-slip, anti-fatigue property*
- Protegge il pavimento sottostante  
*Protects the floor*
- Elimina la polvere dovuta al vecchio pavimento in cemento  
*Eliminates the dust of the old concrete floor*
- Sistema multiaggancio a 1/4 - 2/4 - 4/4  
*Multi-connection system at 1/4 - 2/4 - 4/4*

## ARTICOLO / ARTICLE

Larghezza Width	Profondità Depth	Altezza Height	Colore Color	Codice a barre Barcode
P50DFN 500	500	10	●	8010693116010

## IMBALLO / PACKING

Pz. Pc.	Tipo Type	Larghezza Width	Profondità Depth	Altezza Height
10	cartone/carton	518	511	107

Tutte le misure sono espresse in millimetri / All measures are in millimeters

Linea  
**TENAX**

**Antiscivolo**

**CERTIFICAZIONE CSI**  
CSI CERTIFICATION



**Certificato reazione al fuoco  
per pavimentazioni.**

**Certification reaction to fire  
for floorings.**



**1 mq=3 piastrelle/tiles**

### **Caratteristiche principali**

*Main features*

- Durevole e tenace, facile da pulire  
*Durable and strong, easy to clean*
- Buon isolamento termico e acustico  
*Good thermal and acoustic insulation*
- Resistente alla maggior parte dei solventi e agenti chimici  
*Resistant to most chemicals and solvents*
- Protegge il pavimento sottostante  
*Protects the floor*
- Riduce i danni da impatto e vibrazioni, antiscivolo, antifatica  
*Reduces damage from impact and vibration, anti-slip, anti-fatigue property*
- Elimina la polvere dovuta al vecchio pavimento in cemento  
*Eliminates the dust of the old concrete floor*
- Sistema multiaggancio a 1/4 - 2/4 - 4/4  
*Multi-connection system at 1/4 - 2/4 - 4/4*

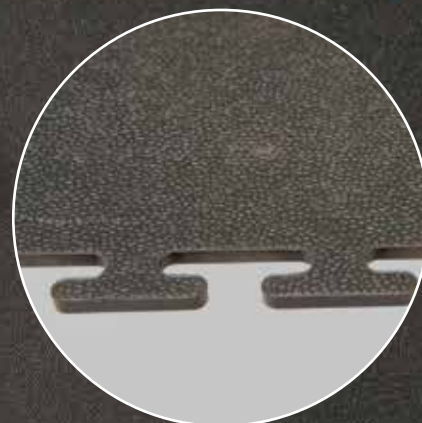

# > Linea **TENAX** Antiscivolo *Non-slip*

Prodotto italiano ecosostenibile  
Eco-sustainable italian product



prodotto in PVC  
produced in PVC



non assorbe gli odori  
doesn't absorb smells



non trattiene umidità  
doesn't retain humidity



semplice sistema di assemblaggio  
easy assembly system



adatto al traffico pesante  
suitable for heavy traffic

## ADATTA AL TRAFFICO PESANTE

*Suitable for heavy traffic*



**P60BCGS**



**P60M5BCGS**

Colori personalizzati disponibili con minimo d'ordine da concordare:  
*Colors available with minimum order quantity to be agreed :*

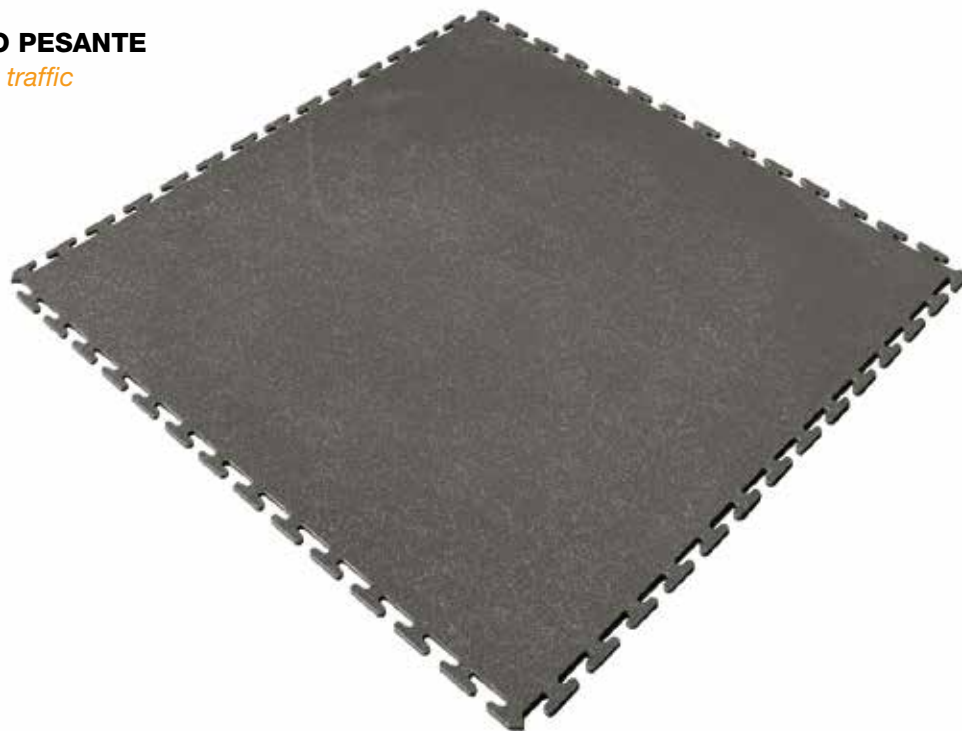
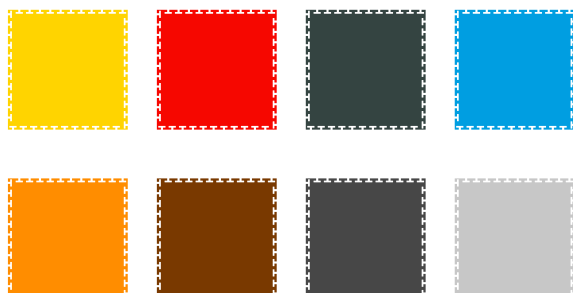

Le migliori soluzioni per proteggere a costi contenuti qualsiasi superficie  
*The best solutions to protect any kind of surface*

Possibili campi di utilizzo:  
*Fields of use:*



### ARTICOLO / ARTICLE

	Larghezza Width	Profondità Depth	Altezza Height	Colore Color	Codice a barre Barcode
<b>P60BCGS</b>	600	600	7	●	8010693117406
<b>P60M5BCGS</b>	600	600	5	●	8010693121793

### IMBALLO / PACKING

Pz. Pc.	Tipo Type	Larghezza Width	Profondità Depth	Altezza Height
1	sfuso/bulk	600	600	7
1	sfuso/bulk	600	600	5

Tutte le misure sono espresse in millimetri / All measures are in millimeters

# > Linea **TENAX - SLIM**



prodotto in polipropilene  
produced in polypropylene



non assorbe gli odori  
odor-proof



non trattiene umidità  
doesn't retain humidity



semplice sistema di assemblaggio  
easy assembly system



Le migliori soluzioni per proteggere a costi contenuti qualsiasi superficie

*The best solutions to protect any kind of surface*

Possibili campi di utilizzo:  
*Fields of use:*

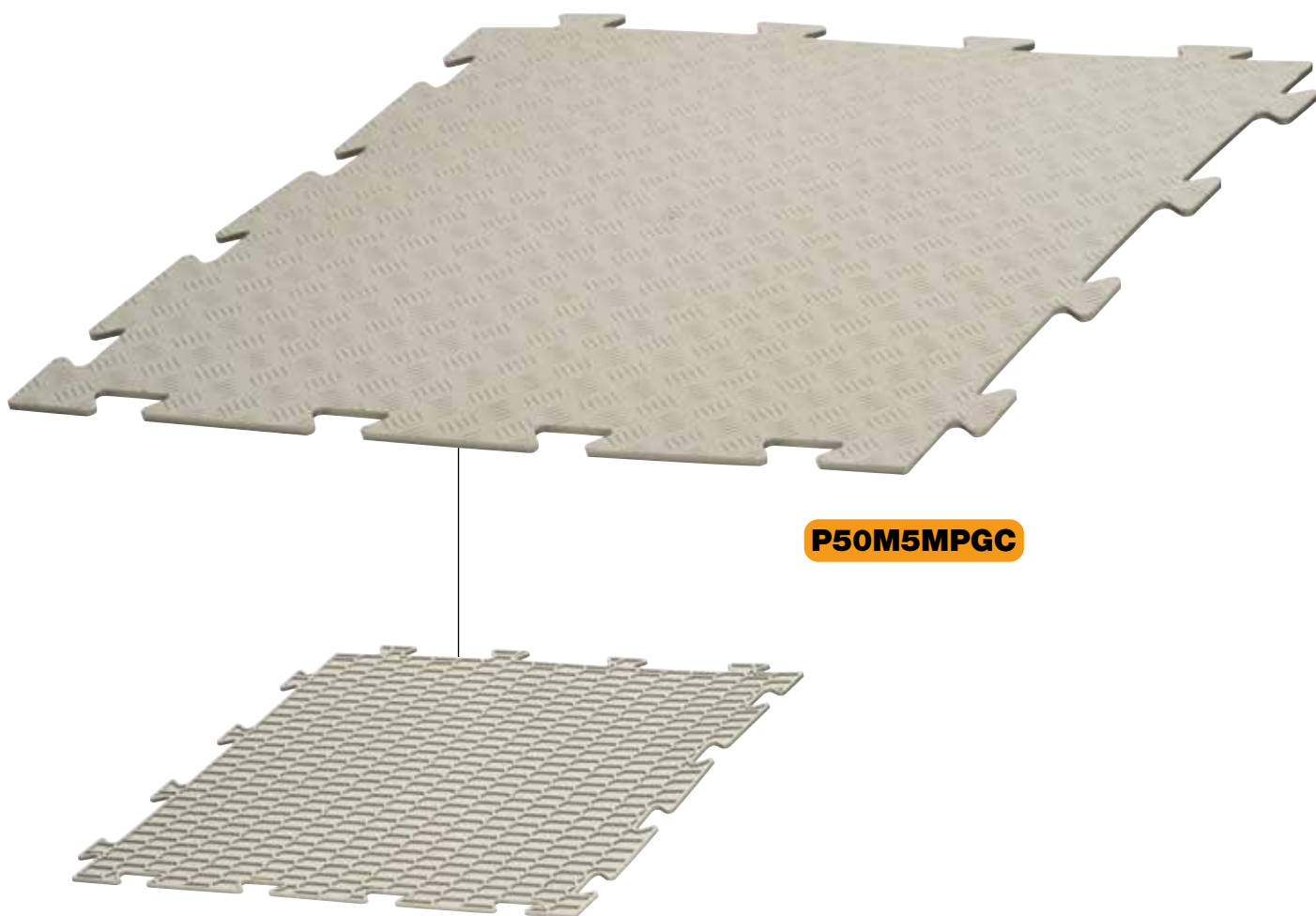

**P50M5MPGC**

Retro con struttura nervata

*Back with ribbed structure*

## ARTICOLO / ARTICLE

Larghezza Width	Profondità Depth	Altezza Height	Colore Color	Codice a barre Barcode
500	500	5	●	8010693119233

## IMBALLO / PACKING

Pz. Pc.	Tipo Type	Larghezza Width	Profondità Depth	Altezza Height
18	cartone/carton	525	515	95

**P50M5MPGC**

18 cartone/carton

**1 mq=4,3 piastrelle/tiles**

Tutte le misure sono espresse in millimetri / All measures are in millimeters

# > Linea **TENAX - SLIM**

Prodotto italiano ecosostenibile  
Eco-sustainable italian product



prodotto in polipropilene  
produced in polypropylene



non assorbe gli odori  
odor-proof



non trattiene umidità  
doesn't retain humidity



semplice sistema di assemblaggio  
easy assembly system



Le migliori soluzioni per proteggere a costi contenuti qualsiasi superficie

*The best solutions to protect any kind of surface*

Possibili campi di utilizzo:  
*Fields of use:*



**P50M5BLGC**

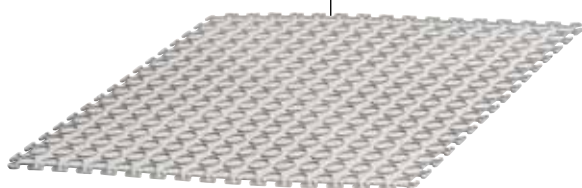

Retro con struttura nervata  
*Back with ribbed structure*



## ARTICOLO / ARTICLE

	Larghezza Width	Profondità Depth	Altezza Height	Colore Color	Codice a barre Barcode
<b>P50M5BLGC</b>	500	500	5	●	8010693119929
<b>P50M5BLAZ</b>	500	500	5	●	8010693123940
<b>P50M5BLV</b>	500	500	5	●	8010693124091

## IMBALLO / PACKING

Pz. Pc.	Tipo Type	Larghezza Width	Profondità Depth	Altezza Height
20	cartone/carton	525	515	100
20	cartone/carton	525	515	100
20	cartone/carton	525	515	100

Tutte le misure sono espresse in millimetri / All measures are in millimeters

**1 mq=4,1 piastrelle/tiles**

# Linea **ANTI TRAUMA**

## Play

**CERTIFICAZIONE UL**  
UL CERTIFICATION



**Certificato assorbimento  
impatto da altezza critica.**

***Critical height impact  
absorption certificate.***

### **Caratteristiche principali** **Main features**

- Pavimentazione antitrauma  
*Shockproof flooring*
- Composta da gomma riciclata  
*Made from recycled rubber*
- Facile da installare  
*Easy to install*
- Altamente drenante e  
si asciuga velocemente  
*Highly draining and  
dries quickly*

La pavimentazione antitrauma è nata per garantire la massima sicurezza dei nostri bambini ma non solo. È ideale per parchi gioco e aree gioco in generale dove è necessario assorbire l'impatto di caduta da un'altezza specifica. Composta da granuli di gomma riciclata derivante da pneumatici post-consumo.

*The anti-trauma flooring was created to guarantee maximum safety for our children, but not only. It is ideal for playgrounds and play areas in general where it is necessary to absorb the impact of falling from a specific height. Composed of recycled rubber granules deriving from post-consumer tires.*

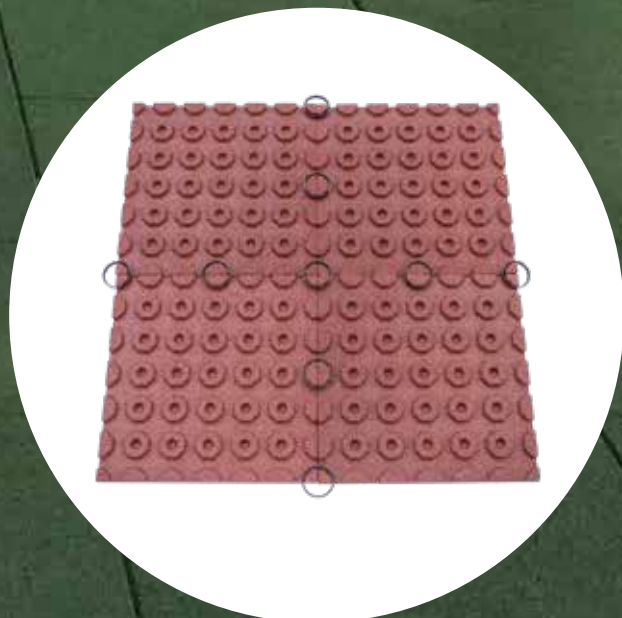

1 mq=6,2 piastrelle/tiles



# > Linea **ANTI TRAUMA** PLAY

Prodotto italiano ecosostenibile  
Eco-sustainable italian product



prodotto in gomma riciclata  
produced in recycled rubber



antitrauma  
shockproof



non assorbe gli odori  
odor-proof



non trattiene umidità  
doesn't retain humidity



semplice sistema di assemblaggio  
easy assembly system



**AT40PLAYRM**

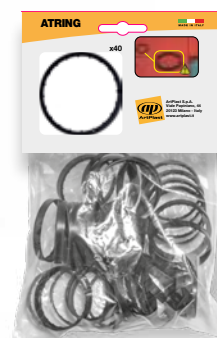

**CONFEZIONE DA 40 ANELLI**

*Pack with 40 rings*

**ATRING**



**AT40PLAYVE**



**AT40PLAYNE**

## ARTICOLO / ARTICLE

	Larghezza Width	Profondità Depth	Altezza Height	Colore Color	Codice a barre Barcode
<b>AT40PLAYNE</b>	400	400	25	●	8010693123452
<b>AT40PLAYRM</b>	400	400	25	●	8010693123469
<b>AT40PLAYVE</b>	400	400	25	●	8010693123476
<b>ATRING</b>	15	45	23	-	8010693124572

## IMBALLO / PACKING

Pz. Pc.	Tipo Type	Larghezza Width	Profondità Depth	Altezza Height
120	bancale/pallet	800	1200	630
120	bancale/pallet	800	1200	630
120	bancale/pallet	800	1200	630
10	cartone/carton	225	259	366

Tutte le misure sono espresse in millimetri / All measures are in millimeters

NEW! NEW! NEW! NEW! NEW!

# Linea **ANTI TRAUMA**

## **Gym**

Pavimentazione di sicurezza per palestre polifunzionali, centri fitness ed ogni luogo dove confort e sicurezza sono alla base di tutto.. Realizzata interamente con gomma riciclata, unisce in perfetto connubio il suo utilizzo con l'attenzione verso ambiente.

*Safety flooring for multipurpose gyms, fitness centers and all that places where safety and confort are the most important features. Made entirely with recycled rubber, it combines its use in perfect harmony with attention to the environment.*

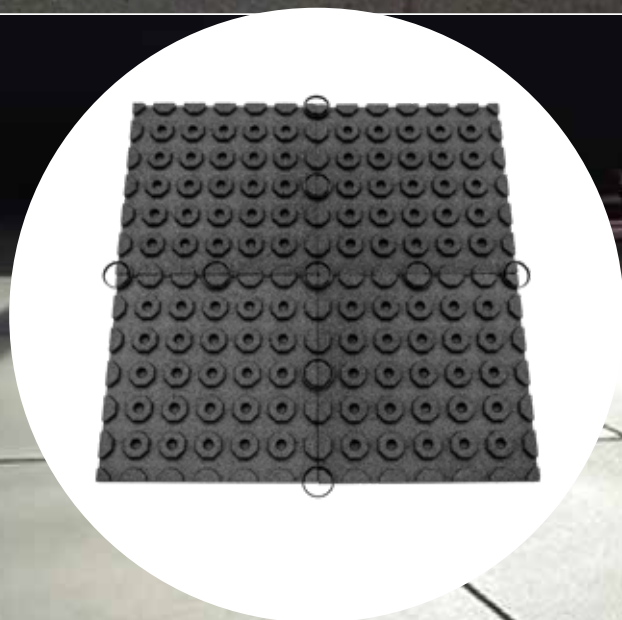

# > Linea **ANTI TRAUMA** Gym

Prodotto italiano ecosostenibile  
Eco-sustainable italian product



prodotto in gomma riciclata  
produced in recycled rubber



antitrauma  
shockproof



non assorbe gli odori  
doesn't absorb smells



non trattiene umidità  
doesn't retain humidity



semplice sistema di assemblaggio  
easy assembly system

**CERTIFICAZIONE UL**  
UL CERTIFICATION



**Certificato assorbimento impatto da altezza critica.**

**Critical height impact absorption certificate.**

**ADATTA A GRANDI PESI**

Suitable for large weights



**AT40GYMNE**



**CONFEZIONE DA 40 ANELLI**

Pack with 40 rings

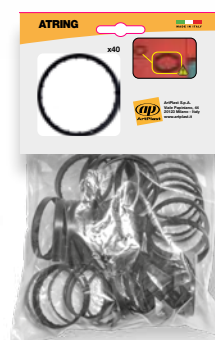

**ATRING**

## ARTICOLO / ARTICLE

	Larghezza Width	Profondità Depth	Altezza Height	Colore Color	Codice a barre Barcode
<b>AT40GYMNE</b>	400	400	25	●	8010693123490
<b>ATRING</b>	15	45	23	-	8010693124572

## IMBALLO / PACKING

Pz. Pc.	Tipo Type	Larghezza Width	Profondità Depth	Altezza Height
120	bancale/pallet	800	1200	630
10	cartone/carton	225	259	366

Tutte le misure sono espresse in millimetri / All measures are in millimeters

  
**NOVITÀ**  
New product

# Linea **GARDEN STONE**

La Piastrella Garden Stone è la soluzione ideale per ogni stagione, resistente, elegante e pratica si integra perfettamente nel vostro giardino. Resistente ai raggi UV e agli agenti atmosferici (eccetto gli eventi climatici più estremi). Non richiede nessuna manutenzione.

*The Garden Stone tile is the ideal solution for any season, durable, elegant and practical fits perfectly into your garden. Resistant to UV rays and weathering (except the most extreme climatic events).*

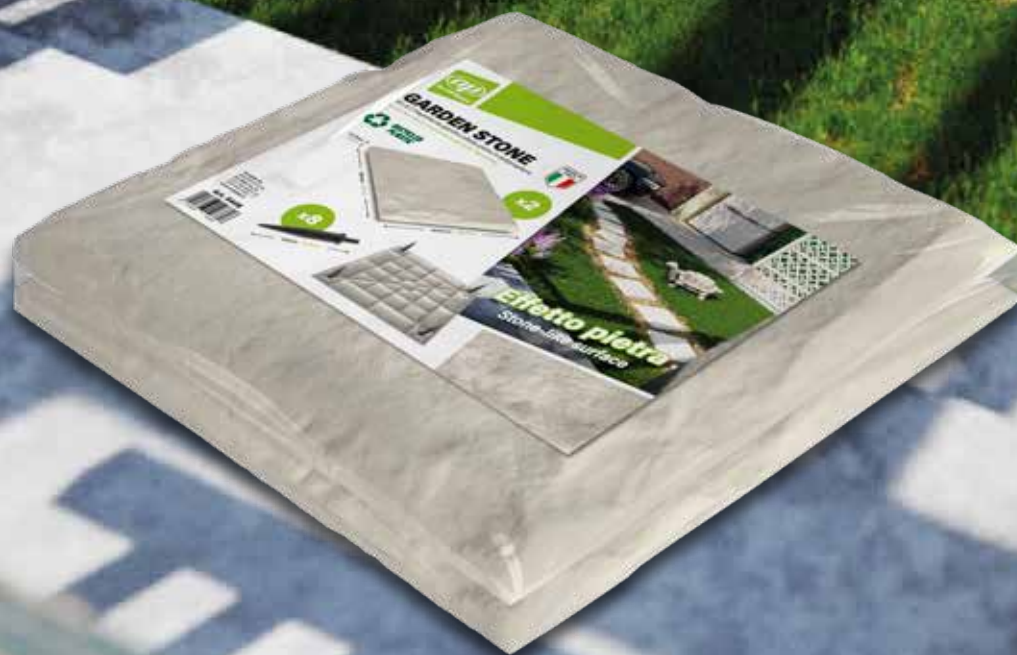

# > GARDEN STONE

Prodotto italiano ecosostenibile  
Eco-sustainable italian product



## KIT DI 2 PIASTRELLE IN POLIPROPILENE EFFETTO PIETRA

*Kit of 2 floor tiles in polypropylene with stone-like surface.*



prodotto in polipropilene  
produced in polypropylene



non assorbe gli odori  
odor-proof



non trattiene umidità  
doesn't retain humidity



semplice sistema di assemblaggio  
easy assembly system



**100% POLIPROPILENE RIGENERATO**

*100% polypropylene regenerated*



Ogni piastrella è dotata di 4 picchetti a scomparsa per un ancoraggio migliore al terreno

*Each tile is equipped with 4 hidden pegs for a better anchorage to the ground*



**S40E**

**CONFEZIONE DA 2 PIASTRELLE + 8 PICCHETTI**

*Pack of 2 tiles + 8 pickets*



Effetto pietra  
*Stone effect*



### ARTICOLO / ARTICLE

Larghezza Width	Profondità Depth	Altezza Height	Codice a barre Barcode
400	400	22,5	8010693126590

**S40E**

### IMBALLO / PACKING

Pz. Pc.	Tipo Type	Larghezza Width	Profondità Depth	Altezza Height
2	termoretrato/shrunked	400	400	50

Tutte le misure sono espresse in millimetri / All measures are in millimeters

Linea  
**MEGA TILE**



# > MEGA TILE

Prodotto italiano ecosostenibile  
Eco-sustainable italian product



prodotto in polipropilene  
produced in polypropylene



non assorbe gli odori  
odor-proof



non trattiene umidità  
doesn't retain humidity



semplice sistema di assemblaggio  
easy assembly system

PRODOTTO  
**BREVETTATO**

FLOORING



**P75M30ESGS**

Dettaglio dell'incastro maschio/femmina a scomparsa

*Detail of the recessed male / female joint*

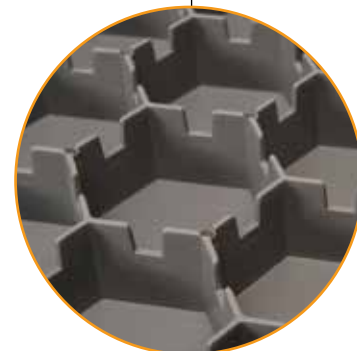

Il retro è stato progettato in modo tale che possano passare fili, tubi e cavi elettrici grazie agli appositi archi nella parte sottostante

*The back has been designed in such a way that wires, tubes and electric cables can pass through the special arcs in the lower part.*



Sistema di imballo salvaspazio brevettato

*Space-saver System*

## ARTICOLO / ARTICLE

	Larghezza Width	Profondità Depth	Altezza Height	Codice a barre Barcode
<b>P75M30ESGS</b>	1160	760	35	8010693119943

## IMBALLO / PACKING

Pz. Pc.	Tipo Type	Larghezza Width	Profondità Depth	Altezza Height
40	bancale/pallet	800	1200	1200

Tutte le misure sono espresse in millimetri / All measures are in millimeters

Linea  
**COMBI-WOOD**

Vero pino di Svezia  
termo-trattato  
impermeabile su una  
base di griglie drenanti.

*Real thermo-treated  
Sweden pine waterproof  
on a draining base.*



Legno proveniente da  
filiera certificata  
*Wood from a certified  
supply chain*



# > Linea **COMBI-WOOD**

Prodotto italiano ecosostenibile  
Eco-sustainable italian product



FLOORING

**VERO LEGNO**  
REAL WOOD

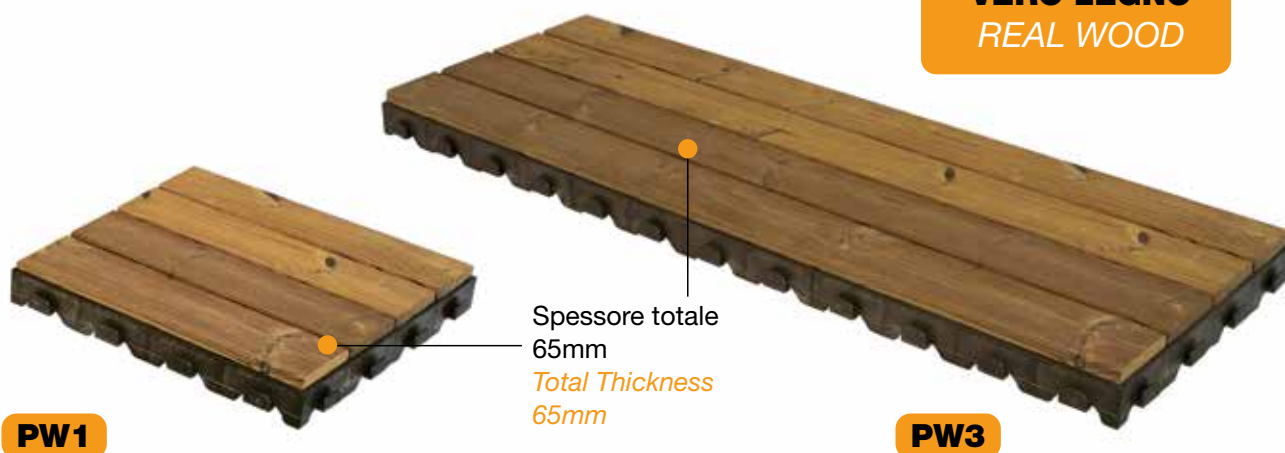

Le pedane per esterno Combi-Wood, sono un connubio perfetto di bellezza e funzionalità. Le liste di parquet in pino di Svezia sono fissate su robuste griglie drenanti, che garantiscono stabilità su qualunque tipo di superficie piana. Utilizzate negli spazi esterni della casa, bordi piscina così che ogni area possa essere resa pedonabile "con classe". Il sistema ad incastro consente una posa semplice ed estremamente rapida, permettendo di rimuovere con altrettanta facilità la pavimentazione. Il fascino del legno pino di Svezia naturale, termo-trattato, ovvero reso impermeabile da una speciale lavorazione, si accompagna alla forza drenante della struttura, per un risultato esteticamente e tecnicamente perfetto e praticamente inalterabile nel tempo.

*The outdoor footboards Combi-Wood, are the perfect harmony between aesthetic and functionality. The parquet in Sweden pine is fixed on robust draining plastic tiles that assure stability on every kind of flat surface. Used in outdoor spaces of the house, swimming pool so that each area can be made walkable "with class". The interlocking system allows a quick and easy laying and you can also remove the floor easily. The charm of the Sweden pine wood, that is thermo-treated and waterproof thanks to a special working, is accompanied by the draining force of the structure, for an aesthetically and technically perfect result, unalterable in the years.*

# > Linea **COMBI-WOOD**



**PW1**  
400x400mm

**PWS1/F**  
390x195mm

**PWS1/M**  
390x205mm

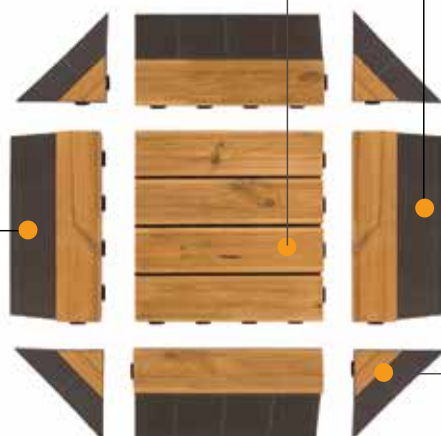

**PWA**  
Kit di 4 angolari  
*Kit of 4 corners*  
200x200mm

## ARTICOLO / ARTICLE

	Larghezza Width	Profondità Depth	Altezza Height	Codice a barre Barcode
<b>PW1</b>	400	400	65	8010693090105
<b>PWS1/F</b>	390	195	65	8010693100385
<b>PWS1/M</b>	390	205	65	8010693100378
<b>PWA</b>	100	195	65	8010693100361

## IMBALLO / PACKING

Pz. Pc.	Tipo Type	Larghezza Width	Profondità Depth	Altezza Height
108	bancale/pallet	800	1200	1200
1	sfuso/bulk	390	195	65
1	sfuso/bulk	390	205	65
1	sacchetto/bag	200	200	65

Tutte le misure sono espresse in millimetri / All measures are in millimeters



prodotto in polipropilene  
produced in polypropylene



non assorbe gli odori  
odor-proof



non trattiene umidità  
doesn't retain humidity



semplice sistema di assemblaggio  
easy assembly system

Prodotto italiano ecosostenibile  
Eco-sustainable italian product



**PW3**

1180mmx400mm

**PWS3/M**

1170x205mm

**PWS1/F**

390x195mm

**PWS1/M**

390x205mm

**PWA**

Kit di 4 angolari  
*Kit of 4 corners*

200x200mm



**PWS3/F**

1170x195mm

### ARTICOLO / ARTICLE

	Larghezza Width	Profondità Depth	Altezza Height	Codice a barre Barcode
<b>PW3</b>	1180	400	65	8010693090204
<b>PWS1/F</b>	390	195	65	8010693100385
<b>PWS1/M</b>	390	205	65	8010693100378
<b>PWS3/F</b>	1170	195	65	8010693100354
<b>PWS3/M</b>	1170	205	65	8010693100347
<b>PWA</b>	100	195	65	8010693100361

### IMBALLO / PACKING

Pz. Pc.	Tipo Type	Larghezza Width	Profondità Depth	Altezza Height
36	bancale/pallet	800	1200	1200
1	sfuso/bulk	390	195	65
1	sfuso/bulk	390	205	65
1	sfuso/bulk	1170	195	65
1	sfuso/bulk	1170	205	65
1	sacchetto/bag	200	200	65

Tutte le misure sono espresse in millimetri / All measures are in millimeters

NEW! NEW! NEW!  
NEW! NEW! NEW!  
NEW! NEW! NEW!

## Linea **WOODENSTYLE**

Struttura portante realizzata con materiale totalmente rigenerato, gli incastri disposti su due lati sono brevettati e accompagnano la dilatazione termica. Questo permette alle piastrelle di non allontanarsi e di mantenere una pavimentazione omogenea.

*Supporting structure made of totally regenerated material, the joints arranged on two sides are patented and accompany the thermal expansion. This allows the tiles not to move away and to maintain a homogeneous flooring.*

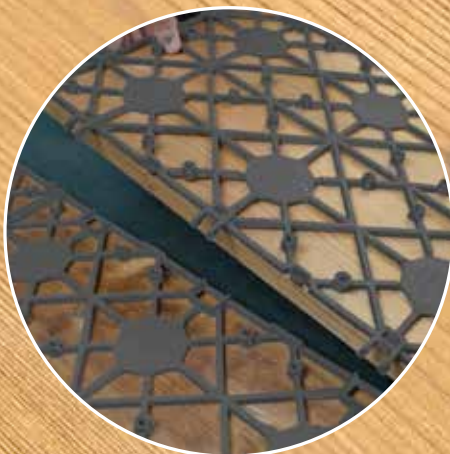

# > Linea **WOODENSTYLE**

Prodotto italiano ecosostenibile  
Eco-sustainable italian product



prodotto in polipropilene  
produced in polypropylene



non assorbe gli odori  
odor-proof



non trattiene umidità  
doesn't retain humidity



semplice sistema di assemblaggio  
easy assembly system

**VERO LEGNO**  
*REAL WOOD*



**PWQ/TT**



**PWL/TT**



**PWXL/TT**

## ARTICOLO / ARTICLE

	Larghezza Width	Profondità Depth	Altezza Height	Codice a barre Barcode
<b>PWQ/TT</b>	590	305	30	8010693126637
<b>PWL/TT</b>	590	305	30	8010693126620
<b>PWXL/TT</b>	1180	305	30	8010693126644

## IMBALLO / PACKING

Pz. Pc.	Tipo Type	Larghezza Width	Profondità Depth	Altezza Height
1	sfuso/bulk	590	305	30
1	sfuso/bulk	590	305	30
1	sfuso/bulk	1180	305	30

Tutte le misure sono espresse in millimetri / All measures are in millimeters

NEW! NEW! NEW!  
NEW! NEW! NEW!

## Linea **STONESTYLE**

Realizzata con materiale totalmente rigenerato, questa struttura portante viene definita “galleggiante” perchè accoglie entro i limiti delimitati dalla piastrella, una lastra di pietra. Inoltre la posa della piastrella è semplice e veloce.

*Made with totally regenerated material this supporting structure is called “floating” because it contains within the limits bounded by the tile, a stone slab. Moreover, the laying of the tile is quick and easy.*

PRODOTTO  
**BREVETTATO**

# > Linea **STONESTYLE**

Prodotto italiano ecosostenibile  
Eco-sustainable italian product



prodotto in polipropilene  
produced in polypropylene



non assorbe gli odori  
odor-proof



non trattiene umidità  
doesn't retain humidity



semplice sistema di assemblaggio  
easy assembly system

**VERA PIETRA**  
*REAL STONE*

## VIDEO POSA STONESTYLE

*VIDEO STONESTYLE  
INSTALLATION*



**S80GRA**

**S80**

## DISPONIBILE IN DUE COLORI

*Two colors available*



### ARTICOLO / ARTICLE

	Larghezza Width	Profondità Depth	Altezza Height	Codice a barre Barcode
<b>S80</b>	400	800	30	8010693125111
<b>S80GRA</b>	395	795	20	8010693125128

Tutte le misure sono espresse in millimetri / All measures are in millimeters

## Linea **WOODENLIKE**

La piastrella Woodenlike è prodotta in polipropilene e ha una superficie simil legno. È autoagganciante, non necessita di sottofondo, né utensili, né accessori di fissaggio. Il suo sistema di aggancio permette un rapido e semplice montaggio e si può smontare altrettanto facilmente. È adatta per uso esterno:

in giardino, campeggio, sotto il gazebo, per viottoli e passatoie, per i dehors dei bar, catering, e attività stagionali.

*The stave tile Woodenlike is made of polypropylene and has a wooden effect finishing. It is self-fastening, does not require any foundation, any tool or fixing system. It is suitable for outdoor use: in the garden, camping, under the gazebo, for paths and walkways, for dehors of bars, catering, and seasonal activities.*



Superficie effetto legno  
*Wood-effect surface*



# > Linea **WOODENLIKE**

Prodotto italiano ecosostenibile  
Eco-sustainable italian product



prodotto in polipropilene  
produced in polypropylene



non assorbe gli odori  
odor-proof



non trattiene umidità  
doesn't retain humidity



semplice sistema di assemblaggio  
easy assembly system



**P120M**

1178x157mm

25mm  
Spessore / Thickness



**PS120M/M**

580x56mm



**PS120M/F**

580x45mm



**PA120M**

54x54mm

## ARTICOLO / ARTICLE

	Larghezza Width	Profondità Depth	Altezza Height	Codice a barre Barcode
<b>P120M</b>	1178	157	25	8010693098804
<b>PS120M/M</b>	580	56	25	8010693099108
<b>PS120M/F</b>	580	45	25	8010693099207
<b>PA120M</b>	kit con 4 pz./kit with 4 pcs.		25	8010693099306
	54	54		

## IMBALLO / PACKING

Pz. Pc.	Tipo Type	Larghezza Width	Profondità Depth	Altezza Height
130	bancale/pallet	1200	800	810
10	sacchetto/bag	150	150	580
10	sacchetto/bag	150	150	580
1	sacchetto/bag	120	120	25

Tutte le misure sono espresse in millimetri / All measures are in millimeters



## Linea **STRIPED**

La piastrella Striped è prodotta in polipropilene e ha una superficie rigata. È autoagganciante, non necessita di sottofondo, né utensili, né accessori di fissaggio. Il suo sistema di aggancio permette un rapido e semplice montaggio e si può smontare altrettanto facilmente. È adatta per uso esterno: in giardino, campeggio, sotto il gazebo, per viottoli e passatoie, per i dehors dei bar, catering, e attività stagionali.

*The stave tile Striped is made of polypropylene and has a rib structure finishing. It is self-fastening, does not require any foundation, any tool or fixing system. It is suitable for outdoor use: in the garden, camping, under the gazebo, for paths and walkways, for dehors of bars, catering, and seasonal activities.*

# > Linea **STRIPED**

Prodotto italiano ecosostenibile  
Eco-sustainable italian product



prodotto in polipropilene  
produced in polypropylene



non assorbe gli odori  
odor-proof



non trattiene umidità  
doesn't retain humidity



semplice sistema di assemblaggio  
easy assembly system

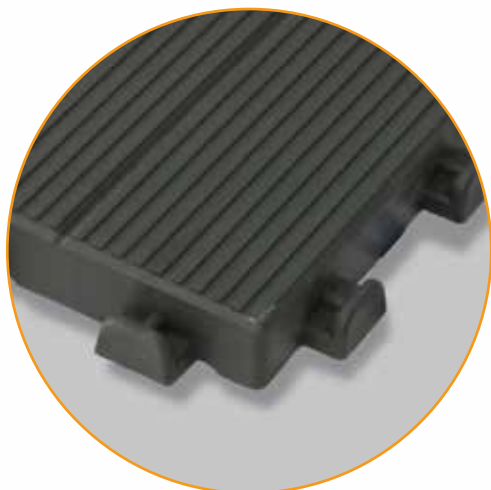

**PC120G**

1178x157mm

25mm  
Spessore / Thickness



**PS120G/M**

580x56mm



**PS120G/F**

580x45mm



**PA120G**

54x54mm

## ARTICOLO / ARTICLE

	Larghezza Width	Profondità Depth	Altezza Height	Codice a barre Barcode
<b>PC120G</b>	1178	157	25	8010693104154
<b>PS120G/M</b>	580	56	25	8010693105748
<b>PS120G/F</b>	580	45	25	8010693105731
<b>PA120G</b>	kit con 4 pz./kit with 4 pcs.		25	8010693105755
	54	54		

## IMBALLO / PACKING

Pz. Pc.	Tipo Type	Larghezza Width	Profondità Depth	Altezza Height
130	bancale/pallet	1200	800	810
10	sacchetto/bag	150	150	580
10	sacchetto/bag	150	150	580
1	sacchetto/bag	120	120	25

Tutte le misure sono espresse in millimetri / All measures are in millimeters

# Linea **COMBI**

Le piastrelle P40 e i loro elementi di finitura sono adatte per giardini, campeggi, stand, gazebo, piscine, viottoli e vivai. Facili da agganciare, possono essere montate e smontate velocemente e facilmente. Sono resistenti all'acqua, oli e solventi. Grazie ai ganci laterali si possono agganciare tra loro in modo sfalsato e ottenere diversi disegni. Sono prodotte in polipropilene caricato calcio per dare al prodotto la giusta rigidità.

*The floor tiles P40 and their finishing elements are fit for gardens, campings, stands and gazebos, swimming pools, walkways and greenhouses. Easy to assemble, can be mounted and demounted quickly and easily. They are weatherproof and resistant to oil and solvents. Thanks to the side hooks you can link one the others in a staggered way, to obtain different geometric designs. They are made of polypropylene with calcium carbonate to give the product the right stiffness.*



prodotto in polipropilene  
produced in polypropylene



non assorbe gli odori  
odor-proof



non trattiene umidità  
doesn't retain humidity



semplice sistema di assemblaggio  
easy assembly system



# > Linea **COMBI**

Prodotto italiano ecosostenibile  
Eco-sustainable italian product

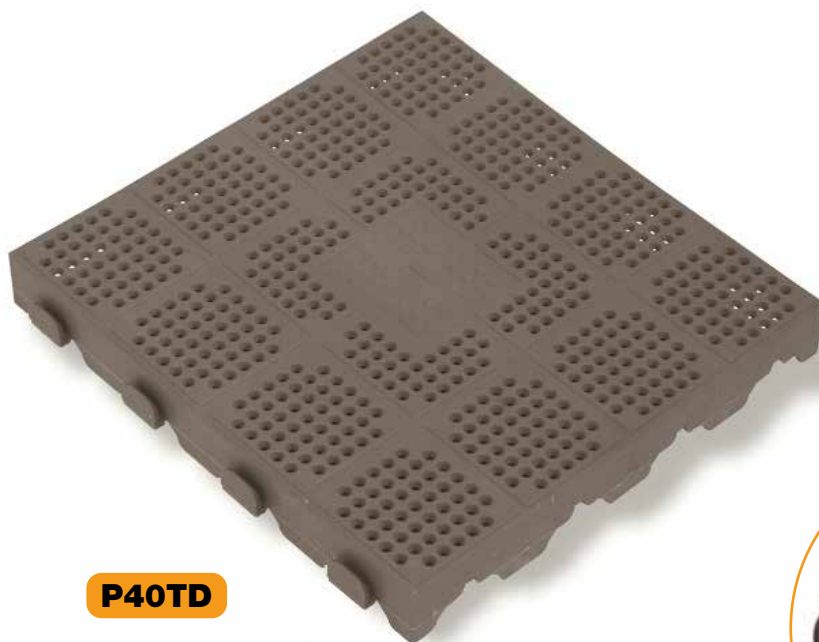

**P40TD**



**P40CD**

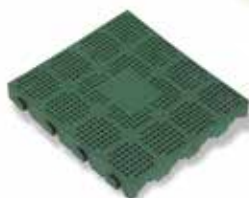

**P40VD**



**P40MD**

Supporto consigliato su  
superfici catramate  
*Recommended support on  
tarred surfaces*

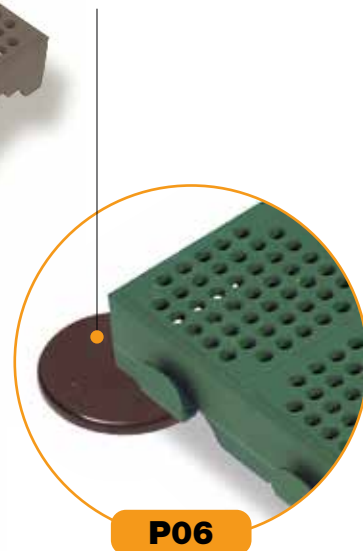

**P06**

FLOORING

## Cos'è "ReMade in Italy"?

Questa certificazione permette al prodotto di rientrare nel codice appalti per le pubbliche amministrazioni, al CAM (criteri ambientali minimi) e esonera dal pagamento della Plastic Tax.

## What is "ReMade in Italy"?

*This certification allows the product to be included in the procurement code for public administrations, in the CAM (minimum environmental criteria) and exempts the payment of the Plastic Tax.*

## Cos'è "Plastica Seconda Vita"?

ArtPlast è tra le prime aziende in Italia certificate da IPPR - Istituto per la Promozione delle Plastiche da Riciclo, con il marchio "Plastica Seconda Vita", una certificazione dedicata ai manufatti ottenuti dalla valorizzazione del riciclo dei materiali plastici. Introduce i concetti di qualità e durabilità nelle materie plastiche da riciclo e ne garantisce la tracciabilità in tutta la sua filiera.

## What is "Plastica Seconda Vita"?

*ArtPlast is among the first companies in Italy certified by IPPR (Institute for the Promotion of Recycling Plastics) with the brand "Second Life Plastic", a certification dedicated to the products obtained from the enhancement of the recycling of plastic materials. It introduces the concepts of quality and durability in recycled plastics and ensures traceability throughout its supply chain.*

## ARTICOLO / ARTICLE

	Larghezza Width	Profondità Depth	Altezza Height	Codice a barre Barcode
<b>P40CD</b>	400	400	48	8010693055005
<b>P40VD</b>	400	400	48	8010693055104
<b>P40TD</b>	400	400	48	8010693126828
<b>P40MD</b>	400	400	48	8010693083909
<b>P06</b>	60	60	5	8010693075300

## IMBALLO / PACKING

Pz. Pc.	Tipo Type	Larghezza Width	Profondità Depth	Altezza Height
120	bancale/pallet	1200	800	1060
120	bancale/pallet	1200	800	1060
120	bancale/pallet	1200	800	1060
120	bancale/pallet	1200	800	1060
500	cartone/carton	225	259	366

Tutte le misure sono espresse in millimetri / All measures are in millimeters

# > Linea **COMBI**



**P40T**



**P40C**

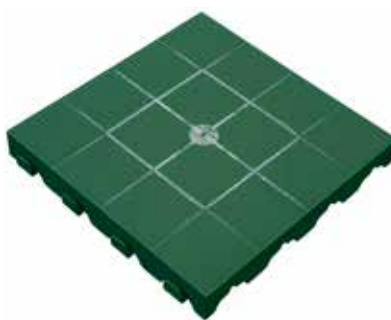

**P40V**



**P40M**

## ARTICOLO / ARTICLE

	Larghezza Width	Profondità Depth	Altezza Height	Codice a barre Barcode
<b>P40C</b>	400	400	48	8010693054701
<b>P40V</b>	400	400	48	8010693054800
<b>P40T</b>	400	400	48	8010693126835
<b>P40M</b>	400	400	48	8010693083800
<b>PAC</b>	kit con 4 pz./kit with 4 pc. : 100	195	48	8010693056002
<b>PAV</b>	kit con 4 pz./kit with 4 pc. : 100	195	48	8010693055906
<b>PAG</b>	kit con 4 pz./kit with 4 pc. : 100	195	48	8010693056101
<b>PAM</b>	kit con 4 pz./kit with 4 pc. : 100	195	48	8010693084203

## IMBALLO / PACKING

Pz. Pc.	Tipo Type	Larghezza Width	Profondità Depth	Altezza Height
120	bancale/pallet	1200	800	1060
120	bancale/pallet	1200	800	1060
120	bancale/pallet	1200	800	1060
120	bancale/pallet	1200	800	1060
1	sacchetto/bag	17	28	8
1	sacchetto/bag	17	28	8
1	sacchetto/bag	17	28	8
1	sacchetto/bag	17	28	8



prodotto in polipropilene  
produced in polypropylene



non assorbe gli odori  
odor-proof



non trattiene umidità  
doesn't retain humidity



semplice sistema di assemblaggio  
easy assembly system

Prodotto italiano ecosostenibile  
Eco-sustainable italian product



**PSC/M**



**PSV/M**



**PST/M**



**PSM/M**



**PSC/F**



**PSV/F**



**PST/F**



**PSM/F**



**PAC**



**PAV**



**PAT**



**PAM**

**ARTICOLO / ARTICLE**

	Larghezza Width	Profondità Depth	Altezza Height	Codice a barre Barcode
<b>PSC/M</b>	390	205	48	8010693059102
<b>PSV/M</b>	390	205	48	8010693058907
<b>PST/M</b>	390	205	48	8010693126842
<b>PSM/M</b>	390	205	48	8010693084104
<b>PSC/F</b>	390	195	48	8010693056309
<b>PSV/F</b>	390	195	48	8010693056200
<b>PST/F</b>	390	195	48	8010693126859
<b>PSM/F</b>	390	195	48	8010693084005

**IMBALLO / PACKING**

Pz. Pc.	Tipo Type	Larghezza Width	Profondità Depth	Altezza Height
10	reggiate/strapped	300	390	240
10	reggiate/strapped	300	390	240
10	reggiate/strapped	300	390	240
10	reggiate/strapped	300	390	240
10	reggiate/strapped	300	390	240
10	reggiate/strapped	300	390	240
10	reggiate/strapped	300	390	240
10	reggiate/strapped	300	390	240

Tutte le misure sono espresse in millimetri / All measures are in millimeters



prodotto in  
polipropilene  
produced in  
polypropylene



non assorbe  
gli odori  
odor-proof



non trattiene  
umidità  
doesn't retain  
humidity



semplice sistema  
di assemblaggio  
easy assembly  
system

## Linea **EASY**

Le piastrelle autobloccanti della Linea Easy con finitura effetto “ardesia” oppure “doghe di legno”, sono adatte per giardini, campeggi, stand, gazebo, piscine, viottoli e vivai. Facili da agganciare, possono essere montate e smontate velocemente e facilmente. Sono resistenti all'acqua, oli e solventi. Sono prodotte in polipropilene caricato calcio per dare al prodotto la giusta rigidità.

*The Easy Line self-locking tiles with “slate” or “wooden slats” finish are fit for gardens, campings, stands and gazebos, swimming pools, walkways and greenhouses. Easy to assemble, can be mounted and demounted quickly and easily. They are weatherproof and resistant to oil and solvents. They are made of polypropylene with calcium carbonate to give the product the right stiffness.*

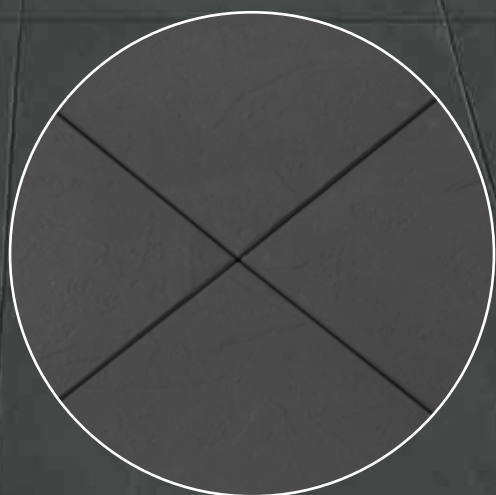

Facile da posare a mano  
*Easy to lay by hand*

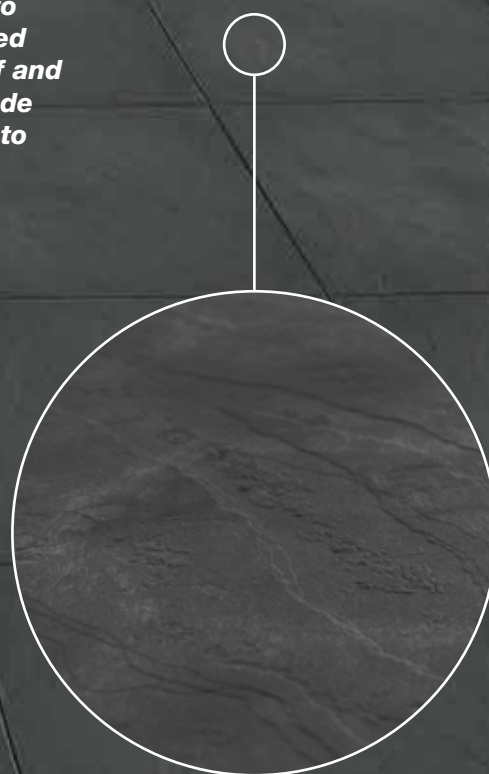

Superficie effetto “ardesia”  
*Slate-effect surface*



# > Linea **EASY**

Prodotto italiano ecosostenibile  
Eco-sustainable italian product



FLOORING

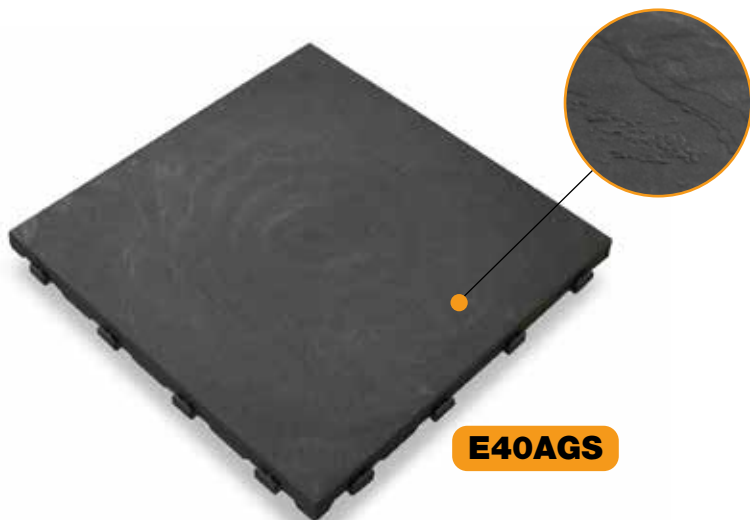

**E40AGS**



**ES40GS**

**PA120GS**



**E40LM**



**ES40M**

**PA120M**

## ARTICOLO / ARTICLE

## IMBALLO / PACKING

	Larghezza Width	Profondità Depth	Altezza Height	Codice a barre Barcode
<b>E40AGS</b>	400	400	26,5	8010693117994
<b>ES40GS</b>	kit con 6 pz./kit with 6 pcs. 390 45		25	8010693118236
<b>PA120GS</b>	kit con 4 pz./kit with 4 pcs. 54 54		25	8010693118243
<b>E40LM</b>	400	400	26,5	8010693118007
<b>ES40M</b>	kit con 6 pz./kit with 6 pcs. 390 45		25	8010693114207
<b>PA120M</b>	kit con 4 pz./kit with 4 pcs. 54 54		25	8010693099306

Pz. Pc.	Tipo Type	Larghezza Width	Profondità Depth	Altezza Height
240	bancale/pallet	1200	800	1170
1	sacchetto/bag	150	50	390
1	sacchetto/bag	45	45	25
240	bancale/pallet	1200	800	1170
1	sacchetto/bag	150	50	390
1	sacchetto/bag	45	45	25

Tutte le misure sono espresse in millimetri / All measures are in millimeters

# Linea EASY

La piastrella autobloccante in polipropilene della Linea Easy è idonea per uso esterno: vialetti, gazebo e salottini dehors, zone pic nic, dehors bar, campeggio, piscine e serre. Caratteristiche: cellette a nido d'ape sul fondo conferiscono maggiore portata, il design realizzato in modo da creare una piastrella che possa soddisfare entrambe le richieste di drenante e piena.

*Easy Line plastic floor tile in polypropylen is suitable for outdoor use: driveways, pavement under a gazebo and terrace seating, picnic areas, terrace bar, camping, swimming pools and greenhouses. Quick and easy assembly and disassembly without tools. Characteristics: honeycomb design cells on the bottom to give high loading bearing capacity, the design has been realized to create a tile that can satisfy both demands of draining and full.*



prodotto in polipropilene  
produced in polypropylene



non assorbe gli odori  
odor-proof



non trattiene umidità  
doesn't retain humidity



semplice sistema di assemblaggio  
easy assembly system



Facile da posare a mano  
Easy to lay by hand

# > Linea **EASY**

Prodotto italiano ecosostenibile  
Eco-sustainable italian product



FLOORING



**E40C**

**E40T**

**E40V**



**ES40C**

**PA120C**



**ES40T**

**PA120T**



**ES40V**

**PA120V**

## ARTICOLO / ARTICLE

	Larghezza Width	Profondità Depth	Altezza Height	Codice a barre Barcode
<b>E40C</b>	400	400	25	8010693094301
<b>ES40C</b>	kit con 6 pz./kit with 6 pc. : 390	45	25	8010693112371
<b>PA120C</b>	kit con 4 pz./kit with 4 pc. : 54	54	25	8010693112395
<b>E40V</b>	400	400	25	8010693094509
<b>ES40V</b>	kit con 6 pz./kit with 6 pc. : 390	45	25	8010693112364
<b>PA120V</b>	kit con 4 pz./kit with 4 pc. : 54	54	25	8010693112395
<b>E40T</b>	400	400	25	8010693126699
<b>ES40T</b>	kit con 6 pz./kit with 6 pc. : 390	45	25	8010693126866
<b>PA120T</b>	kit con 4 pz./kit with 4 pc. : 54	54	25	8010693126873

## IMBALLO / PACKING

Pz. Pc.	Tipo Type	Larghezza Width	Profondità Depth	Altezza Height
240	bancale/pallet	1200	800	1110
1	sacchetto/bag	150	50	390
1	sacchetto/bag	45	45	25
240	bancale/pallet	1200	800	1110
1	sacchetto/bag	150	50	390
1	sacchetto/bag	45	45	25
240	bancale/pallet	1200	800	1110
1	sacchetto/bag	150	50	390
1	sacchetto/bag	45	45	25

Tutte le misure sono espresse in millimetri / All measures are in millimeters

# Linea **MARTE**

## **Crossed**

La piastrella della Linea Marte Crossed con superficie simil-legno, è autoagganciante, non necessita di sottofondo né di utensili per il montaggio. Lo smontaggio è altrettanto semplice, si presta così anche per gli impieghi stagionali. Adatta per gazebo e dehors, terrazze, verande e balconi, ricopre la vecchia pavimentazione rinnovandola con eleganza. È prodotta in polipropilene, materiale molto resistente. I suoi elementi di finitura e angoli completano la superficie.

*Crossed Marte Line tile with a wood-like surface, is a self-fastening, does not require a substrate, nor of tools for assembly. Disassembly is just as easy, thus also suitable for seasonal jobs. Suitable for gazebos and patios, terraces, verandas and balconies, covering the old pavement renewed with elegance. It is produced in polypropylene, very resistant material. Its finishing elements and angles complete the unique surface.*

1 mq=3 piastrelle/tiles

Scivoli a pagina 273 / Ramps at page 273



**Facile da posare a mano**  
*Easy to lay by hand*



**Resistente all'acqua**  
*Waterproof*

# > Linea **MARTE** Crossed

Prodotto italiano ecosostenibile  
Eco-sustainable italian product



prodotto in polipropilene  
produced in polypropylene



non assorbe gli odori  
odor-proof



non trattiene umidità  
doesn't retain humidity



semplice sistema di assemblaggio  
easy assembly system



**P56PQGS/ESP**



**Scivoli / Ramps**

**P56PQMS**

**PA56PMS/F**

**PA56PMS/M**



**P56PQGC**



**P56PQGS**

**PA56PGM/F**

**PA56PGS/F**

**PA56PGM/M**

**PA56PGS/M**

**Scivoli / Ramps**

## ARTICOLO / ARTICLE

	Larghezza Width	Profondità Depth	Altezza Height	Colore Color	Codice a barre Barcode
<b>P56PQMS/14</b>	563	563	13	●	8010693112531
<b>P56PQMS/ESP60</b>	563	563	13	●	8010693112531
<b>P56PQGC/14</b>	563	563	13	●	8010693112555
<b>P56PQGC/ESP60</b>	563	563	13	●	8010693112555
<b>P56PQGS/14</b>	563	563	13	●	8010693114399
<b>P56PQGS/ESP60</b>	563	563	13	●	8010693114399

## IMBALLO / PACKING

Pz. Pc.	Tipo Type	Larghezza Width	Profondità Depth	Altezza Height
14	cartone/carton	575	200	580
60	cartone/carton	590	590	980
14	cartone/carton	575	200	580
60	cartone/carton	590	590	980
14	cartone/carton	575	200	580
60	cartone/carton	590	590	980

Tutte le misure sono espresse in millimetri / All measures are in millimeters

Linea  
**MARTE**

**Linear**

La piastrella della Linea Marte Linear ha una superficie simil-legno dal disegno intenso e profondo, è autoagganciante, non necessita di sottofondo né di utensili per il montaggio. Lo smontaggio è altrettanto semplice, si presta così anche per gli impieghi stagionali. Adatta per gazebo e dehors, terrazze, verande e balconi, ricopre la vecchia pavimentazione rinnovandola con eleganza. È prodotta in polipropilene, materiale molto resistente. I suoi elementi di finitura e angoli completano la superficie.

*Linear Marte Line tile has a deep and intense wood-like surface, is a self-fastening, does not require a substrate, nor of tools for assembly. Disassembly is just as easy, thus also suitable for seasonal jobs. Suitable for gazebos and patios, terraces, verandas and balconies, covering the old pavement renewed with elegance. It is produced in polypropylene, very resistant material. Its finishing elements and angles complete the unique surface.*

**1 mq=3 piastrelle/tiles**

Scivoli a pagina 273 / *Ramps at page 273*



# > Linea **MARTE** Linear

Prodotto italiano ecosostenibile  
Eco-sustainable italian product



prodotto in polipropilene  
produced in polypropylene



non assorbe gli odori  
odor-proof



non trattiene umidità  
doesn't retain humidity



semplice sistema di assemblaggio  
easy assembly system

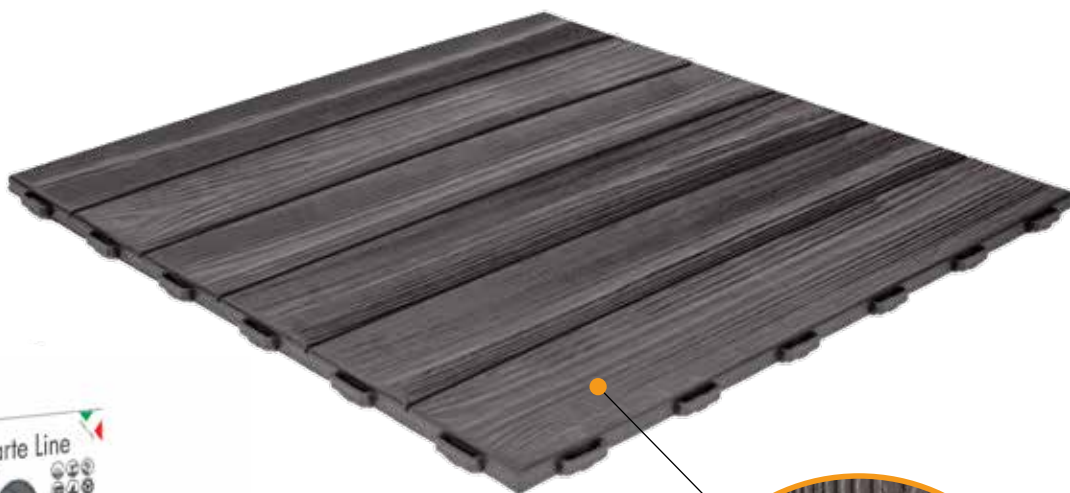

**P56PLMS/ESP**

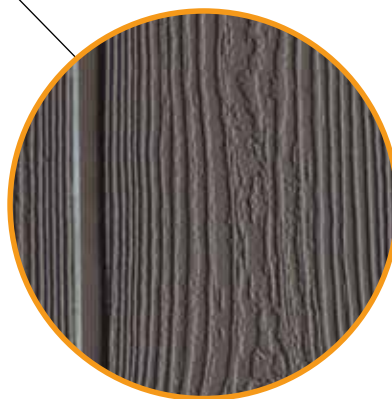

**Scivoli / Ramps**

**P56PLMS**

**PA56PMS/F**

**PA56PMS/M**

## ARTICOLO / ARTICLE

	Larghezza Width	Profondità Depth	Altezza Height	Colore Color	Codice a barre Barcode
<b>P56PLMS</b>	563	563	13	●	8010693112494
<b>P56PLMS/ESP</b>	563	563	13	●	8010693112494

## IMBALLO / PACKING

Pz. Pc.	Tipo Type	Larghezza Width	Profondità Depth	Altezza Height
14	cartone/carton	575	200	580
60	cartone/carton	590	590	980

Tutte le misure sono espresse in millimetri / All measures are in millimeters

# Linea **MARTE**

## **Draining**

Piastrella drenante, prodotta in polipropilene copolimero. Adatta per aree di lavoro, piscine, spogliatoi e docce di centri sportivi e superfici esterne, dove è richiesta una grande capacità drenante. Montaggio e smontaggio veloce e semplice senza l'utilizzo di utensili. Questa linea è completa di scivoli di finitura e angoli.

*Draining Tile, made of polypropylene copolymer. Suitable for work areas, swimming pools, changing rooms and showers in sports and outer surfaces, which require a large drainage capacity. Quick installation and easy disassembly without the use of tools. This line is completed with finishing slides and corners.*

**1 mq=3 piastrelle/tiles**

Scivoli a pagina 273 / *Ramps at page 273*





# > Linea **MARTE** Draining

Prodotto italiano ecosostenibile  
Eco-sustainable italian product



prodotto in polipropilene  
produced in polypropylene



non assorbe gli odori  
odor-proof



non trattiene umidità  
doesn't retain humidity



semplice sistema di assemblaggio  
easy assembly system

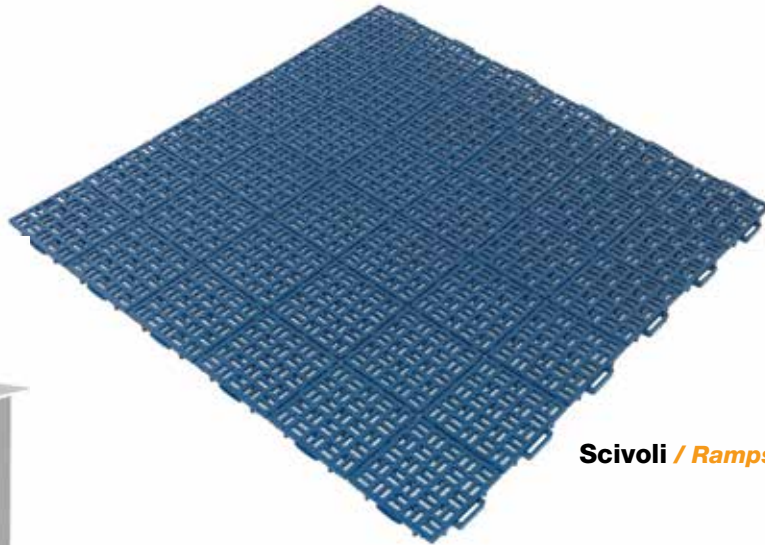

Scivoli / Ramps

**P56PBD**

**PA56PB/F**

**PA56PB/M**



**P56PBD/ESP60**

Scivoli / Ramps



**P56PMD/14**

**PA56PMS/F**

**PA56PMS/M**

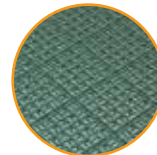

**P56PVD/14**

**PA56PV/F**

**PA56PV/M**

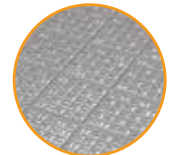

**P56PGD/14**

**PA56PGC/F**

**PA56PGC/M**

## ARTICOLO / ARTICLE

	Larghezza Width	Profondità Depth	Altezza Height	Colore Color	Codice a barre Barcode
<b>P56PVD/14</b>	563	563	13	●	8010693098903
<b>P56PVD/ESP60</b>	563	563	13	●	8010693098903
<b>P56PGD/14</b>	563	563	13	●	8010693099405
<b>P56PGD/ESP60</b>	563	563	13	●	8010693099405
<b>P56PMD/14</b>	563	563	13	●	8010693099009
<b>P56PMD/ESP60</b>	563	563	13	●	8010693099009
<b>P56PBD/14</b>	563	563	13	●	8010693114542
<b>P56PBD/ESP60</b>	390	45	25	●	8010693114542

## IMBALLO / PACKING

Pz. Pc.	Tipo Type	Larghezza Width	Profondità Depth	Altezza Height
14	cartone/carton	575	200	580
60	cartone/carton	590	590	980
14	cartone/carton	575	200	580
60	cartone/carton	590	590	980
14	cartone/carton	575	200	580
60	cartone/carton	590	590	980
14	cartone/carton	575	200	580
60	cartone/carton	590	590	980

Tutte le misure sono espresse in millimetri / All measures are in millimeters

Linea  
**MARTE**

**Scivoli /  
Ramps**



# > Linea **MARTE** Scivoli / Ramps

Prodotto italiano ecosostenibile  
Eco-sustainable italian product



prodotto in polipropilene  
produced in polypropylene











non assorbe gli odori  
odor-proof













non trattiene umidità  
doesn't retain humidity



semplice sistema di assemblaggio  
easy assembly system

					
 <b>Crossed</b>	<b>PA56PMS/F</b>	<b>PA56PGS/F</b>	<b>PA56PGC/F</b>		
	<b>PA56PMS/M</b>	<b>PA56PGS/M</b>	<b>PA56PGC/M</b>		
 <b>Linear</b>	<b>PA56PMS/F</b>				
	<b>PA56PMS/M</b>				
 <b>Draining</b>	<b>PA56PMS/F</b>		<b>PA56PGC/F</b>	<b>PA56PB/F</b>	<b>PA56PV/F</b>
	<b>PA56PMS/M</b>		<b>PA56PGC/M</b>	<b>PA56PB/M</b>	<b>PA56PV/M</b>

## ARTICOLO / ARTICLE

	Larghezza Width	Profondità Depth	Altezza Height	Colore Color	Codice a barre Barcode
<b>PA56PV/F</b>	600	61	13		8010693123636
<b>PA56PV/M</b>	600	61	13		8010693123643
<b>PA56PGC/F</b>	600	61	13		8010693123872
<b>PA56PGC/M</b>	600	61	13		8010693123889
<b>PA56PMS/F</b>	600	61	13		8010693123612
<b>PA56PMS/M</b>	600	61	13		8010693123629
<b>PA56PB/F</b>	600	61	13		8010693123896
<b>PA56PB/M</b>	600	61	13		8010693123902
<b>PA56PGS/F</b>	600	61	13		8010693123858
<b>PA56PGS/M</b>	600	61	13		8010693123865

## IMBALLO / PACKING

Pz. Pc.	Tipo Type	Larghezza Width	Profondità Depth	Altezza Height
10	sacchetto/bag	130	61	600
10	sacchetto/bag	130	61	600
10	sacchetto/bag	130	61	600
10	sacchetto/bag	130	61	600
10	sacchetto/bag	130	61	600
10	sacchetto/bag	130	61	600
10	sacchetto/bag	130	61	600
10	sacchetto/bag	130	61	600
10	sacchetto/bag	130	61	600
10	sacchetto/bag	130	61	600

Tutte le misure sono espresse in millimetri / All measures are in millimeters

# Linea **FLEXTILE**

Le piastrelle FlexTile sono utilizzate, oltre che negli spogliatoi e nelle palestre, per bordare le piscine e le aree di passaggio pedonale che altrimenti risulterebbero scivolose. Sono dotate di ganci per poterle unire rapidamente ed essere eventualmente smontate con altrettanta rapidità a fine stagione. Possono essere tagliate per rifinire al meglio la pavimentazione.

*The floor tiles FlexTile are the ideal for workshops clothing, sport centers and also for pool sides and pedestrian walkways that can be slippery. They have hooks to link them quickly and to disassembly them easily at the end of the season. You can cut them to better finish the floor.*



# > Linea **FLEXTILE**

Prodotto italiano ecosostenibile  
Eco-sustainable italian product



prodotto in  
LDPE  
produced in  
LDPE



non assorbe  
gli odori  
odor-proof



non trattiene  
umidità  
doesn't retain  
humidity



semplice sistema  
di assemblaggio  
easy assembly  
system



**FTB/6**

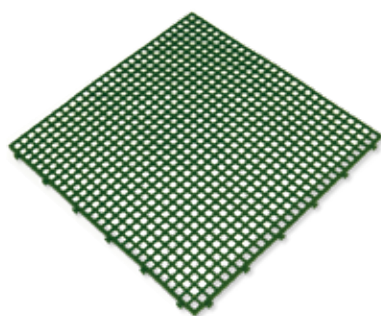

**FTV/6**

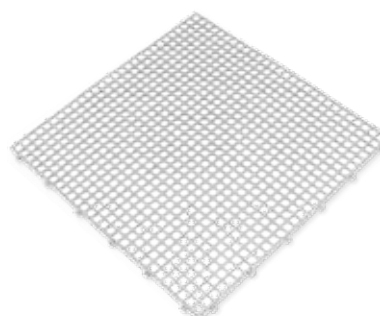

**FTW/6**

## ARTICOLO / ARTICLE

	Larghezza Width	Profondità Depth	Altezza Height	Codice a barre Barcode
<b>FTV/6</b>	400	400	8	8010693085705
<b>FTB/6</b>	400	400	8	8010693085804
<b>FTW/6</b>	400	400	8	8010693085606

## IMBALLO / PACKING

Pz. Pc.	Tipo Type	Larghezza Width	Profondità Depth	Altezza Height
1	Film termoretrato Shrunked film	400	400	50
1	Film termoretrato Shrunked film	400	400	50
1	Film termoretrato Shrunked film	400	400	50

Tutte le misure sono espresse in millimetri / All measures are in millimeters

## Linea **ROMBO**

Rombo é una piastrella tecnica ad alta capacità drenante. Ideale per ambienti in cui sono presenti liquidi (acqua, solventi, oli) o piccoli particolari di scarto (residui di torniture, peli, legno). Particolarmente consigliato per bordi piscina e docce, officine e macchine utensili, percorsi pedonali, bagni industriali, applicazioni termosanitarie.

*Rombo is a high-drainage technical tile. It is suitable to be positioned in all those places where there are liquid (water, oils, solvents) or small scrap parts by machining (metal shavings, shear waste, wood). Especially recommended for pool and showers edges, workshops and machine tools, walkways, industrial baths, thermo-sanitary applications.*



# > Linea **ROMBO**

Prodotto italiano ecosostenibile  
Eco-sustainable italian product



prodotto in polipropilene  
produced in polypropylene



non assorbe gli odori  
odor-proof



non trattiene umidità  
doesn't retain humidity



semplice sistema di assemblaggio  
easy assembly system

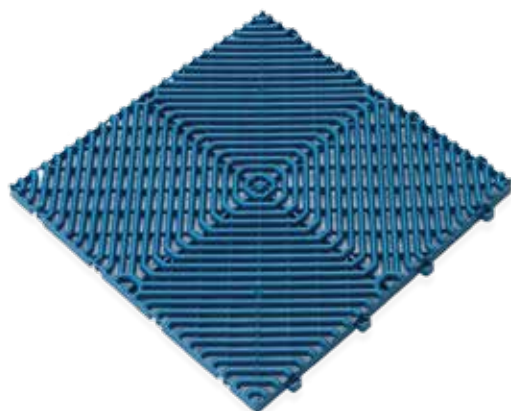
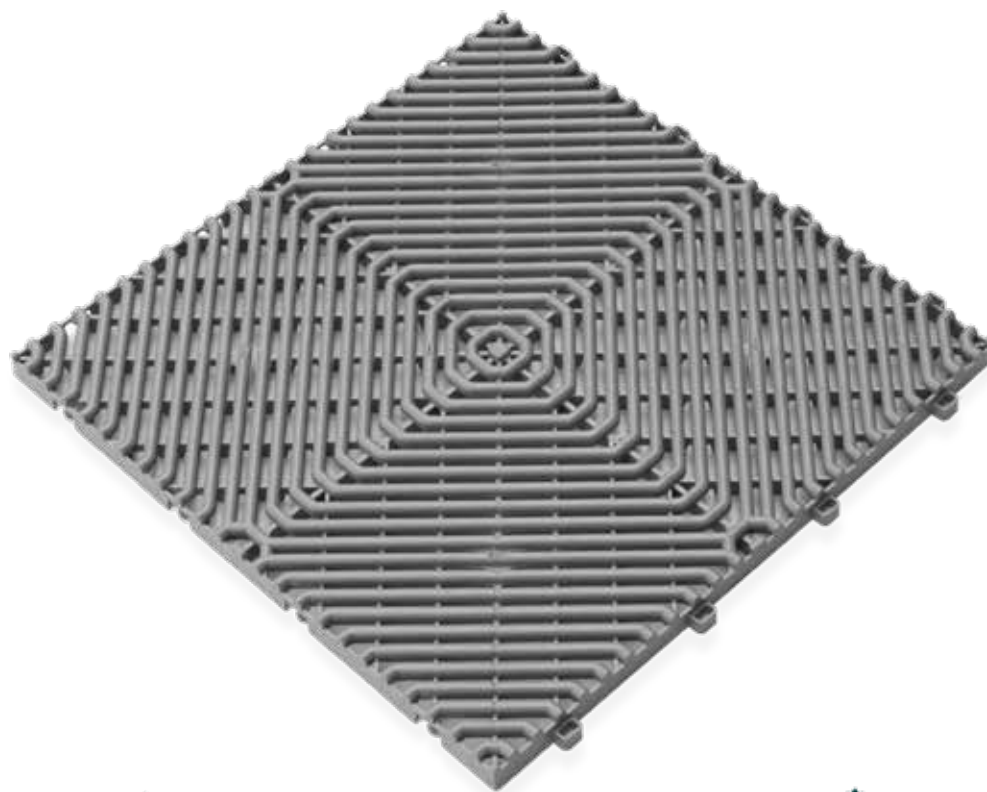

**P39B**

**P39G**

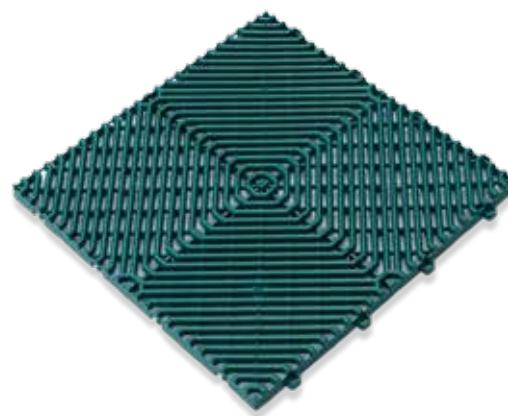

**P39V**

## ARTICOLO / ARTICLE

	Larghezza Width	Profondità Depth	Altezza Height	Codice a barre Barcode
<b>P39B</b>	395	395	17	8010693101580
<b>P39G</b>	395	395	17	8010693105465
<b>P39V</b>	395	395	17	8010693114771

## IMBALLO / PACKING

Pz. Pc.	Tipo Type	Larghezza Width	Profondità Depth	Altezza Height
10	cartone/carton	408	408	180
10	cartone/carton	408	408	180
10	cartone/carton	408	408	180

Tutte le misure sono espresse in millimetri / All measures are in millimeters

Linea  
**SALVAPRATO**

PRODOTTO  
**BREVETTATO**

Archetti che consentono di posizionare cavi elettrici, tubi per l'irrigazione, sensori intrusione ma anche resistenze anti-ghiaccio.

*Arches that allow you to position electrical cables, irrigation pipes, intrusion sensors but also anti-ice resistances.*

Questa griglia salvaprato rende percorribili dalle auto le zone verdi mantenendo inalterato il manto erboso. È la soluzione ideale per parcheggi e zone di passaggio dei giardini dove si vuole salvaguardare il verde.

*Using this grass mat grill you can run with your car on the green areas, maintaining the green unchanged. It is the best solution for parkings and walkways where you want to safeguard the green.*



# > Linea **SALVAPRATO**

Prodotto italiano ecosostenibile  
Eco-sustainable italian product



prodotto in polipropilene  
produced in polypropylene



non assorbe gli odori  
odor-proof



non trattiene umidità  
doesn't retain humidity



semplice sistema di assemblaggio  
easy assembly system

**PRODOTTO BREVETTATO**

FLOORING

Attraversabili anche da autovetture, con pavimentazione montata in piano  
*Even crossing by cars, if the floor is laying on a flat surface*

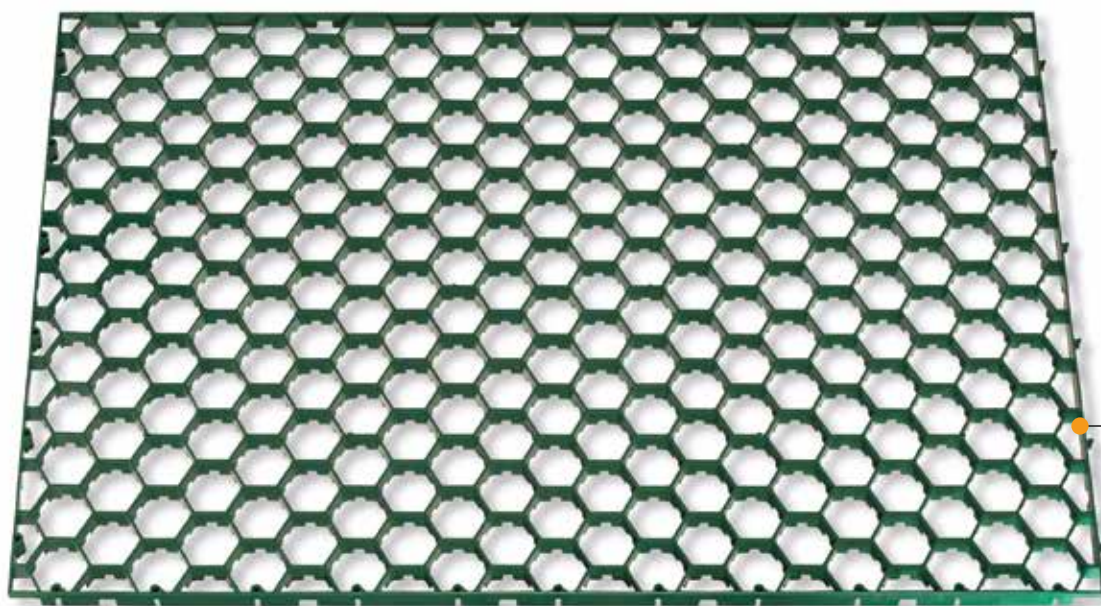

Robusti agganci laterali  
*Robust side hooks*

**P115V**



Salvaprato  
*Grass mat saver*



Salvaghiaia  
*Gravel saver*



Salvasabbia  
*Sand saver*



Sistema di imballo salvaspazio brevettato  
*Space-saver System*

## ARTICOLO / ARTICLE

Larghezza Width	Profondità Depth	Altezza Height	Codice a barre Barcode
1150	750	30	8010693119738

**P115V**

## IMBALLO / PACKING

Pz. Pc.	Tipo Type	Larghezza Width	Profondità Depth	Altezza Height
40	bancale/pallet	800	1200	1250

Tutte le misure sono espresse in millimetri / All measures are in millimeters

# Linea **PREMIUM**

## **Caratteristiche principali** *Main features*

- **Realizzata in polipropilene copolimero, materiale antiurto, impermeabile e resistente alle basse e alte temperature**  
*Produced in polypropylene copolymer, shockproof, waterproof material, resistant to low and high temperatures*
- **Prodotta con materiale riciclabile, privo di metalli pesanti e adeguata alle normative vigenti**  
*Made with recyclable material, free of heavy metals and appropriate to current regulations*
- **Lavabile, non assorbe odori e non trattiene l'umidità**  
*Washable, do not absorb odors and do not retain moisture*
- **Colore stabile e duraturo**  
*Stable and durable color*
- **Superficie antiscivolo e design con effetto ottico chiaro/scuro**  
*Non-slip surface and design with light / dark optical effect*
- **Garantita 5 anni**  
*5 years guaranteed*

# > Linea **PREMIUM**

Prodotto italiano ecosostenibile  
Eco-sustainable italian product



prodotto in polipropilene  
produced in polypropylene



non assorbe gli odori  
odor-proof



non trattiene umidità  
doesn't retain humidity



semplice sistema di assemblaggio  
easy assembly system

**PRODOTTO BREVETTATO**

FLOORING

**P75GS**

**P75W**



**Colori personalizzati su richiesta**

*Custom colors on request*

**PS75GS**



**PS75W**

Carrabile e idonea anche per le carrozzine

*Carriageable and suitable for wheelchairs*

La struttura permette il passaggio di tubi o cavi sotto la stessa

*The structure allows the passage of tubes or cables under the same*

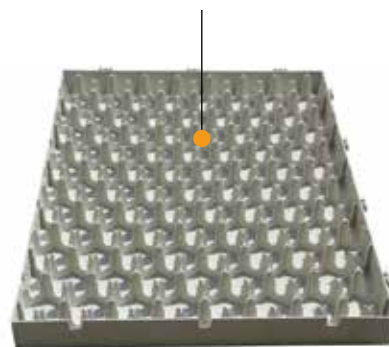

## ARTICOLO / ARTICLE

	Larghezza Width	Profondità Depth	Altezza Height	Codice a barre Barcode
<b>P75W</b>	1000	750	80	8010693118496
<b>PS75W</b>	250	500	80	8010693118564
<b>P75GS</b>	1000	750	80	8010693121755
<b>PS75GS</b>	250	500	80	8010693118632

## IMBALLO / PACKING

Pz. Pc.	Tipo Type	Larghezza Width	Profondità Depth	Altezza Height
22	pallet/pallet	800	1200	1200
2	sacchetto/plastic bag	250	500	160
22	pallet/pallet	800	1200	1200
2	sacchetto/plastic bag	250	500	160

Tutte le misure sono espresse in millimetri / All measures are in millimeters



Esempi di pedana  
espositiva personalizzata  
all'interno di un negozio

*Examples of customized  
display platform inside a store*



# > Linea **PREMIUM**

Prodotto italiano ecosostenibile  
Eco-sustainable italian product



prodotto in polipropilene  
produced in polypropylene



non assorbe gli odori  
odor-proof



non trattiene umidità  
doesn't retain humidity



semplice sistema di assemblaggio  
easy assembly system

**PRODOTTO BREVETTATO**



Esempi di allestimento pedane espositive

*Examples of setting up display platforms*

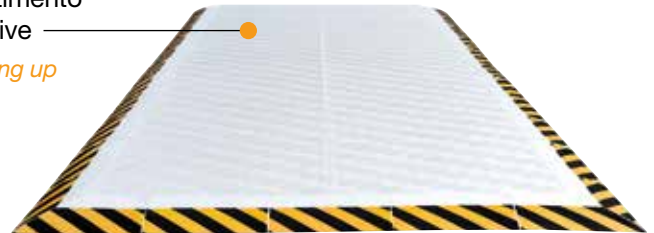

Esempi di allestimento pedane espositive

*Examples of setting up display platforms*

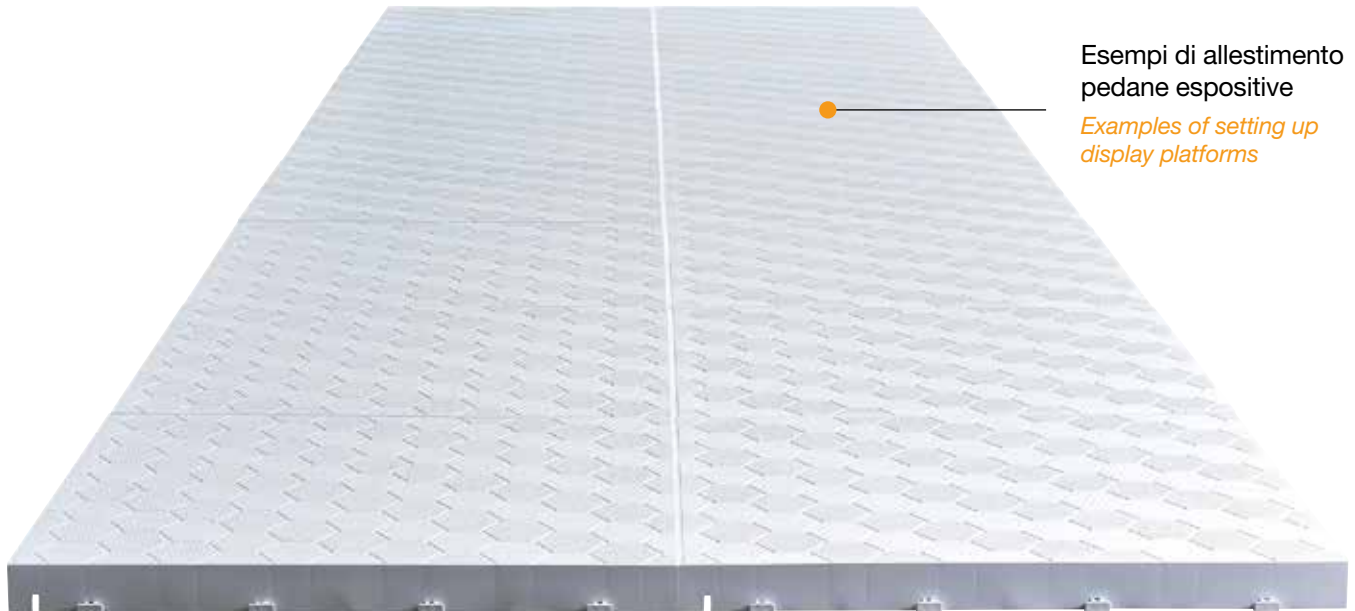

Incastro per aggancio pedane e rampe

*Interlocking for coupling platforms and ramps*

Sistema di imballo salvaspazio brevettato

*Space-saver System*



Particolare incastro

*Interlocking detail*



Pallet 80x100cm

Tutte le misure sono espresse in millimetri / All measures are in millimeters

# Linea **CUCCE**

Le Cucce con la loro forma a casetta sono gradevoli e pratiche. Hanno prese d'aria laterali, si possono smontare e lavare con comodità anche internamente. Il tetto è spiovente garantisce il naturale deflusso dell'acqua.

*The Kennels with their form of a house are enjoyable and practical. They have side vents and you can dismantle and wash their inner parts easily. The roof is drooping to allow the drainage of rainwater.*



Evita accumuli  
d'acqua  
*Dripping off  
system*

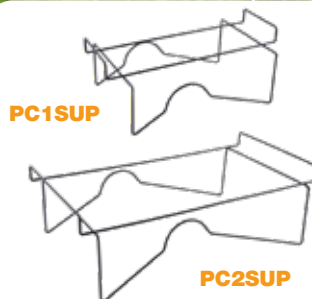

Supporti in metallo per  
esposizione cucce

*Metal supports for  
kennels display*

**Esempio di esposizione cucce  
grazie ai supporti in metallo**

*Example of kennels display with  
metal supports*



# > Linea **CUCCE**

Prodotto italiano ecosostenibile  
Eco-sustainable italian product



prodotto in polipropilene  
produced in polypropylene



non assorbe gli odori  
odor-proof



non trattiene umidità  
doesn't retain humidity



semplice sistema di assemblaggio  
easy assembly system



**PC2T**



**PC1T**



**PC3T**

## ARTICOLO / ARTICLE

	Larghezza Width	Profondità Depth	Altezza Height	Codice a barre Barcode
<b>PC1T</b>	573	394	418	8010693117055
<b>PC2T</b>	790	592	608	8010693117062
<b>PC3T</b>	978	778	743	8010693117079
<b>PC1SUP</b>	455	265	165	8010693117611
<b>PC2SUP</b>	620	340	210	8010693117628

## IMBALLO / PACKING

Pz. Pc.	Tipo Type	Larghezza Width	Profondità Depth	Altezza Height
1	sfuso/bulk	573	394	418
1	sfuso/bulk	790	592	608
1	sfuso/bulk	978	778	743
1	sfuso/bulk	455	265	165
1	sfuso/bulk	620	340	210

Tutte le misure sono espresse in millimetri / All measures are in millimeters

Linea  
**TRASPORTINI**

Maniglie integrate  
nella struttura  
*Integrated carrying  
handles*

Chiusura con scatto  
*Snap closure*

Ganci a scatto  
*Side-snap hooks*



# > Linea **TRASPORTINI**

Prodotto italiano ecosostenibile  
Eco-sustainable italian product



prodotto in polipropilene  
produced in polypropylene



non assorbe gli odori  
odor-proof



non trattiene umidità  
doesn't retain humidity



semplice sistema di assemblaggio  
easy assembly system



**PT80T**



**PT90T**



**PT100T**

## ARTICOLO / ARTICLE

	Larghezza Width	Profondità Depth	Altezza Height	Codice a barre Barcode
<b>PT80T</b>	760	450	540	8010693117475
<b>PT90T</b>	880	520	620	8010693117482
<b>PT100T</b>	990	600	680	8010693117499

## IMBALLO / PACKING

Pz. Pc.	Tipo Type	Larghezza Width	Profondità Depth	Altezza Height
1	sfuso/bulk	760	450	540
1	sfuso/bulk	880	520	620
1	sfuso/bulk	990	600	680

Tutte le misure sono espresse in millimetri / All measures are in millimeters

# > Linea **TRASPORTINI**



prodotto in polipropilene  
produced in polypropylene



non assorbe gli odori  
odor-proof



non trattiene umidità  
doesn't retain humidity



semplice sistema di assemblaggio  
easy assembly system

Maniglia integrata  
*Integrated carrying handle*

Blocco-sblocco chiusura grata  
*Lock-unlock closing-grill*



**PT50**

Blocco-sblocco trasportino  
*Lock-unlock dog carrier*



L'imballo espositore comprende:  
4 art. azzurro  
5 art. verde  
5 art. rosso

*Packagin display includes:*  
4 art. light blue  
5 art. green  
5 art. red

## ARTICOLO / ARTICLE

Larghezza Width	Profondità Depth	Altezza Height	Codice a barre Barcode
480	310	330	8010693117673

**PT50**

## IMBALLO / PACKING

Pz. Pc.	Tipo Type	Larghezza Width	Profondità Depth	Altezza Height
14	scatola/box	315	485	760

Tutte le misure sono espresse in millimetri / All measures are in millimeters

# > CIOTOLE

Prodotto italiano ecosostenibile  
Eco-sustainable italian product



prodotto in  
polipropilene  
produced in  
polypropylene



non assorbe  
gli odori  
odor-proof



non trattiene  
umidità  
doesn't retain  
humidity



**PM01/TO**

**PM01/E**



**PM02/E**

**PM02/TO**



**PM03/E**

**PM03/TO**

## ARTICOLO / ARTICLE

	Diametro Diameter	Colore Color	Altezza Height	Codice a barre Barcode
<b>PM01/TO</b>	180		58	8010693121137
<b>PM01/E</b>	180		58	8010693121809
<b>PM02/TO</b>	220		67	8010693121144
<b>PM02/E</b>	220		67	8010693121816
<b>PM03/TO</b>	255		77	8010693121151
<b>PM03/E</b>	255		77	8010693121823

## IMBALLO / PACKING

Pz. Pc.	Tipo Type	Diametro Diameter	Altezza Height
10	sacchetto/plastic bag	185	178
10	sacchetto/plastic bag	185	178
10	sacchetto/plastic bag	225	148
10	sacchetto/plastic bag	225	148
10	sacchetto/plastic bag	260	227
10	sacchetto/plastic bag	260	227

Tutte le misure sono espresse in millimetri / All measures are in millimeters

Linea  
**PETBOX**



# > Linea **PETBOX**

Prodotto italiano ecosostenibile  
Eco-sustainable italian product



prodotto in polipropilene  
produced in polypropylene



non assorbe gli odori  
odor-proof



non trattiene umidità  
doesn't retain humidity



semplice sistema di assemblaggio  
easy assembly system



Sistema di chiusura antiribaltamento

*Anti-tipping closure system*



L 10

**PM10/E**



L 39

**PM35/E**

## ARTICOLO / ARTICLE

	Larghezza Width	Profondità Depth	Altezza Height	Codice a barre Barcode
<b>PM10/E</b>	237	240	300	8010693121038
<b>PM35/E</b>	400	305	510	8010693121021

## IMBALLO / PACKING

Pz. Pc.	Tipo Type	Larghezza Width	Profondità Depth	Altezza Height
15	cartone/carton	325	235	945
6	cartone/carton	383	396	760

Tutte le misure sono espresse in millimetri / All measures are in millimeters

NEW! NEW! NEW! NEW! NEW!

## HARD TOP ALVEOLARE

Durevole e versatile, la pensilina Hard Top è progettata per assicurare solidità, resistenza alle intemperie e ai segni del tempo. Prodotto in polipropilene, questo articolo è impermeabile e con una tettoia in policarbonato anti-uv, inoltre il kit di assemblaggio al suo interno permette una rapida installazione.

*Durable and versatile, the Hard Top shelter is designed to ensure strength, resistance to weather and signs of time. Made of polypropylene, this article is waterproof and with a polycarbonate canopy anti-uv, also the assembly kit inside allows a quick installation.*

# > HARD TOP ALVEOLARE

## Serie rinforzata - Componibile

Prodotto italiano ecosostenibile  
Eco-sustainable italian product



prodotto in polipropilene  
produced in polypropylene



non assorbe gli odori  
odor-proof



non trattiene umidità  
doesn't retain humidity



semplice sistema di assemblaggio  
easy assembly system

Disponibili su 2 colorazioni  
2 shades available



Alveolare Trasparente  
Alveolar Transparent

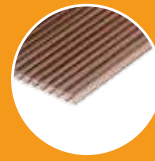

Alveolare Fumè  
Alveolar Smoked

245 mm  
9,64 in



**PE50100T**



**PE50120F**

**Pensilina Componibile**

**Rinforzata**



Predisposizione rinforzo  
2 viti verticali e 1 orizzontale



**Tutte le nostre pensiline Hard Top sono componibili lateralmente e sul retro.**

*All our canopies Hard Top are modular on the side and on the back.*

# > HARD TOP ALVEOLARE

## Serie rinforzata - Componibile



prodotto in polipropilene  
produced in polypropylene



non assorbe gli odori  
not absorb odors



non trattiene umidità  
doesn't retain humidity



semplice sistema di assemblaggio  
easy assembly system

Disponibili su 2 colorazioni  
2 shades available

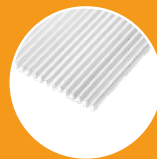

Alveolare Trasparente  
Alveolar Transparent

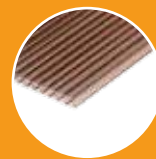

Alveolare Fumè  
Alveolar Smoked



**PE80100T**



**PE80120F**

**Tutte le nostre pensiline Hard Top sono componibili lateralmente e sul retro.**

*All our canopies Hard Top are modular on the side and on the back.*

### ARTICOLO / ARTICLE

Profondità Depth	Larghezza Width	Colore Color	Codice a barre Barcode
<b>PE50100T</b>	500	1000	8010693124695
<b>PE50100F</b>	500	1000	8010693124756
<b>PE50120T</b>	500	1200	8010693125135
<b>PE50120F</b>	500	1200	8010693125142
<b>PE80100T</b>	800	1000	8010693124701
<b>PE80100F</b>	800	1000	8010693124763
<b>PE80120T</b>	800	1200	8010693124718
<b>PE80120F</b>	800	1200	8010693124770

### IMBALLO / PACKING

Pz. Pc.	Tipo Type	Larghezza Width	Profondità Depth	Altezza Height
1	cartone/carton	500	1000	70/15
1	cartone/carton	500	1000	70/15
1	cartone/carton	500	1017	70/15
1	cartone/carton	500	1017	70/15
1	cartone/carton	800	1165	70/15
1	cartone/carton	800	1165	70/15
1	cartone/carton	800	1165	70/15
1	cartone/carton	800	1165	70/15

Tutte le misure sono espresse in millimetri / All measures are in millimeters



# > HARD TOP ALVEOLARE

## Serie rinforzata - Componibile

Prodotto italiano ecosostenibile  
Eco-sustainable italian product



prodotto in polipropilene  
produced in polypropylene



non assorbe gli odori  
not absorb odors



non trattiene umidità  
doesn't retain humidity



semplice sistema di assemblaggio  
easy assembly system

Disponibili su 2 colorazioni  
2 shades available



Alveolare Trasparente  
Alveolar Transparent



Alveolare Fumè  
Alveolar Smoked

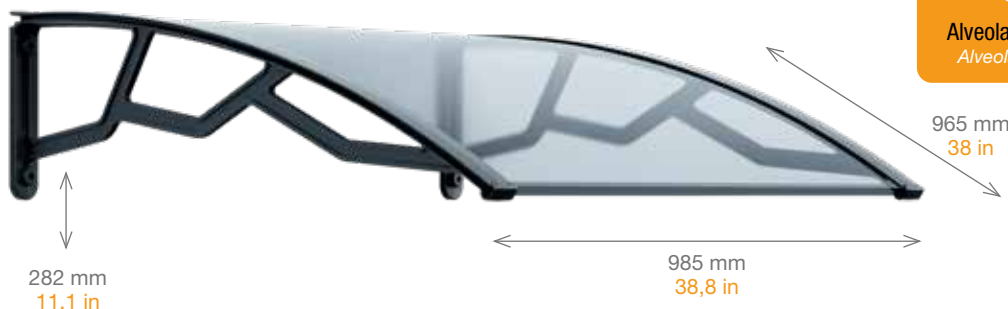

**PE100100T**



**PE100120F**

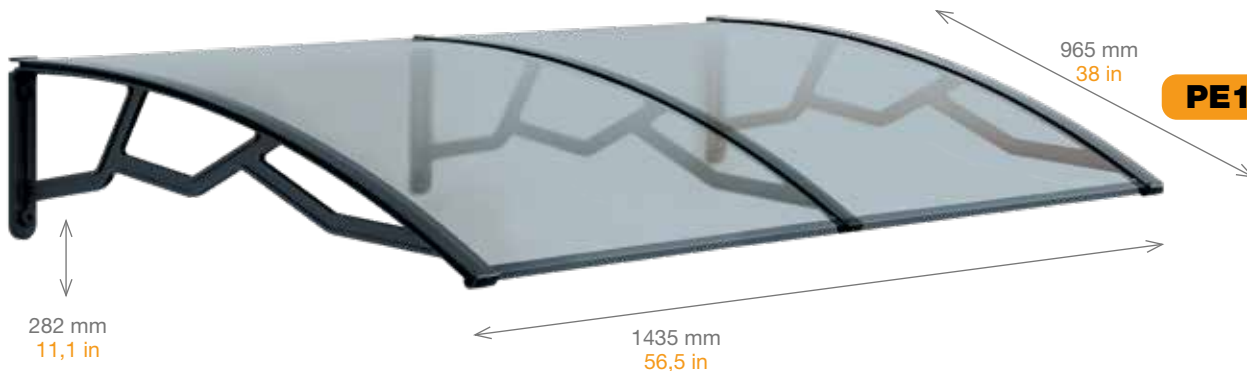

**PE100145T**

**Tutte le nostre pensiline Hard Top sono componibili lateralmente e sul retro.**

*All our canopies Hard Top are modular on the side and on the back.*

### ARTICOLO / ARTICLE

### IMBALLO / PACKING

	Profondità Depth	Larghezza Width	Colore Color	Codice a barre Barcode	Pz. Pc.	Tipo Type	Larghezza Width	Profondità Depth	Altezza Height
<b>PE100100T</b>	1000	1000		8010693125159	1	cartone/carton	1000	1116	70/15
<b>PE100100F</b>	1000	1000		8010693125166	1	cartone/carton	1000	1116	70/15
<b>PE100120T</b>	1000	1200		8010693124725	1	cartone/carton	1020	1165	70/15
<b>PE100120F</b>	1000	1200		8010693124787	1	cartone/carton	1020	1165	70/15
<b>PE100145T</b>	1000	1450		8010693125173	1	cartone/carton	700	1000	70
<b>PE100145F</b>	1000	1450		8010693125180	1	cartone/carton	700	1000	70

Tutte le misure sono espresse in millimetri / All measures are in millimeters

NEW! NEW! NEW! NEW! NEW!

# HARD TOP ALVEOLARE

# > HARD TOP ALVEOLARE

## Serie rinforzata - Componibile

Prodotto italiano ecosostenibile  
Eco-sustainable italian product



prodotto in polipropilene  
produced in polypropylene



non assorbe gli odori  
not absorb odors



non trattiene umidità  
doesn't retain humidity



semplice sistema di assemblaggio  
easy assembly system

Disponibili su 2 colorazioni  
2 shades available

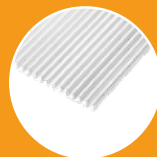

Alveolare Trasparente  
Alveolar Transparent

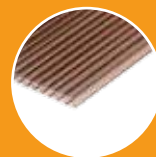

Alveolare Fumè  
Alveolar Smoked



1180 mm  
46,5 in

1793 mm  
70,6 in

**PE120180F**

303 mm  
11,9 in

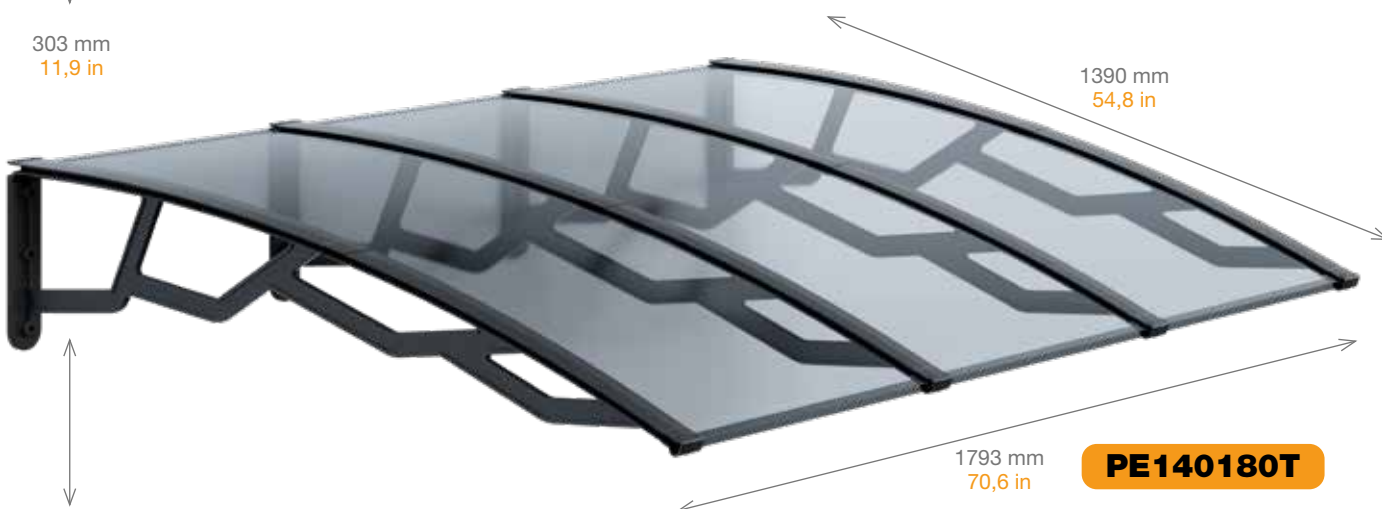

1390 mm  
54,8 in

1793 mm  
70,6 in

**PE140180T**

303 mm  
11,9 in

**Tutte le nostre pensiline Hard Top sono componibili lateralmente e sul retro.**

*All our canopies Hard Top are modular on the side and on the back.*

### ARTICOLO / ARTICLE

### IMBALLO / PACKING

	Profondità Depth	Larghezza Width	Colore Color	Codice a barre Barcode	Pz. Pc.	Tipo Type	Larghezza Width	Profondità Depth	Altezza Height
<b>PE120180T</b>	1200	1800		8010693125197	1	cartone/carton	700	1200	150
<b>PE120180F</b>	1200	1800		8010693125210	1	cartone/carton	700	1200	150
<b>PE140180T</b>	1400	1800		8010693125203	1	cartone/carton	700	1400	150
<b>PE140180F</b>	1400	1800		8010693125227	1	cartone/carton	700	1400	150

Tutte le misure sono espresse in millimetri / All measures are in millimeters

NEW! NEW! NEW!  
NEW! NEW! NEW!  
NEW! NEW! NEW!

# HARD TOP COMPATTO



# > HARD TOP COMPATTO

## Serie rinforzata - Componibile

Prodotto italiano ecosostenibile  
Eco-sustainable italian product



prodotto in polipropilene  
produced in polypropylene



non assorbe gli odori  
odor-proof



non trattiene umidità  
doesn't retain humidity



semplice sistema di assemblaggio  
easy assembly system



**PE50100C**



**PE50120C**



**PE80100C**

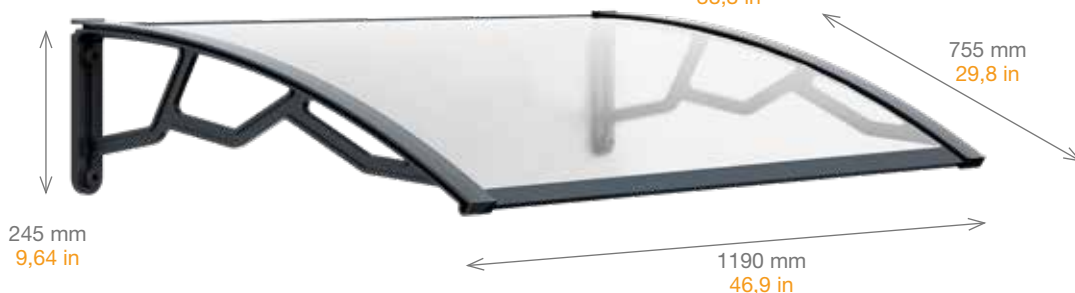

**PE80120C**

### ARTICOLO / ARTICLE

	Profondità Depth	Larghezza Width	Codice a barre Barcode
<b>PE50100C</b>	500	1000	8010693124817
<b>PE50120C</b>	500	1200	8010693125234
<b>PE80100C</b>	800	1000	8010693124824
<b>PE80120C</b>	800	1200	8010693124831

### IMBALLO / PACKING

Pz. Pc.	Tipo Type	Larghezza Width	Profondità Depth	Altezza Height
1	cartone/carton	500	1000	70/15
1	cartone/carton	500	1117	70/15
1	cartone/carton	800	1165	70/15
1	cartone/carton	800	1165	70/15

Tutte le misure sono espresse in millimetri / All measures are in millimeters

# > **HARD TOP COMPATTO**

**Serie rinforzata - Componibile**

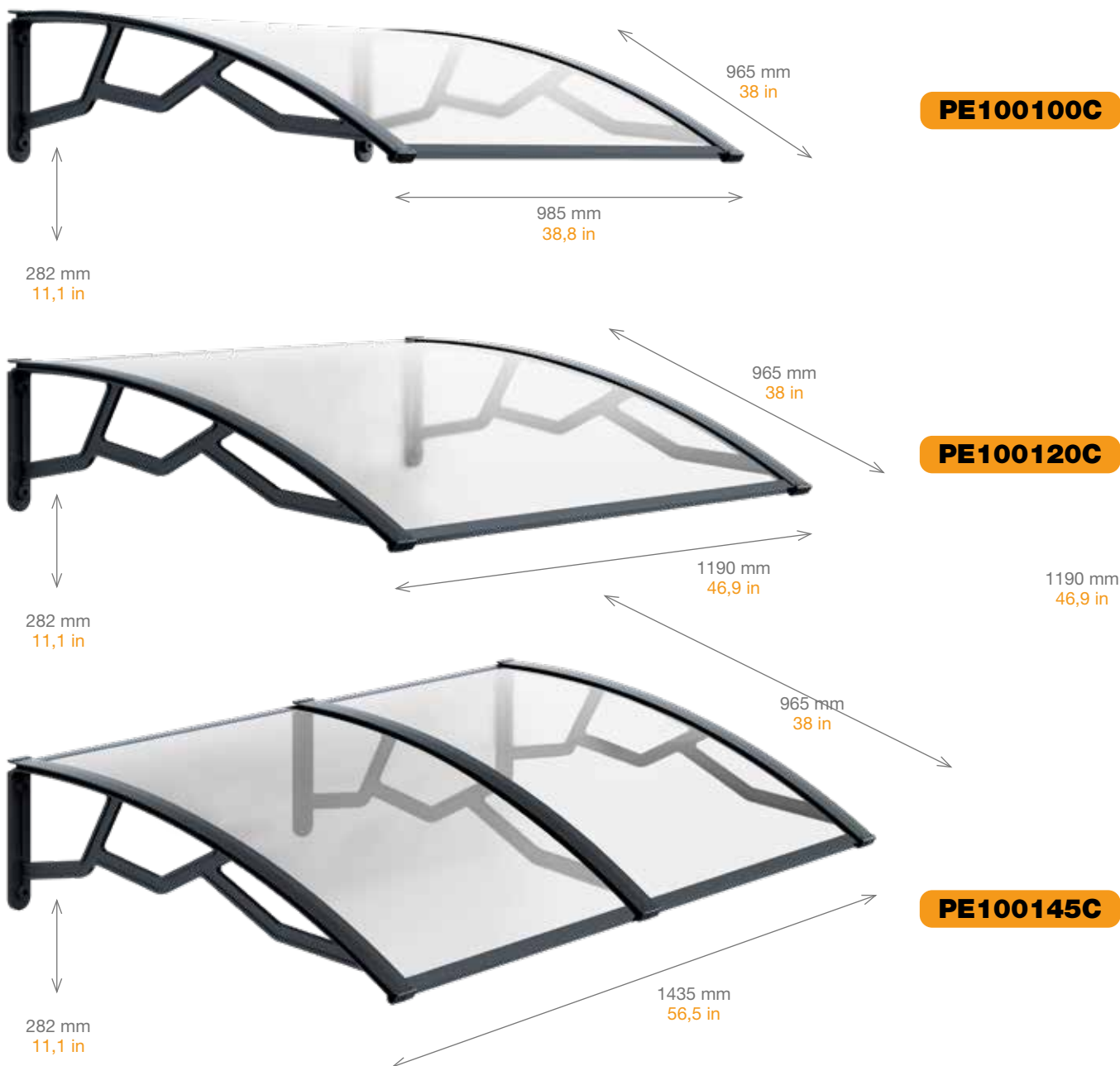

**Tutte le nostre pensiline Hard Top sono componibili lateralmente e sul retro.**

*All our canopies Hard Top are modular on the side and on the back.*

## ARTICOLO / ARTICLE

Profondità Depth	Larghezza Width	Codice a barre Barcode
<b>PE100100C</b>	1000	8010693125241
<b>PE100120C</b>	1200	8010693124848
<b>PE100145C</b>	1450	8010693125258

## IMBALLO / PACKING

Pz. Pc.	Tipo Type	Larghezza Width	Profondità Depth	Altezza Height
1	cartone/carton	1000	1116	70/15
1	cartone/carton	1020	1165	70/15
1	cartone/carton	700	1000	70

Tutte le misure sono espresse in millimetri / All measures are in millimeters



prodotto in polipropilene  
produced in polypropylene



non assorbe gli odori  
odor-proof



non trattiene umidità  
doesn't retain humidity



semplice sistema di assemblaggio  
easy assembly system

Prodotto italiano ecosostenibile  
Eco-sustainable italian product

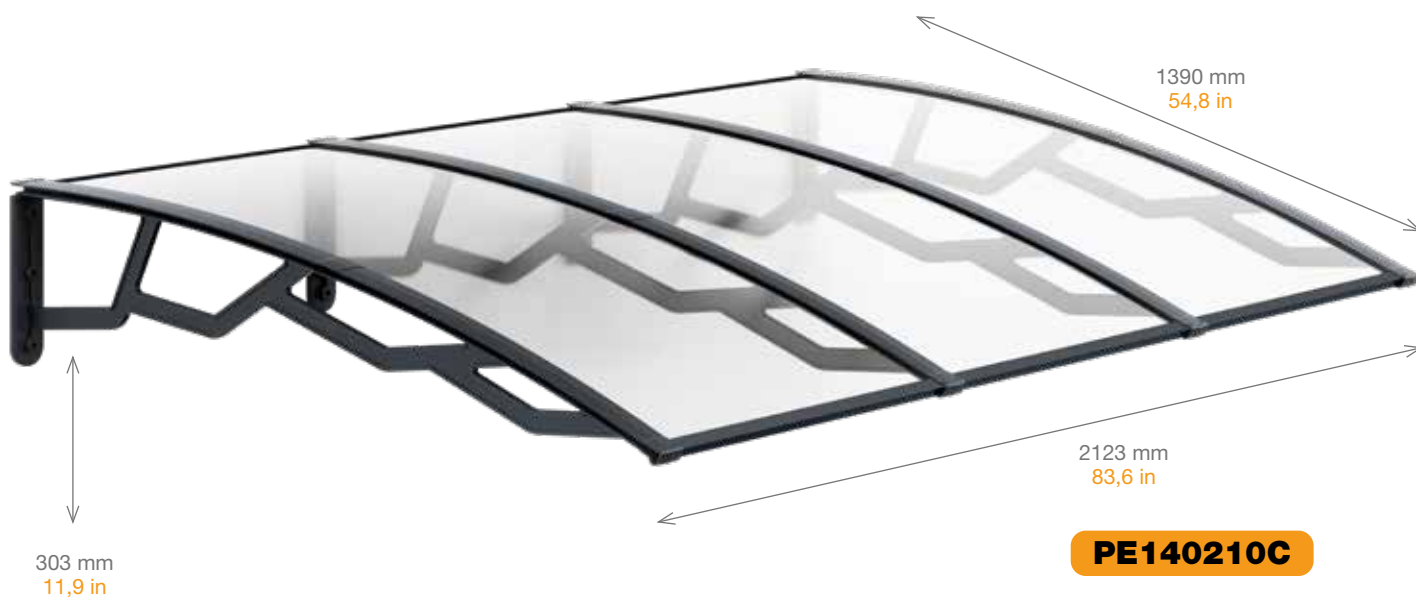

**Tutte le nostre pensiline Hard Top sono componibili lateralmente e sul retro.**

*All our canopies Hard Top are modular on the side and on the back.*

**ARTICOLO / ARTICLE**

Profondità Depth	Larghezza Width	Codice a barre Barcode	
<b>PE120210C</b>	1200	2100	8010693125265
<b>PE140210C</b>	1400	2100	8010693125272

**IMBALLO / PACKING**

Pz. Pc.	Tipo Type	Larghezza Width	Profondità Depth	Altezza Height
1	cartone/carton	700	1200	150
1	cartone/carton	700	1400	150

Tutte le misure sono espresse in millimetri / All measures are in millimeters

## Linea **CLEAN**

Il nostro zerbino ha un design elegante che lo rende idoneo per ogni area interna ed esterna. Perfetto per intrappolare lo sporco e l'acqua piovana, offre una protezione per case ed uffici.

*Our doormat has an elegant design that makes it suitable for any indoor and outdoor area. Perfect for trapping dirt and rainwater, it offers protection for homes and offices.*



# > ZERBINO

Prodotto italiano ecosostenibile  
Eco-sustainable italian product



prodotto in  
polipropilene  
produced in  
polypropylene



non assorbe  
gli odori  
odor-proof



non trattiene  
umidità  
doesn't retain  
humidity

GARDEN

Alta resistenza  
*High resistance*



**ZER6040A**

## ARTICOLO / ARTICLE

Larghezza Width	Profondità Depth	Altezza Height	Codice a barre Barcode
<b>ZER6040A</b> 595	395	9	8010693114764

## IMBALLO / PACKING

Pz. Pc.	Tipo Type	Larghezza Width	Profondità Depth	Altezza Height
1	sfuso/bulk	595	395	9

Tutte le misure sono espresse in millimetri / All measures are in millimeters

NEW! NEW! NEW! NEW!

Linea  
**BORDURE**

**Extrusion**

# > ECOBORDURA 6mt

Prodotto italiano ecosostenibile  
Eco-sustainable italian product



prodotto in polipropilene  
produced in polypropylene



non assorbe gli odori  
odor-proof



non trattiene umidità  
doesn't retain humidity



semplice sistema di assemblaggio  
easy assembly system

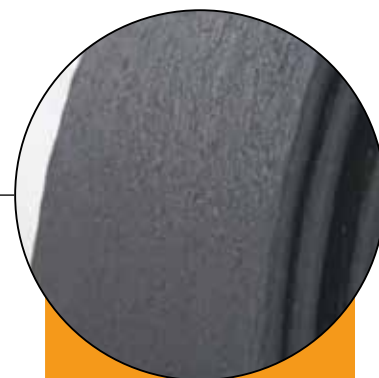

**EFFETTO PIETRA**  
Stone effect

**x5** Picchetti  
Pickets

27 mm 20 mm

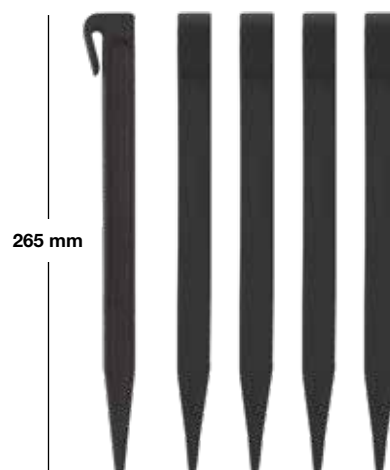

**BR06AN**



**BR06GC**



## ARTICOLO / ARTICLE

	Larghezza Width	Profondità Depth	Altezza Height	Codice a barre Barcode
<b>BR06AN</b>	6000	4	120	8010693125463
<b>BR06GC</b>	6000	4	120	8010693125470

## IMBALLO / PACKING

Pz. Pc.	Tipo Type	Larghezza / Ø Width	Profondità Depth	Altezza Height
1	cartone/carton	370	128	370
1	cartone/carton	370	128	370

Tutte le misure sono espresse in millimetri / All measures are in millimeters

NEW! NEW! NEW! NEW!

Linea  
**BORDURE**

**Picchetti**



# > PICCHETTI PER BORDURA

Prodotto italiano ecosostenibile  
Eco-sustainable italian product



prodotto in polipropilene  
produced in polypropylene



non assorbe gli odori  
odor-proof



non trattiene umidità  
doesn't retain humidity



semplice sistema di assemblaggio  
easy assembly system



## PICCHETTI DENTATI 100% IN PP RICICLATO NERO.

*Posa di un picchetto ogni 80 cm circa in funzione delle curve desiderate per una migliore stabilizzazione della bordura.*

**12 picchetti = 1 bordura da 10m\***  
*\*a seconda della forma desiderata*

**BRPIC**

### ARTICOLO / ARTICLE

Larghezza Width	Profondità Depth	Altezza Height	Codice a barre Barcode
kit 12 pz./kit 12 pcs. 150	60	380	8010693126279

### IMBALLO / PACKING

Pz. Pc.	Tipo Type	Larghezza Width	Profondità Depth	Altezza Height
30	cartone/carton	539	432	189

Tutte le misure sono espresse in millimetri / All measures are in millimeters

NEW! NEW! NEW!  
NEW! NEW! NEW!

Linea  
**BORDURE**

**Injection**

# > ECOBORDURA

Prodotto italiano ecosostenibile  
Eco-sustainable italian product



prodotto in polipropilene  
produced in polypropylene



non assorbe gli odori  
odor-proof



non trattiene umidità  
doesn't retain humidity



semplice sistema di assemblaggio  
easy assembly system

**CONFEZIONE DA 5 PEZZI**

Pack of 5 pieces

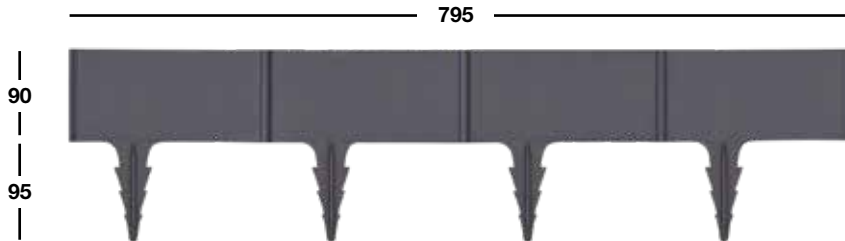

**BR01AN**



**BR01MA**

**5** pezzi  
pcs = **4** mt  
157,48 in



**INCASTRO VELOCE**  
Quick fit



**AGGANCIAMENTO PERFETTO**  
Perfect hook



**FLESSIBILE**  
Flexible

## ARTICOLO / ARTICLE

## IMBALLO / PACKING

	Larghezza Width	Profondità Depth	Altezza Height	Codice a barre Barcode	Pz. Pc.	Tipo Type	Larghezza Width	Profondità Depth	Altezza Height
<b>BR01AN</b>	kit 5 pz./kit 5 pcs. 795	25	185	8010693125906	8	cartone/carton	300	205	800
<b>BR01MA</b>	kit 5 pz./kit 5 pcs. 795	25	185	8010693126361	8	cartone/carton	300	205	800

Tutte le misure sono espresse in millimetri / All measures are in millimeters

NEW! NEW! NEW!  
NEW! NEW! NEW!

Linea  
**BORDURE**

**Injection**





# > BORDURA GRECA

Prodotto italiano ecosostenibile  
Eco-sustainable italian product



prodotto in polipropilene  
produced in polypropylene



non assorbe gli odori  
odor-proof



non trattiene umidità  
doesn't retain humidity



semplice sistema di assemblaggio  
easy assembly system

**CONFEZIONE DA 5 PEZZI**

*Pack of 5 pieces*



GARDEN

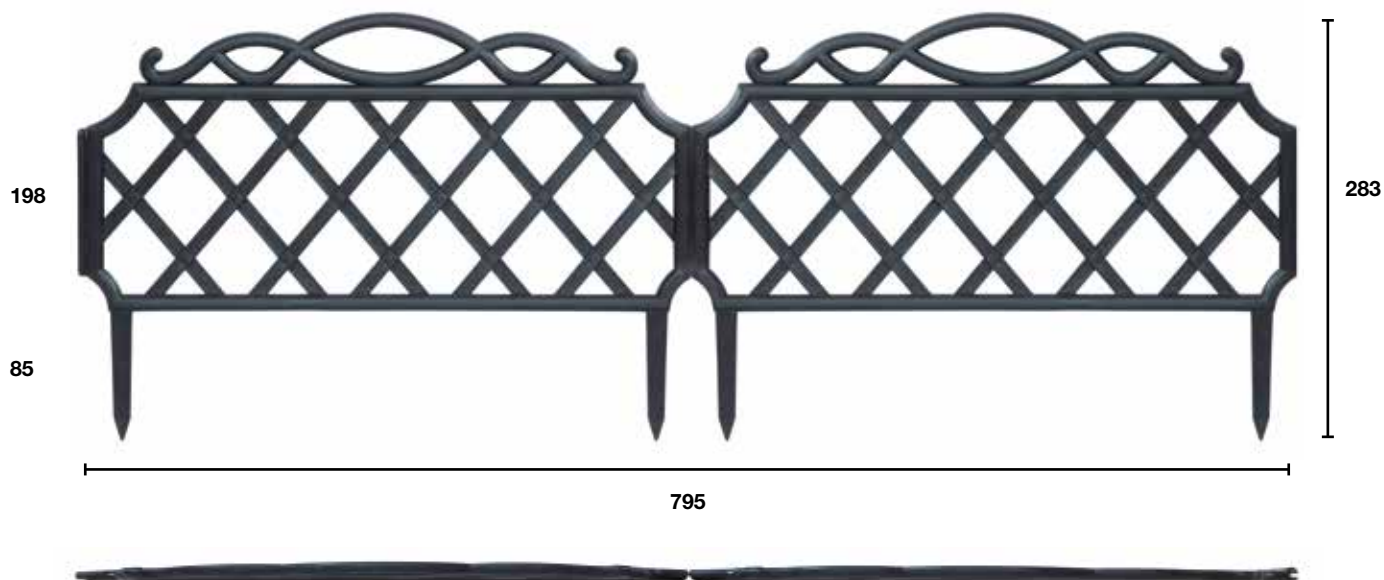

**SPESSORE 8 MM**

**BR02AN**

**FLESSIBILE**

*Flexible*



Facile da montare  
*Easy to assemble*



Resistente alle intemperie  
*Weatherproof*



Lavabile  
*Washable*



**INCASTRO VELOCE**

*Quick fit*



**AGGANCIO PERFETTO**

*Perfect hook*

**ARTICOLO / ARTICLE**

**IMBALLO / PACKING**

ARTICOLO / ARTICLE				IMBALLO / PACKING					
Larghezza Width	Profondità Depth	Altezza Height	Codice a barre Barcode	Pz. Pc.	Tipo Type	Larghezza Width	Profondità Depth	Altezza Height	
<b>BR02AN</b>	kit 5 pz./kit 5 pcs. 795 40	298	8010693126347	5	cartone/carton	300	205	800	

Tutte le misure sono espresse in millimetri / All measures are in millimeters

  
**NOVITÀ**  
New product

# Linea **GARDEN SHED**

La Casetta modulare Garden Shed mantiene pulito e in ordine il tuo giardino con capacità e design. Dotate di una struttura con pareti a doppio strato rinforzato anti-torsione. Resistente agli agenti atmosferici (eccetto gli eventi climatici più estremi) e non richiede nessuna manutenzione. Presenta 8 griglie di ventilazione, che raddoppiano ad ogni estensione applicata, rendendo l'interno sempre asciutto e protetto.

*The Modular Shed Garden Shed keeps your garden clean and tidy with capacity and design. Equipped with a structure with double layer walls reinforced anti-torsion. Weather resistant (except the most extreme weather events) and does not require any maintenance. It has 8 ventilation grilles, which double with each extension applied, making the interior always dry and protected.*

**Versione** REINFORCED VERSION  
**RINFORZATA**



**RESISTENTE AI RAGGI UV ED A PROVA DI INFILTRAZIONE**

*UV-resistant and Anti-infiltration*

**SICURA E LUCCHETTABILE**

*Safe and Lockable*

**INTERNO ED ESTERNO LAVABILE**

*Internal and external Washable*

**PAVIMENTO INCLUSO**

*Floor included*

# > GARDEN SHED

Prodotto italiano ecosostenibile  
Eco-sustainable italian product



prodotto in polipropilene  
produced in polypropylene



non assorbe gli odori  
odor-proof



non trattiene umidità  
doesn't retain humidity



semplice sistema di assemblaggio  
easy assembly system



## CASSETTA BASE

Basic Shed

**Superficie occupata** 1,25 mq  
Occupied surface

**Volume interno** 2000 L  
Inner volume



### SHEDBA/N

**PESO TOTALE 52 KG**  
Total weight 52 Kg



### SHEDBA/T

**VELOCE E FACILE DA ASSEMBLARE**  
Practical and easy to be assembled



### ARTICOLO / ARTICLE

	Larghezza Width	Profondità Depth	Altezza Height	Colore Color	Codice a barre Barcode
<b>SHEDBA/N</b>	1510	830	2000		8010693126392
<b>SHEDBA/T</b>	1510	830	2000		8010693126446

### IMBALLO / PACKING

Pz. Pc.	Tipo Type	Larghezza Width	Profondità Depth	Altezza Height
1/2	cartone/carton	1460	265	925
2/2	cartone/carton	1550	280	945
1/2	cartone/carton	1460	265	925
2/2	cartone/carton	1550	280	945

Tutte le misure sono espresse in millimetri / All measures are in millimeters

# > GARDEN SHED

Prodotto italiano ecosostenibile  
Eco-sustainable italian product



## CASETTA MEDIA

Medium Shed

**Superficie occupata**  
Occupied surface **2,20 mq**

**Volume interno**  
Inner volume **3.750 L**

## SHEDME/N



**PESO TOTALE 73,7 KG**  
Total weight 73,7 Kg



**VELOCE E FACILE DA ASSEMBLARE**  
Practical and easy to be assembled



## SHEDME/T



### ARTICOLO / ARTICLE

	Larghezza Width	Profondità Depth	Altezza Height	Colore Color	Codice a barre Barcode
<b>SHEDME/N</b>	1510	1460	2000		8010693126927
<b>SHEDME/T</b>	1510	1460	2000		8010693126934

### IMBALLO / PACKING

Pz. Pc.	Tipo Type	Larghezza Width	Profondità Depth	Altezza Height
1/3	cartone/carton	1460	265	925
2/3	cartone/carton	1550	280	945
3/3	cartone/carton	1550	280	945
1/3	cartone/carton	1460	265	925
2/3	cartone/carton	1550	280	945
3/3	cartone/carton	1550	280	945

Tutte le misure sono espresse in millimetri / All measures are in millimeters

# > GARDEN SHED

Prodotto italiano ecosostenibile  
Eco-sustainable italian product



GARDEN



## CASSETTA LARGE

Large Shed

**Superficie occupata** **3,14 mq**  
Occupied surface

**Volume interno** **5.500 L**  
Inner volume

## SHEDLA/N



**PESO TOTALE 95,4 KG**  
Total weight 95,4 Kg



**VELOCE E FACILE DA ASSEMBLARE**  
Practical and easy to be assembled



### STRUTTURA RINFORZATA ANTI-TORSIONE CON SPESSORE MEDIO 60 MM

Reinforced structure Anti-Twist  
with average thickness 60 mm



### SUPERFICE EFFETTO LEGNO

Surface with a wood effect



### 8 GRIGLIE DI VENTILAZIONE

Whit 8 Ventilation grids



## ARTICOLO / ARTICLE

	Larghezza Width	Profondità Depth	Altezza Height	Colore Color	Codice a barre Barcode
<b>SHEDLA/N</b>	1510	2080	2000		8010693126941
<b>SHEDLA/T</b>	1510	2080	2000		8010693126958

## IMBALLO / PACKING

Pz. Pc.	Tipo Type	Larghezza Width	Profondità Depth	Altezza Height
1/4	cartone/carton	1460	265	925
2/4	cartone/carton	1550	280	945
3/4	cartone/carton	1550	280	945
4/4	cartone/carton	1550	280	945

Tutte le misure sono espresse in millimetri / All measures are in millimeters

  
**NOVITÀ**  
New product

## Linea **GARDEN SHED**

Il Garden Storage è la soluzione ideale per ogni stagione, resistente, elegante e pratico si integra perfettamente nel vostro giardino. Resistente ai raggi UV e agli agenti atmosferici (eccetto gli eventi climatici più estremi). Non richiede nessuna manutenzione. Presenta 4 griglie di ventilazione che rendono l'interno sempre asciutto e protetto.

*The Garden Storage is the ideal solution for any season, durable, elegant and practical fits perfectly into your garden. Resistant to UV rays and weathering (except the most extreme climatic events). Does not require any maintenance. It has 4 ventilation grilles that make the interior always dry and protected.*

**Versione** REINFORCED  
**RINFORZATA** VERSION



**RESISTENTE AI RAGGI UV ED A PROVA DI INFILTRAZIONE**

*UV-resistant and Anti-infiltration*

**SICURA E LUCCHETTABILE**

*Safe and Lockable*

**INTERNO ED ESTERNO LAVABILE**

*Internal and external Washable*

# > GARDEN STORAGE

Prodotto italiano ecosostenibile  
Eco-sustainable italian product



prodotto in polipropilene  
produced in polypropylene



non assorbe gli odori  
odor-proof



non trattiene umidità  
doesn't retain humidity



semplice sistema di assemblaggio  
easy assembly system



**IDEALE PER RIPORRE ATTREZZI E BIDONI DELLA RACCOLTA DIFFERENZIATA**

*Ideal for storage tools and drums of separate collection*

**VELOCE E FACILE DA ASSEMBLARE**  
*Practical and easy to be assembled*



**15 min**

## SHEDSTO/N

### SUPERFICE EFFETTO LEGNO

*Surface with a wood effect*



### GRIGLIE DI VENTILAZIONE

*Ventilation grids*



**VOLUME**  
**1200 L**



### ARTICOLO / ARTICLE

	Larghezza Width	Profondità Depth	Altezza Height	Colore Color	Codice a barre Barcode
<b>SHEDSTO/N</b>	1460	870	1190		8010693126415
<b>SHEDSTO/T</b>	1460	870	1190		8010693126460

### IMBALLO / PACKING

Pz. Pc.	Tipo Type	Larghezza Width	Profondità Depth	Altezza Height
1	cartone/carton	1580	320	1025
1	cartone/carton	1580	320	1025

Tutte le misure sono espresse in millimetri / All measures are in millimeters

  
**NOVITÀ**  
New product

## Linea **INFINITY**

# INFINITY

**MULTIUSO** - Il pannello INFINITY può essere utilizzato sia per un uso professionale che casalingo, infatti è ideale per la decorazione di esterni in centri commerciali, bar, ristoranti, parchi e giardini. Grazie alla sua griglia reticolata è adatto a tutti i tipi di rampicanti a stelo lungo consentendo alle tue piante di prosperare.

**ESTENSIBILE** - il prodotto risulta essere estremamente pratico e facile da utilizzare, infatti essendo modulare, puoi adattarlo facilmente a spazi diversi in base alle proprie esigenze per ottenere la misura desiderata.

**STRUTTURA SOLIDA** - Realizzato in polipropilene rinforzato 100% rigenerato rendendo il prodotto resistente, non ammuffisce, non ospita insetti e non necessita di manutenzione.

*MULTIPURPOSE - The INFINITY panel can be used for both professional and home use, in fact it is ideal for outdoor decoration in shopping malls, bars, restaurants, parks and gardens. Thanks to its reticulated grid it is suitable for all types of long-stemmed climbers allowing your plants to thrive.*

*EXTENSIBLE - the product is extremely practical and easy to use, in fact, being modular, you can easily adapt it to different spaces according to your needs to obtain the desired size.*

*SOLID STRUCTURE - Made of reinforced polypropylene 100% regenerated making the product resistant, not mouldy, does not host insects and does not require maintenance.*

**PRODOTTO PERSONALIZZABILE**

*Customizable product*

**Scan me**



Scopri la linea  
**INFINITY**





# > PANNELLO MODULARE

Modular Fence

Prodotto italiano ecosostenibile  
Eco-sustainable italian product



**PROGETTATO PER ESSERE  
ESTENSIBILE**

*Designed to be Extensible*



**RECYCLED  
PLASTIC**

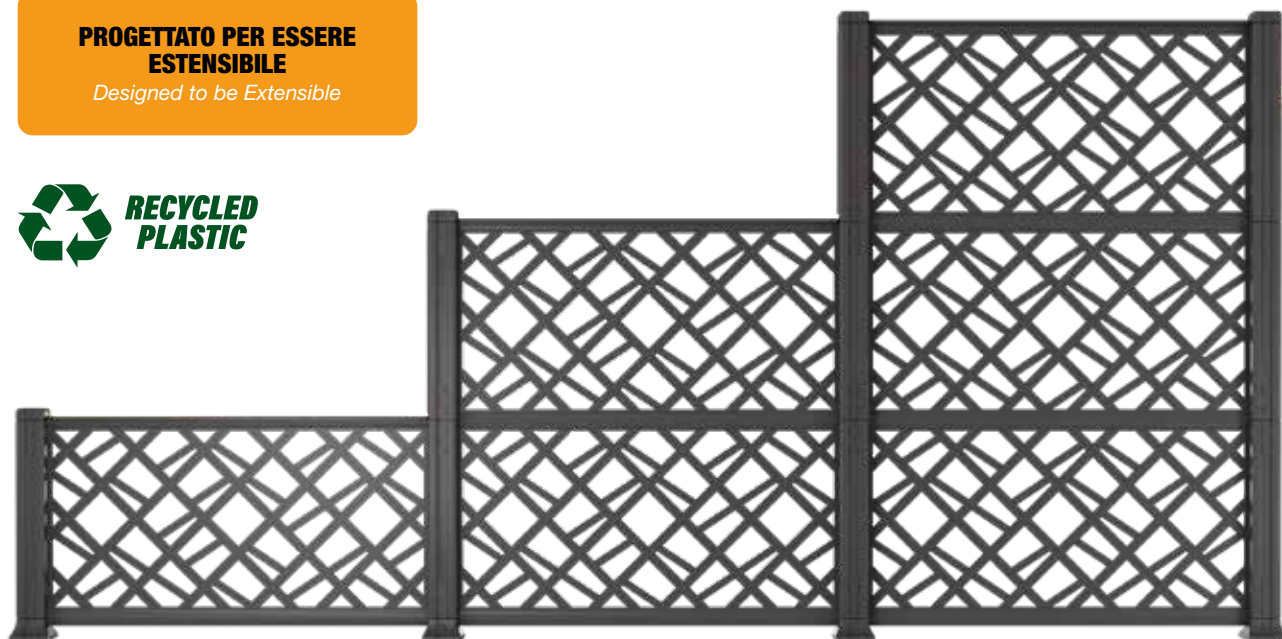

**Facile da montare**  
*Easy to assemble*



**Resistente alle intemperie**  
*Weatherproof*



**Lavabile**  
*Washable*



**Prodotto modulare**  
*Modular product*



**Veloce da assemblare**  
*Practical to assemble*

**STRUTTURA  
RINFORZATA  
ANTI-TORSIONE**

*Reinforced structure  
Anti-Twist*

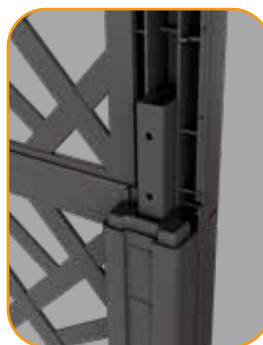

**FISSAGGIO A TERRA  
CON PIASTRE IN  
ACCIAIO**

*Fixing to the ground  
with steel plates*



**DISPONIBILE  
IN 3 COLORI**

*Available in 3 colors*



Antracite  
*Anthracite*

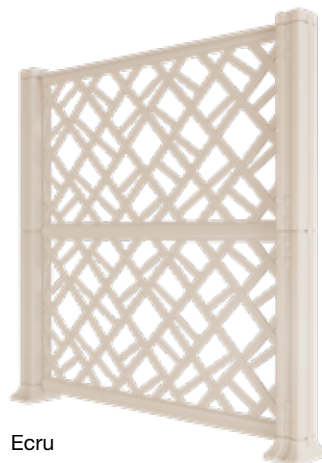

Ecru  
*Ecru*



Marrone  
*Brown*

# > PANNELLO MODULARE

## Modular Fence

Prodotto italiano ecosostenibile  
Eco-sustainable italian product



prodotto in polipropilene  
produced in polypropylene



non assorbe gli odori  
odor-proof



non trattiene umidità  
doesn't retain humidity



semplice sistema di assemblaggio  
easy assembly system

## STARTING KIT SCATOLA 050 A

**INF050AN/A**



### Kit composto da: Kit consisting of:

- 1 pannello decorativo;  
*1 decorative panel;*
- 2 pilastri rinforzati, copri piedi e profilo inferiore e superiore;  
*2 reinforced pillars, foot covers and lower and upper profiles;*
- Tappi superiori e laterali;  
*Top and lateral caps;*
- Viteria per assemblaggio e 2 staffe in acciaio per fissaggio a terra.  
*Screws for assembly and 2 steel brackets for fixing to the ground.*



### GARDEN STYLE



### COMMERCIAL ZONE



### LIVING OUTDOOR



### ARTICOLO / ARTICLE

	Larghezza Width	Profondità Depth	Altezza Height	Colore Color	Codice a barre Barcode
<b>INF050AN/A</b>	1140	142	540		8010693126880
<b>INF050E/A</b>	1140	142	540		8010693126712
<b>INF050MA/A</b>	1140	142	540		8010693126729

### IMBALLO / PACKING

Pz. Pc.	Tipo Type	Larghezza Width	Profondità Depth	Altezza Height
1	cartone/carton box	518	1168	113
1	cartone/carton box	518	1168	113
1	cartone/carton box	518	1168	113

Tutte le misure sono espresse in millimetri / All measures are in millimeters

# > PANNELLO MODULARE

## Modular Fence

Prodotto italiano ecosostenibile  
Eco-sustainable italian product

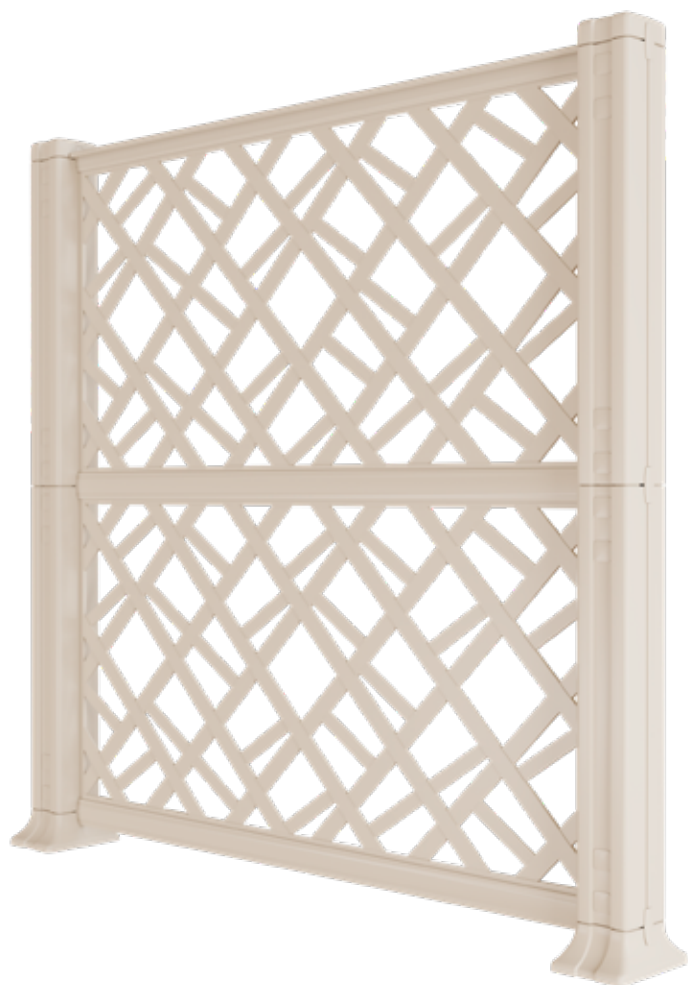

### STARTING KIT SCATOLA 100 A

**INF100E/A**



**Kit composto da:**  
Kit consisting of:

- 2 pannelli decorativi;  
*2 decorative panels;*
- 4 pilastri rinforzati, copri piedi, 2 profili inferiori e 1 superiore;  
*4 reinforced pillars, foot covers, 2 lower and 1 upper profiles;*
- Tappi superiori e laterali;  
*Top and lateral caps;*
- Viteria per assemblaggio e 2 staffe in acciaio per fissaggio a terra;  
*Screws for assembly and 2 steel brackets for fixing to the ground;*
- 2 giunti di rinforzo.  
*2 reinforcement joints.*

#### GARDEN STYLE



#### COMMERCIAL ZONE



#### LIVING OUTDOOR



#### ARTICOLO / ARTICLE

	Larghezza Width	Profondità Depth	Altezza Height	Colore Color	Codice a barre Barcode
<b>INF100AN/A</b>	1140	142	1080		8010693126521
<b>INF100E/A</b>	1140	142	1080		8010693126569
<b>INF100MA/A</b>	1140	142	1080		8010693126484

#### IMBALLO / PACKING

Pz. Pc.	Tipo Type	Larghezza Width	Profondità Depth	Altezza Height
1	cartone/carton box	518	1168	113
1	cartone/carton box	518	1168	113
1	cartone/carton box	518	1168	113

Tutte le misure sono espresse in millimetri / All measures are in millimeters

# > ESTENSIONE LATERALE

## Side Extension

Prodotto italiano ecosostenibile  
Eco-sustainable italian product



prodotto in polipropilene  
produced in polypropylene



non assorbe gli odori  
odor-proof



non trattiene umidità  
doesn't retain humidity



semplice sistema di assemblaggio  
easy assembly system

## SCATOLA 050 C ONLY EXTENSION

**INF050AN/C**



### Kit composto da:

*Kit consisting of:*

- 1 pannello decorativo;  
*1 decorative panel;*
- 1 pilastro rinforzato, copri piede e profilo inferiore e superiore;  
*1 reinforced pillar, foot cover and lower and upper profiles;*
- Tappo superiore;  
*Top cap;*
- Viteria per assemblaggio e 1 staffa in acciaio per fissaggio a terra.  
*Screws for assembly and 1 steel bracket for fixing to the ground.*



**050 A**

**050 C**

**050 A**

**050 C**

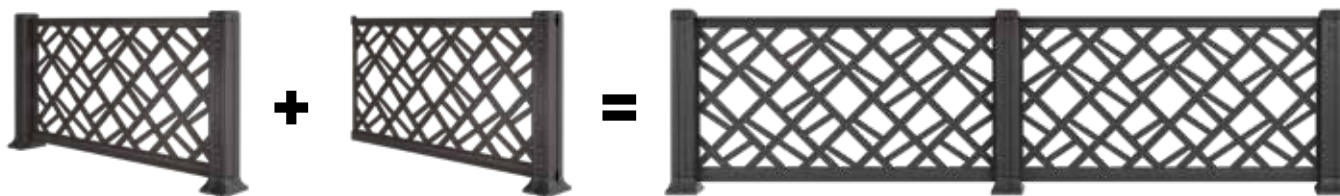

### ARTICOLO / ARTICLE

	Larghezza Width	Profondità Depth	Altezza Height	Colore Color	Codice a barre Barcode
<b>INF050AN/C</b>	1040	142	540		8010693126897
<b>INF050E/C</b>	1040	142	540		8010693126903
<b>INF050MA/C</b>	1040	142	540		8010693126910

### IMBALLO / PACKING

Pz. Pc.	Tipo Type	Larghezza Width	Profondità Depth	Altezza Height
1	cartone/carton box	518	1168	113
1	cartone/carton box	518	1168	113
1	cartone/carton box	518	1168	113

Tutte le misure sono espresse in millimetri / All measures are in millimeters

# > ESTENSIONE LATERALE

Side Extension

Prodotto italiano ecosostenibile  
Eco-sustainable italian product



## SCATOLA 100 C ONLY EXTENSION

INF100E/C



### Kit composto da:

Kit consisting of:

- 2 pannelli decorativi;  
*2 decorative panels;*
- 2 pilastri rinforzati, copri piede, 2 profili inferiori e 1 superiore;  
*2 reinforced pillars, foot cover, 2 lower and 1 upper profiles;*
- Tappo superiore;  
*Top cap;*
- Viteria per assemblaggio e 1 staffa in acciaio per fissaggio a terra;  
*Screws for assembly and 1 steel bracket for fixing to the ground;*
- Giunto di rinforzo.  
*Reinforcement joint.*

100 A

100 C



+



=

100 A

100 C

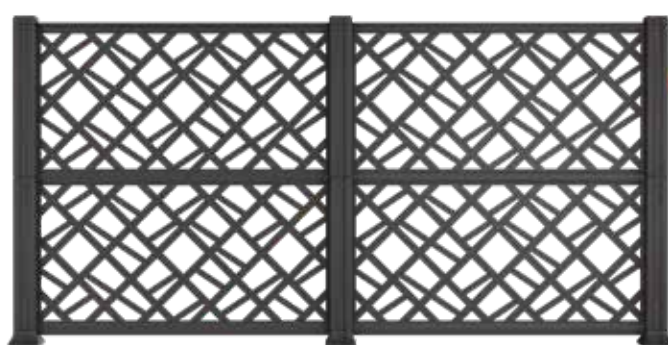

### ARTICOLO / ARTICLE

	Larghezza Width	Profondità Depth	Altezza Height	Colore Color	Codice a barre Barcode
<b>INF100AN/C</b>	1040	142	1080		8010693126545
<b>INF100E/C</b>	1040	142	1080		8010693126583
<b>INF100MA/C</b>	1040	142	1080		8010693126507

### IMBALLO / PACKING

Pz. Pc.	Tipo Type	Larghezza Width	Profondità Depth	Altezza Height
1	cartone/carton box	518	1168	113
1	cartone/carton box	518	1168	113
1	cartone/carton box	518	1168	113

Tutte le misure sono espresse in millimetri / All measures are in millimeters

# > ESTENSIONE VERTICALE

## Vertical Extension

Prodotto italiano ecosostenibile  
Eco-sustainable italian product

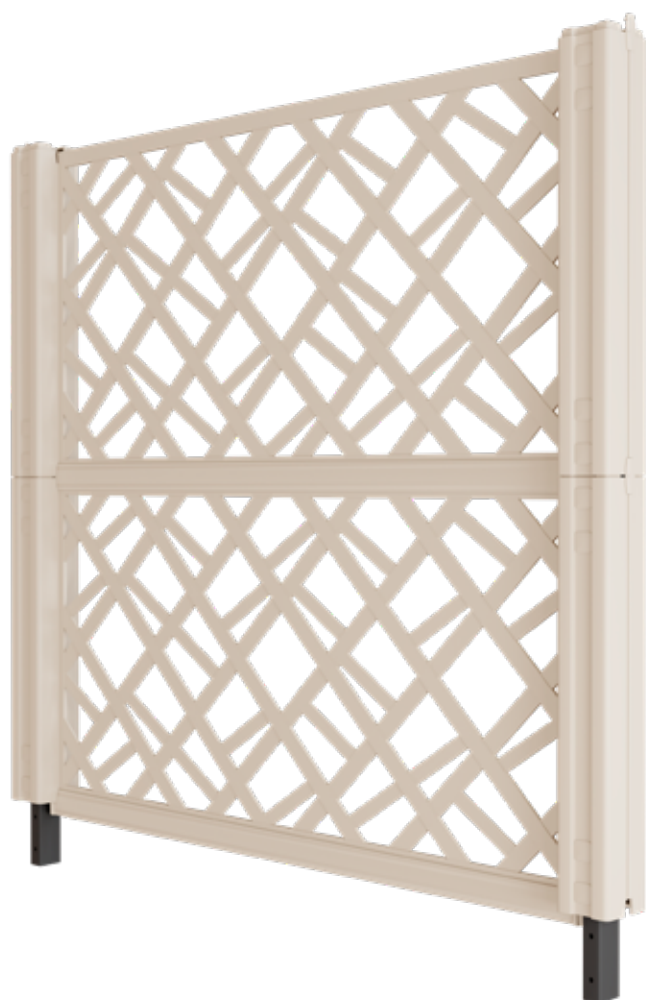

### SCATOLA B ONLY EXTENSION

**INF100E/B**



#### Kit composto da: Kit consisting of:

- 2 pannelli decorativi;  
*2 decorative panels;*
- 2 pilastri rinforzati e 2 profili inferiori;  
*2 reinforced pillars and 2 lower profiles;*
- Tappi laterali;  
*Lateral caps;*
- Viteria per assemblaggio;  
*Screws for assembly;*
- 4 giunti di rinforzo.  
*4 reinforcement joints.*

**100 A**

**B**



+



=

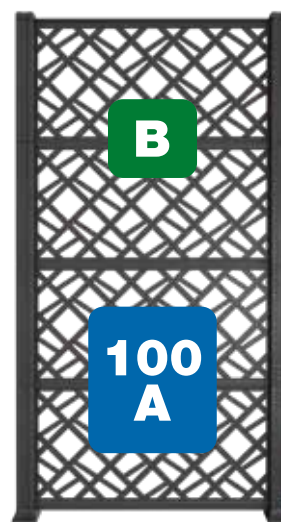

#### ARTICOLO / ARTICLE

	Larghezza Width	Profondità Depth	Altezza Height	Colore Color	Codice a barre Barcode
<b>INF100AN/B</b>	1010	80	1010		8010693126538
<b>INF100E/B</b>	1010	80	1010		8010693126576
<b>INF100MA/B</b>	1010	80	1010		8010693126491

#### IMBALLO / PACKING

Pz. Pc.	Tipo Type	Larghezza Width	Profondità Depth	Altezza Height
1	cartone/carton box	518	1168	113
1	cartone/carton box	518	1168	113
1	cartone/carton box	518	1168	113

Tutte le misure sono espresse in millimetri / All measures are in millimeters

# > ESTENSIONE LATERALE SUPERIORE

Upper Side Extension

Prodotto italiano ecosostenibile  
Eco-sustainable italian product

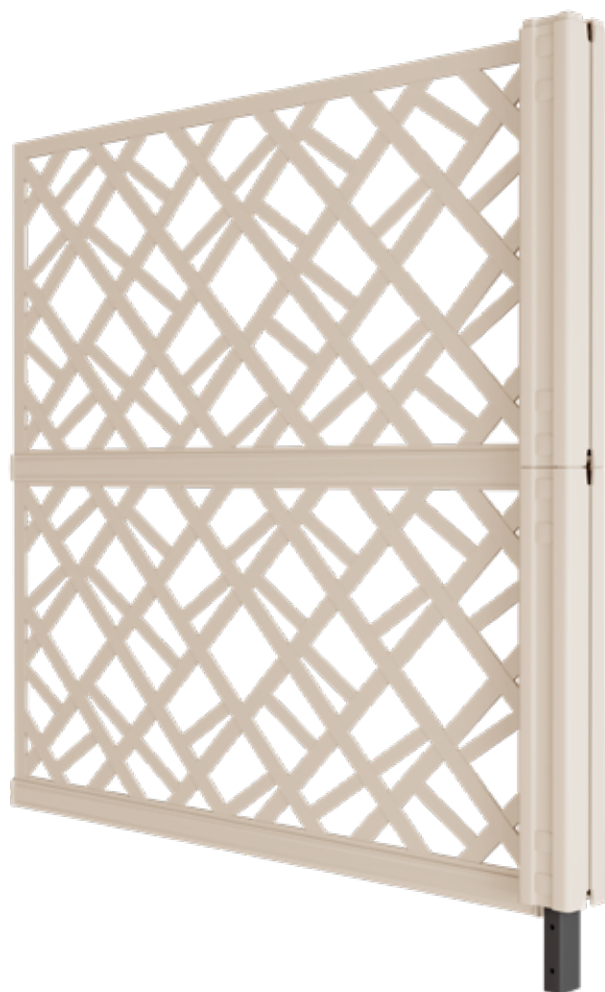

**SCATOLA D  
ONLY EXTENSION**

**INF100E/D**



**Kit composto da:**

*Kit consisting of:*

- 2 pannelli decorativi;  
*2 decorative panels;*
- 2 pilastri rinforzati e 2 profili inferiori;  
*2 reinforced pillars and 2 lower profiles;*
- Viteria per assemblaggio;  
*Screws for assembly;*
- 2 giunti di rinforzo.  
*2 reinforcement joints.*

**100 A**

**B**

**100 C**

**D**

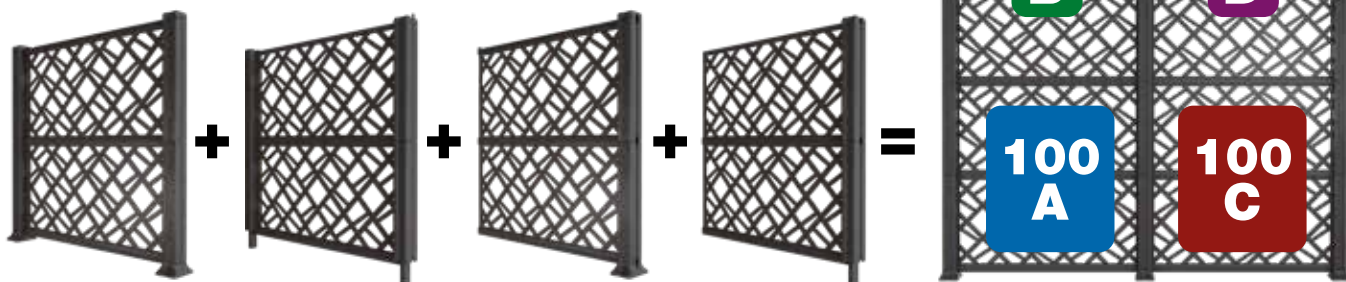

## ARTICOLO / ARTICLE

	Larghezza Width	Profondità Depth	Altezza Height	Colore Color	Codice a barre Barcode
<b>INF100AN/D</b>	1040	80	1010		8010693126552
<b>INF100E/D</b>	1040	80	1010		8010693126590
<b>INF100MA/D</b>	1040	80	1010		8010693126514

## IMBALLO / PACKING

Pz. Pc.	Tipo Type	Larghezza Width	Profondità Depth	Altezza Height
1	cartone/carton box	518	1168	113
1	cartone/carton box	518	1168	113
1	cartone/carton box	518	1168	113

Tutte le misure sono espresse in millimetri / All measures are in millimeters

Linea  
**INFINITY**





# > PANNELLO GRIGLIATO

Grid Panel

Prodotto italiano ecosostenibile  
Eco-sustainable italian product



GARDEN



prodotto in polipropilene  
produced in polypropylene



non assorbe gli odori  
odor-proof



non trattiene umidità  
doesn't retain humidity



semplice sistema di assemblaggio  
easy assembly system



## LA CONFEZIONE COMPRENDE:

Package includes:

**8X**  
Tasselli / plugs



**8X**  
Distanziali / spacer



**8X**  
Viti / screws



**2X PANNELLI** / Panels 1000 x 500 mm

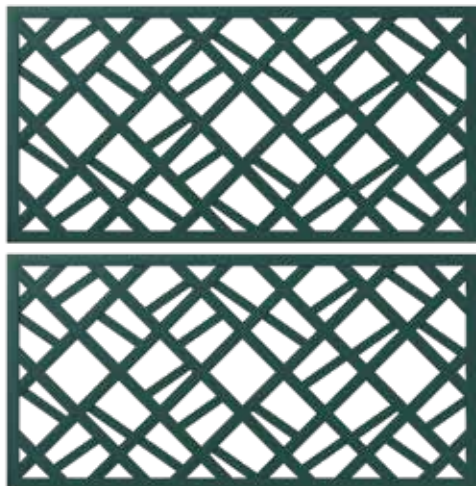

**GR100VS**

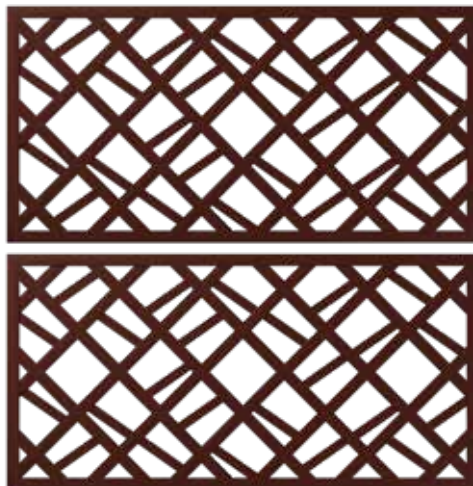

**GR100MS**

## FISSAGGIO A PARETE:

Wall fixing:

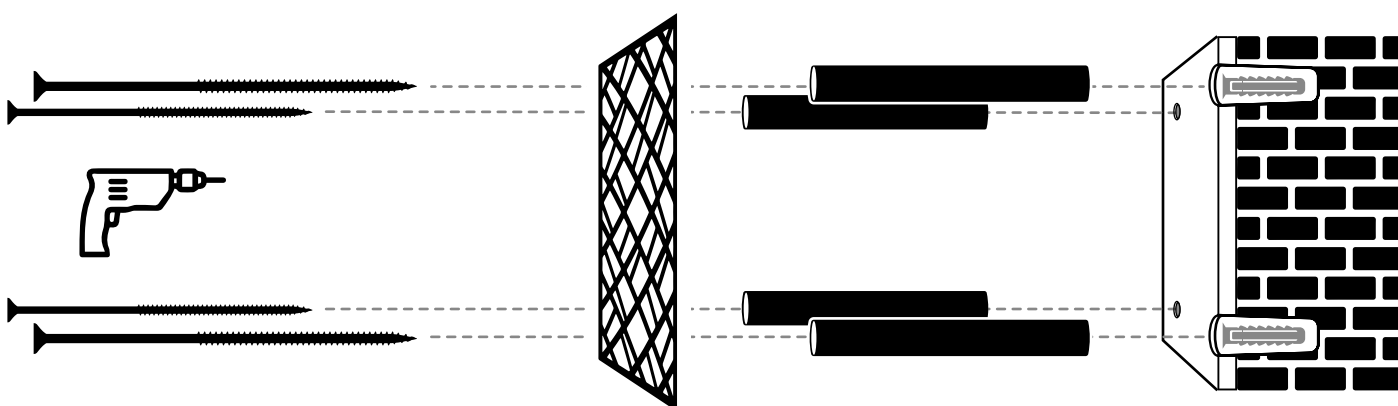

### ARTICOLO / ARTICLE

	Larghezza Width	Profondità Depth	Altezza Height	Codice a barre Barcode
<b>GR100MS</b>	1 pannello/1 panel 992	6	495	8010693125500
<b>GR100VS</b>	1 pannello/1 panel 992	6	495	8010693125975

### IMBALLO / PACKING

Pz. Pc.	Tipo Type	Larghezza Width	Profondità Depth	Altezza Height
1kit	Film termoretrato/Shrunked film	992	35	495
1kit	Film termoretrato/Shrunked film	992	35	495

Tutte le misure sono espresse in millimetri / All measures are in millimeters

Linea  
**GARDEN  
TOOLS**



# > BIOCOMPOSTER

Prodotto italiano ecosostenibile  
Eco-sustainable italian product



prodotto in polipropilene  
produced in polypropylene



non assorbe gli odori  
odor-proof



non trattiene umidità  
doesn't retain humidity



semplice sistema di assemblaggio  
easy assembly system

Feritoie per l'ossigenazione necessaria

*Slits for the oxygenation needed*



Saracinesche apribili  
*Opening doors*



**BC380N**

**BIOCOMPOSTER** è un contenitore adatto ad accogliere i rifiuti organici durante la loro decomposizione aerobica. Ha una capacità di 380 lt. La struttura è composta da pannelli in polipropilene che formano un corpo unico. Ogni parete presenta delle feritoie che garantiscono l'ossigenazione necessaria. Il compost, ovvero il risultato del processo, può essere prelevato direttamente dalla base tramite le saracinesche apribili su tutti e quattro i lati.

**BIOCOMPOSTER** is a container suitable for receiving organic waste during aerobic decomposition. It has a capacity of 380 lt. The structure is composed of polypropylene panels that form a single body. Each wall has slits that provide the necessary oxygenation. The compost, which is the result of the process, may be taken directly from the base via the gate valves that open on all four sides.

## ARTICOLO / ARTICLE

Larghezza Width	Profondità Depth	Altezza Height	Codice a barre Barcode
800	800	820	8010693124114

**BC380N**

## IMBALLO / PACKING

Pz. Pc.	Tipo Type	Larghezza Width	Profondità Depth	Altezza Height
1	cartone/carton	689	135	801

Tutte le misure sono espresse in millimetri / All measures are in millimeters

# Linea **GARDEN TOOLS**

Maniglioni ergonomici  
*Ergonomic handles*

Nervature di rinforzo  
*Reinforcement ribs*

Robuste ruote in PP-Copo.  
*Heavy duty wheels*

Interasse ruote ampio per  
aumentare la stabilità.  
*Wide wheelbase to  
increase the stability*

# > SMART

Prodotto italiano ecosostenibile  
Eco-sustainable italian product



prodotto in polipropilene  
produced in polypropylene



non assorbe gli odori  
odor-proof



non trattiene umidità  
doesn't retain humidity



semplice sistema di assemblaggio  
easy assembly system



**SMART**

## FACILE DA ASSEMBLARE EASY TO ASSEMBLE

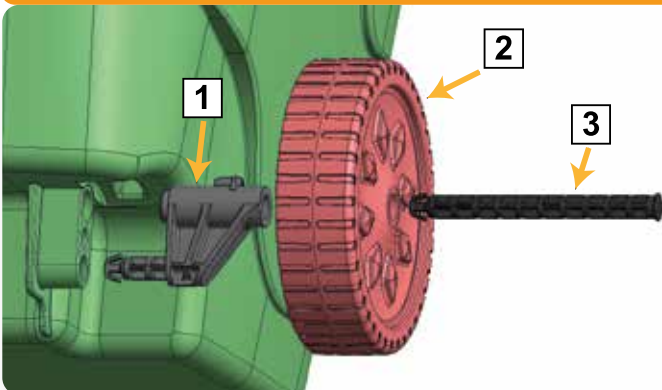

**MONTAGGIO  
BREVETTATO**

### ARTICOLO / ARTICLE

Larghezza Width	Profondità Depth	Altezza Height	Codice a barre Barcode
<b>SMART</b> 485	575	875	8010693125012

### IMBALLO / PACKING

Pz. Pc.	Tipo Type	Larghezza Width	Profondità Depth	Altezza Height
1	sfuso/bulk	485	575	875

Tutte le misure sono espresse in millimetri / All measures are in millimeters

# > SELLETTA

## AVVOLGITUBO UNIVERSALE

Universal tube holder

Prodotto italiano ecosostenibile  
Eco-sustainable italian product



prodotto in polipropilene  
produced in polypropylene



non assorbe gli odori  
not absorb odors



non trattiene umidità  
doesn't retain humidity



Attacchi per muro

Wall attachments

Sostegni di varie dimensioni

Various sizes supports

**STTO**



### ARTICOLO / ARTICLE

Larghezza Width	Profondità Depth	Altezza Height	Codice a barre Barcode
--------------------	---------------------	-------------------	---------------------------

<b>STTO</b> 255	185	165	8010693124046
-----------------	-----	-----	---------------

### IMBALLO / PACKING

Pz. Pc.	Tipo Type	Larghezza Width	Profondità Depth	Altezza Height
------------	--------------	--------------------	---------------------	-------------------

9	cartone/carton	225	259	366
---	----------------	-----	-----	-----

Tutte le misure sono espresse in millimetri / All measures are in millimeters

# > SEGGIOLINO

PANCA PORTA UTENSILI

*Tool holder bench*

Prodotto italiano ecosostenibile  
Eco-sustainable italian product



prodotto in polipropilene  
produced in polypropylene



non assorbe gli odori  
not absorb odors



non trattiene umidità  
doesn't retain humidity

**J58**



Imbottitura in gommapiuma

*Foam rubber padding*

Maniglia di presa

*Carry handle*



Vano porta utensili

*Tool compartment*

## ARTICOLO / ARTICLE

Larghezza Width	Profondità Depth	Altezza Height	Codice a barre Barcode
580	290	370	8010693117826

## IMBALLO / PACKING

Pz. Pc.	Tipo Type	Larghezza Width	Profondità Depth	Altezza Height
4	Sacchetto/plastic bag	290	580	600

Tutte le misure sono espresse in millimetri / All measures are in millimeters

# > GARDEN CLEANER

Prodotto italiano ecosostenibile  
Eco-sustainable italian product



prodotto in  
polipropilene  
produced in  
polypropylene



non assorbe  
gli odori  
not absorb  
odors



non trattiene  
umidità  
doesn't retain  
humidity



**RF45V**



## ARTICOLO / ARTICLE

Larghezza Width	Profondità Depth	Altezza Height	Codice a barre Barcode
450	298	97	8010693123384

**RF45V** kit 2 pz./kit 2 pcs

## IMBALLO / PACKING

Pz. Pc.	Tipo Type	Larghezza Width	Profondità Depth	Altezza Height
7	cartone/carton	470	310	390

Tutte le misure sono espresse in millimetri / All measures are in millimeters



# > ECOPATH

Prodotto italiano ecosostenibile  
Eco-sustainable italian product



GARDEN



prodotto in polipropilene  
produced in polypropylene



non assorbe gli odori  
not absorb odors



non trattiene umidità  
doesn't retain humidity

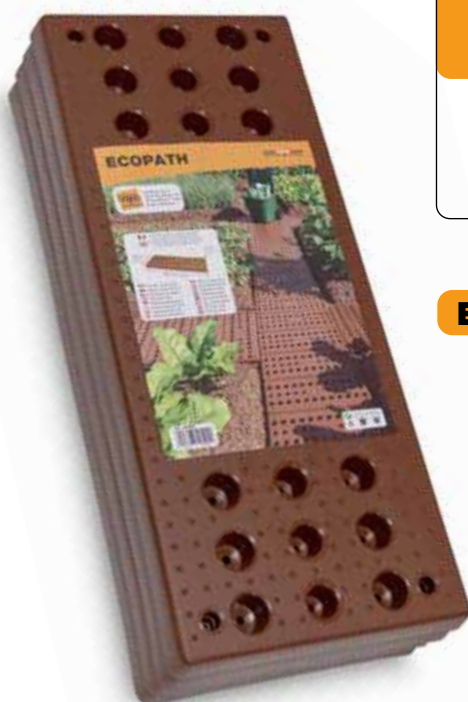

**DISPONIBILE IN KIT CON:**  
*KIT AVAILABLE WITH:*

**4X**



**EPDM**



La struttura forata consente alla Ecopath di far crescere l'erba attraverso i fori.

*The perforated structure of the Ecopath allows grass to grow through the holes.*

## ARTICOLO / ARTICLE

Larghezza Width	Profondità Depth	Altezza Height	Codice a barre Barcode
600	248	29	8010693125029

**EPDM**

1 pezzo/1 piece

## IMBALLO / PACKING

Pz. Pc.	Tipo Type	Larghezza Width	Profondità Depth	Altezza Height
1 kit	Film termoretrato/Shrunked film	600	248	113

Tutte le misure sono espresse in millimetri / All measures are in millimeters

# Linea **PALE DA NEVE**

La linea Pale da Neve comprende vari modelli, robusti e resistenti anche alle bassissime temperature. Questi articoli vengono utilizzati anche in agricoltura e possono essere prodotti con colore a richiesta. Sono stampate con polipropilene particolarmente tenace, ad alta resistenza agli urti e al freddo.

*The Snow Shovels Line includes various models, robust and resistant even at very low temperatures. These items are also used in agriculture and can be produced with other colors on request. The snow shovels are molded in a strong polypropylene with high impact and cold resistance.*



**9500**

Lamina punzonata in metallo  
*Punched foil*



# > Linea **PALE DA NEVE**

Prodotto italiano ecosostenibile  
Eco-sustainable italian product



GARDEN



**9100**



**9200**



**9300**



**9500**



**9200/ECO**

100% Plastica rigenerata  
*100% Regenerated plastic*



prodotto in polipropilene  
produced in polypropylene



non assorbe gli odori  
odor-proof



non trattiene umidità  
doesn't retain humidity



semplice sistema di assemblaggio  
easy assembly system

## ARTICOLO / ARTICLE

	Larghezza Width	Altezza Height	Codice a barre Barcode
<b>9100</b>	335	365	8010693106615
<b>9200</b>	430	350	8010693106592
<b>9300</b>	600	193	8010693106608
<b>9500</b>	430	365	8010693106622
<b>9200/ECO</b>	430	350	8010693124596

## IMBALLO / PACKING

Pz. Pc.	Tipo Type	Larghezza Width	Profondità Depth	Altezza Height
12	cartone/carton	600	341	370
10	cartone/carton	400	395	445
8	cartone/carton	600	199	707
10	cartone/carton	400	395	445
10	cartone/carton	400	395	445

Tutte le misure sono espresse in millimetri / All measures are in millimeters

# > Linea **PALE DA NEVE**

Prodotto italiano ecosostenibile  
Eco-sustainable italian product



## ARTICOLO / ARTICLE

	Larghezza Width	Altezza Height	Codice a barre Barcode
<b>9100M</b>	manico legno/wooden handle 1200 mm 335	365	8010693006601
<b>9200M</b>	manico legno/wooden handle 1200 mm 430	350	8010693018505
<b>9200M.P</b>	manico legno/wooden handle 1200 mm 430	350	8010693018505
<b>9300M</b>	manico legno/wooden handle 1200 mm 600	193	8010693022809
<b>9500M</b>	manico legno/wooden handle 1200 mm 430	365	8010693090006
<b>9200M/ECO</b>	manico legno/wooden handle 1200 mm 439	350	8010693124688

## IMBALLO / PACKING

Pz. Pc.	Tipo Type	Larghezza Width	Profondità Depth	Altezza Height
9	cartone/carton	445	195	1195
10	cartone/carton	445	195	1195
96	cartone/carton	790	1180	890
8	cartone/carton	225	1195	405
10	cartone/carton	445	195	1195
10	cartone/carton	445	195	1195

Tutte le misure sono espresse in millimetri / All measures are in millimeters

# > SNOW

Prodotto italiano ecosostenibile  
Eco-sustainable italian product



prodotto in polipropilene  
produced in polypropylene



non assorbe gli odori  
odor-proof



non trattiene umidità  
doesn't retain humidity



semplice sistema di assemblaggio  
easy assembly system



**SNOW34**



## ARTICOLO / ARTICLE

Larghezza Width	Profondità Depth	Altezza Height	Codice a barre Barcode
<b>SNOW34</b> 525	334	40	8010693124879

## IMBALLO / PACKING

Pz. Pc.	Tipo Type	Larghezza Width	Profondità Depth	Altezza Height
20	cartone/carton	510	510	110

Tutte le misure sono espresse in millimetri / All measures are in millimeters

## Linea **POP-UP**

### **Cilindro**

La nuova linea di piccoli vasi "Pop-up" può essere appesa praticamente ovunque. Il prodotto è composto da un vaso in polipropilene colorato ed un supporto in ferro verniciato che ti permette di appenderlo alla ringhiera, ad una rete ed anche ad un palo con l'utilizzo di una semplice fascetta in plastica.

*The new line of small "Pop-up" vases can be hung almost anywhere. The product consists of a colored polypropylene vase and a painted iron support that allows you to hang it on the railing, on a net and even on a pole with the use of a simple plastic band.*



**POP-UP**  
VASETTO DA APPENDERE

# > Linea POP-UP

Prodotto italiano ecosostenibile  
Eco-sustainable italian product



Per ogni confezione:

For each pack:



**Ø100mm**

	Larghezza Width	Profondità Depth	Altezza Height	Codice a barre Barcode
<b>PPP.010.SB.CO</b>	100	150	130	8010693123766
<b>PPP.010.SB.AN</b>	100	150	130	8010693123261
<b>PPP.010.SB.TO</b>	100	150	130	8010693123278

Lotto 6 vasi in sacchetto

Lot 6 pots in plastic bag

## IMBALLO / PACKING

Pz. Pc.	Tipo Type	Larghezza Width	Profondità Depth	Altezza Height
14	cartone/carton	390	170	500

Per ogni confezione:

For each pack:

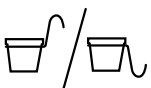

**Ø120mm**

	Larghezza Width	Profondità Depth	Altezza Height	Codice a barre Barcode
<b>PPP.012.SB.CO</b>	120	180	140	8010693123773
<b>PPP.012.SB.AN</b>	120	180	140	8010693123247
<b>PPP.012.SB.TO</b>	120	180	140	8010693123254

Lotto 5 vasi in sacchetto

Lot 5 pots in plastic bag

## IMBALLO / PACKING

Pz. Pc.	Tipo Type	Larghezza Width	Profondità Depth	Altezza Height
10	cartone/carton	390	170	500

Per ogni confezione:

For each pack:

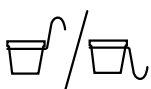

**Ø140mm**

	Larghezza Width	Profondità Depth	Altezza Height	Codice a barre Barcode
<b>PPP.014.SB.CO</b>	140	200	160	8010693123780
<b>PPP.014.SB.AN</b>	140	200	160	8010693123803
<b>PPP.014.SB.TO</b>	140	200	160	8010693123810

Lotto 4 vasi in sacchetto

Lot 4 pots in plastic bag

## IMBALLO / PACKING

Pz. Pc.	Tipo Type	Larghezza Width	Profondità Depth	Altezza Height
9	cartone/carton	390	170	500

Tutte le misure sono espresse in millimetri / All measures are in millimeters

Linea  
**POP-UP**

**Balconetta**

**POP-UP**  
VASETTO DA APPENDERE





# > Linea **POP-UP**

Prodotto italiano ecosostenibile  
Eco-sustainable italian product



GARDEN



**3x**

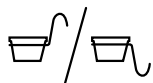

**L220mm**

Lotto 3 vasi in sacchetto  
*Lot 3 pots in plastic bag*

	Larghezza Width	Profondità Depth	Altezza Height	Codice a barre Barcode
<b>PPP.022.CR.CO</b>	220	175	130	8010693123797
<b>PPP.022.CR.AN</b>	220	175	130	8010693123285
<b>PPP.022.CR.TO</b>	220	175	130	8010693123292

## IMBALLO / PACKING

Pz. Pc.	Tipo Type	Larghezza Width	Profondità Depth	Altezza Height
6	cartone/carton	390	170	500



**RISERVA  
D'ACQUA**  
WATER  
RESERVE

Tutte le misure sono espresse in millimetri / All measures are in millimeters

Linea  
**SMILE**



# > Linea **SMILE**

Prodotto italiano ecosostenibile  
Eco-sustainable italian product



GARDEN



## Ø100mm

	Larghezza Width	Profondità Depth	Altezza Height	Codice a barre Barcode
<b>SMI.010.SB.CO</b>	100	100	400	8010693123544
<b>SMI.010.SB.AN</b>	100	100	400	8010693123681
<b>SMI.010.SB.TO</b>	100	100	400	8010693123728

### IMBALLO / PACKING

Pz. Pc.	Tipo Type	Larghezza Width	Profondità Depth	Altezza Height
14	cartone/carton	390	170	500

## Ø120mm

<b>SMI.012.SB.CO</b>	120	120	400	8010693123551
<b>SMI.012.SB.AN</b>	120	120	400	8010693123698
<b>SMI.012.SB.TO</b>	120	120	400	8010693123735

### IMBALLO / PACKING

Pz. Pc.	Tipo Type	Larghezza Width	Profondità Depth	Altezza Height
9	cartone/carton	390	170	500

## Ø140mm

<b>SMI.014.SB.CO</b>	140	140	400	8010693123568
<b>SMI.014.SB.AN</b>	140	140	400	8010693123704
<b>SMI.014.SB.TO</b>	140	140	400	8010693123742

### IMBALLO / PACKING

Pz. Pc.	Tipo Type	Larghezza Width	Profondità Depth	Altezza Height
9	cartone/carton	390	170	500

## Ø160mm

<b>SMI.016.SB.CO</b>	140	140	400	8010693123575
<b>SMI.016.SB.AN</b>	140	140	400	8010693123711
<b>SMI.016.SB.TO</b>	140	140	400	8010693123759

### IMBALLO / PACKING

Pz. Pc.	Tipo Type	Larghezza Width	Profondità Depth	Altezza Height
6	cartone/carton	390	170	500

Tutte le misure sono espresse in millimetri / All measures are in millimeters

NEW! NEW! NEW!  
NEW! NEW! NEW!

Linea  
**BASKET**

**Disponibile anche in queste colorazioni**  
Also available in these colors



# > Linea **BASKET**

Prodotto italiano ecosostenibile  
Eco-sustainable italian product



prodotto in polipropilene  
produced in polypropylene



non assorbe gli odori  
odor-proof



non trattiene umidità  
doesn't retain humidity



semplice sistema di assemblaggio  
easy assembly system



**BAS.016.GA.CO**

**BAS.016.GA.AN**

**BAS.016.GA.TO**

Diametro Ø	Altezza	Colore	Codice a barre
Diameter Ø	Height	Color	Barcode

150	100		8010693125784
-----	-----	--	---------------

150	100		8010693125791
-----	-----	--	---------------

150	100		8010693125807
-----	-----	--	---------------

Diametro Ø	Altezza	Colore	Codice a barre
Diameter Ø	Height	Color	Barcode

**BAS.020.GA.CO**

**BAS.020.GA.AN**

**BAS.020.GA.TO**

200	120		8010693125845
-----	-----	--	---------------

200	120		8010693125852
-----	-----	--	---------------

200	120		8010693125869
-----	-----	--	---------------



**BAS.025.GA.CO**

**BAS.025.GA.AN**

**BAS.025.GA.TO**

Diametro Ø	Altezza	Colore	Codice a barre
Diameter Ø	Height	Color	Barcode

240	150		8010693125876
-----	-----	--	---------------

240	150		8010693125883
-----	-----	--	---------------

240	150		8010693125890
-----	-----	--	---------------



Linea  
**TOTEM**



# > Linea TOTEM

Prodotto italiano ecosostenibile  
Eco-sustainable italian product



prodotto in polipropilene  
produced in polypropylene



non assorbe gli odori  
odor-proof



non trattiene umidità  
doesn't retain humidity



semplice sistema di assemblaggio  
easy assembly system

## Una retina per vaso compresa nella confezione:

*One net for each pot included in the package:*

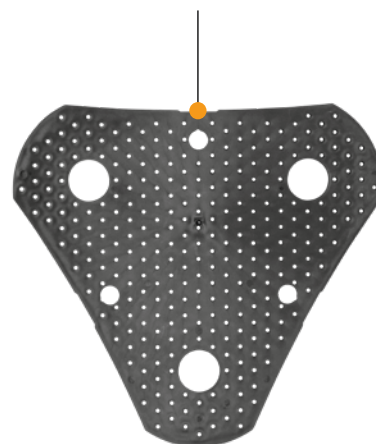

## RISERVA D'ACQUA

*Water reserve*



## POT.120.CR.AN/ESP



## ARTICOLO / ARTICLE

	Larghezza Width	Profondità Depth	Altezza Height	Colore Color	Codice a barre Barcode
<b>POT.120.CR.CO/ESP</b>	410	395	175		8010693125425
<b>POT.120.CR.AN/ESP</b>	410	395	175		8010693125432
<b>POT.120.CR.TO/ESP</b>	410	395	175		8010693125449

## IMBALLO / PACKING

Pz. Pc.	Tipo Type	Larghezza Width	Profondità Depth	Altezza Height
26	cartone/carton box	400	425	1100
26	cartone/carton box	400	425	1100
26	cartone/carton box	400	425	1100

Tutte le misure sono espresse in millimetri / All measures are in millimeters

# > Linea **TOTEM**

Prodotto italiano ecosostenibile  
Eco-sustainable italian product



prodotto in polipropilene  
produced in polypropylene



non assorbe gli odori  
odor-proof



non trattiene umidità  
doesn't retain humidity



semplice sistema di assemblaggio  
easy assembly system



**PERNO RINFORZATO**  
*Reinforced pin*



**Una retina per vaso  
compresa nella confezione:**

*One net for each pot included in  
the package:*

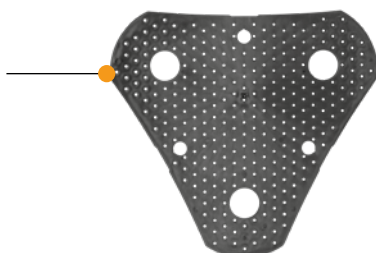

**TRI.120.R3.TO/ESP**



## ARTICOLO / ARTICLE

	Larghezza Width	Profondità Depth	Altezza Height	Colore Color	Codice a barre Barcode
<b>TRI.120.R3.CO/ESP</b>	410	395	550		8010693125364
<b>TRI.120.R3.AN/ESP</b>	410	395	550		8010693125371
<b>TRI.120.R3.TO/ESP</b>	410	395	550		8010693125388

## IMBALLO / PACKING

Pz. Pc.	Tipo Type	Larghezza Width	Profondità Depth	Altezza Height
5	cartone/carton box	400	425	1100
5	cartone/carton box	400	425	1100
5	cartone/carton box	400	425	1100

Tutte le misure sono espresse in millimetri / All measures are in millimeters



# > Linea TOTEM

Prodotto italiano ecosostenibile  
Eco-sustainable italian product



prodotto in polipropilene  
produced in polypropylene



non assorbe gli odori  
odor-proof



non trattiene umidità  
doesn't retain humidity



semplice sistema di assemblaggio  
easy assembly system



**ESTREMITÀ RINFORZATA**  
*Reinforced end*

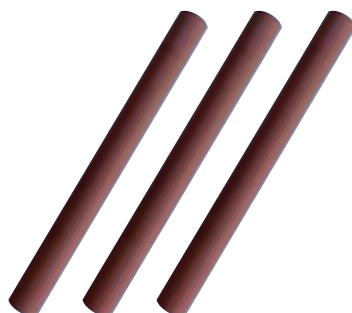

**Una retina per vaso  
compresa nella confezione:**  
*One net for each pot included in  
the package:*

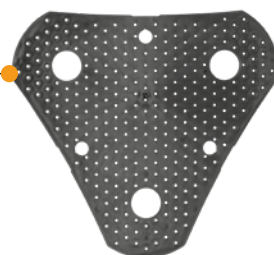

**VEG.120.P2.AN/ESP**



## ARTICOLO / ARTICLE

	Larghezza Width	Profondità Depth	Altezza Height	Colore Color	Codice a barre Barcode
<b>VEG.120.P2.CO/ESP</b>	410	395	650		8010693125395
<b>VEG.120.P2.AN/ESP</b>	410	395	650		8010693125401
<b>VEG.120.P2.TO/ESP</b>	410	395	650		8010693125418

## IMBALLO / PACKING

Pz. Pc.	Tipo Type	Larghezza Width	Profondità Depth	Altezza Height
6	cartone/carton box	400	425	1100
6	cartone/carton box	400	425	1100
6	cartone/carton box	400	425	1100

Tutte le misure sono espresse in millimetri / All measures are in millimeters

# Linea **LOLEGO**

## **Pot**

Con il vaso LoLego puoi divertirti a creare il tuo piccolo angolo verde in casa, sfruttando le opportunità costruttive offerte dalla grande vastità di accessori e combinazioni possibili. Vaso con design morbido, moderno e innovativo che lo rende adattabile ad ambienti sia interni che esterni. Realizzato con riserva d'acqua per garantire un'irrigazione persistente alle piante.

*You can enjoy yourselves, creating your green corner at home, with the pot LoLego, . The pot structure and its accessories allows to get many different combinations. Balcony pot with innovative and modern design, that make it suitable for in and outdoor. Equipped with water reserve, to guarantee durable irrigation to the plants.*



### **Caratteristiche principali** **Main features**

- Prodotto in polipropilene, materiale antiurto  
*Produced in polypropylen, antishock material*
- Impermeabile e resistente a solventi e olii  
*Water proof and resistant against oils and solvents*
- Colore stabile nel tempo  
*Durable color*
- Lavabile, non assorbe odori e non trattiene l'umidità  
*Washable, do not absorb smell and do not keep humidity*
- Stabilità e portata elevate  
*Stability and high loading capacity*
- Semplicissimo da montare  
*Very easy to assemble*
- Adeguato a tutte le normative vigenti  
*In compliance with REACH regulations*



# > Linea **LOLEGO** Pot

Prodotto italiano ecosostenibile  
Eco-sustainable italian product



**L400mm**

## ARTICOLO / ARTICLE

	Larghezza Width	Profondità Depth	Altezza Height	Codice a barre Barcode
<b>POT.040.CR.CO</b>	390	161	160	8010693118526
<b>POT.040.CR.AN</b>	390	161	160	8010693118533
<b>POT.040.CR.TO</b>	390	161	160	8010693118915

## IMBALLO / PACKING

Pz. Pc.	Tipo Type	Larghezza Width	Profondità Depth	Altezza Height
8	cartone/carton	600	400	470

## ARTICOLO / ARTICLE

	Larghezza Width	Profondità Depth	Altezza Height	Codice a barre Barcode
<b>POT.050.CR.CO</b>	490	161	160	8010693116775
<b>POT.050.CR.AN</b>	490	161	160	8010693116799
<b>POT.050.CR.TO</b>	490	161	160	8010693116805



**L500mm**

## IMBALLO / PACKING

Pz. Pc.	Tipo Type	Larghezza Width	Profondità Depth	Altezza Height
8	cartone/carton	390	170	50



**L600mm**

## ARTICOLO / ARTICLE

	Larghezza Width	Profondità Depth	Altezza Height	Codice a barre Barcode
<b>POT.060.CR.CO</b>	590	161	160	8010693118540
<b>POT.060.CR.AN</b>	590	161	160	8010693118557
<b>POT.060.CR.TO</b>	590	161	160	8010693118939

## IMBALLO / PACKING

Pz. Pc.	Tipo Type	Larghezza Width	Profondità Depth	Altezza Height
8	cartone/carton	600	400	470

**RISERVA  
D'ACQUA**  
WATER  
RESERVE



\* Altri colori disponibili con minimi di produzione  
Others colors available on demand with production minimus

# Linea **LOLEGO**

## **Veg Resin**

Vaso con design morbido, moderno e innovativo che lo rende adattabile ad ambienti sia interni che esterni. Realizzato con riserva d'acqua per garantire un'irrigazione persistente alle piante. I supporti si applicano con semplicità, il sistema permette svariate soluzioni di composizioni. Le colonne vengono riposte all'interno dell'ultimo vaso impilato, fornito con etichetta colorata per presentare al meglio il prodotto. Questo sistema permette di risparmiare notevole volume per la movimentazione e l'esposizione risulta ordinata e piacevole.

*Balcony pot with innovative and modern design, that makes it suitable for in and outdoor. Equipped with water reserve, to guarantee durable irrigation to the plants. Thanks to the specific columns, it's very easy to create many compositions.*

*The columns are packed inside of the last stacked pot, supplied with coloured label, to display the product at the best.*

*This system of packaging allows to save a considerable volume for the storage at this product and its exposition on the shelves is tidy and smart.*



## ARTICOLO / ARTICLE

	Larghezza Width	Profondità Depth	Altezza Height	Codice a barre Barcode
<b>VEG.050.R3.AN</b>	490	161	220	8010693115891
<b>VEG.050.R3.CO</b>	490	161	220	8010693117857
<b>VEG.050.R3.TO</b>	490	161	220	8010693115907

## IMBALLO / PACKING

Pz. Pc.	Tipo Type	Larghezza Width	Profondità Depth	Altezza Height
5	cartone/carton	755	220	500
5	cartone/carton	755	220	500
5	cartone/carton	755	220	500



**H995mm**

Assemblato

*Assembled*

Configurazioni personalizzabili con più moduli

*Free to compose your own configuration*



**VEG.050.R3.TO**



**VEG.050.R3.TO/ESP**

## ARTICOLO / ARTICLE

	Larghezza Width	Profondità Depth	Altezza Height	Codice a barre Barcode
<b>VEG.050.R3.AN/ESP</b>	490	161	220	8010693115891
<b>VEG.050.R3.CO/ESP</b>	490	161	220	8010693117857
<b>VEG.050.R3.TO/ESP</b>	490	161	220	8010693115907

## IMBALLO / PACKING

Pz. Pc.	Tipo Type	Larghezza Width	Profondità Depth	Altezza Height
12	cartone/carton	575	380	1040
12	cartone/carton	575	380	1040
12	cartone/carton	575	380	1040

Linea  
**LOLEGO**

**Fly Square**

Balconetta con design morbido, moderno e innovativo che la rende adattabile ad ambienti sia interni che esterni.

Realizzata con riserva d'acqua per garantire un'irrigazione persistente alle piante. Grazie ai supporti specifici è adatta a qualsiasi tipo di balcone. I supporti di metallo hanno diametro 5,5 mm che sono contenuti sul fondo del vaso, sotto alla griglietta per la terra, questo sistema permette di risparmiare notevole volume per la movimentazione e l'esposizione risulta più ordinata e piacevole.

*Balcony pot with innovative and modern design, that makes it suitable for in and outdoor. Equipped with water reserve, to guarantee durable irrigation to the plants. Thanks to the specific supports, it fits on every kind of balcony railing.*

*The metal supports have 5,5 mm diameter, they are packed on the internal bottom of the pot, under the grid for the ground.*

*This system of packaging allows to save a considerable volume for the storage of this product and its exposition on the shelves is tidy and smart.*



# > Linea **LOLEGO** Fly Square

Prodotto italiano ecosostenibile  
Eco-sustainable italian product



## VASO APPESO CON AGGANCI SQUADRATO

*Pot with metal squared bracket*

	Larghezza Width	Profondità Depth	Altezza Height	Codice a barre Barcode
<b>FLY.040.SQ.CO</b>	390	161	160	8010693118823
<b>FLY.040.SQ.AN</b>	390	161	160	8010693118847
<b>FLY.040.SQ.TO</b>	390	161	160	8010693118854



**L400mm**

### IMBALLO / PACKING

Pz. Pc.	Tipo Type	Larghezza Width	Profondità Depth	Altezza Height
8	cartone/carton	600	400	470



**L500mm**

	Larghezza Width	Profondità Depth	Altezza Height	Codice a barre Barcode
<b>FLY.050.SQ.CO</b>	490	161	160	8010693116737
<b>FLY.050.SQ.AN</b>	490	161	160	8010693116751
<b>FLY.050.SQ.TO</b>	490	161	160	8010693116768

### IMBALLO / PACKING

Pz. Pc.	Tipo Type	Larghezza Width	Profondità Depth	Altezza Height
8	cartone/carton	390	170	500



**L600mm**

	Larghezza Width	Profondità Depth	Altezza Height	Codice a barre Barcode
<b>FLY.060.SQ.CO</b>	590	161	160	8010693118861
<b>FLY.060.SQ.AN</b>	590	161	160	8010693118885
<b>FLY.060.SQ.TO</b>	590	161	160	8010693118892

### IMBALLO / PACKING

Pz. Pc.	Tipo Type	Larghezza Width	Profondità Depth	Altezza Height
8	cartone/carton	600	400	470



	Larghezza Width	Profondità Depth	Altezza Height	Codice a barre Barcode
<b>FLY.050.SQ.CO/ESP</b>	500	161	160	801069311673
<b>FLY.050.SQ.AN/ESP</b>	500	161	160	8010693116751
<b>FLY.050.SQ.TO/ESP</b>	500	161	160	8010693116768

### IMBALLO / PACKING

Pz. Pc.	Tipo Type	Larghezza Width	Profondità Depth	Altezza Height
58	cartone/carton	575	380	1040



i ganci smontati, sono  
riposti all'interno del vaso  
the disassembled hooks  
are placed inside the pot

\* Altri colori disponibili con minimi  
di produzione  
*Others colors available on demand with  
production minimus*

Linea  
**LOLEGO**

**Fly Curved**

Balconetta con design morbido, moderno e innovativo che la rende adattabile ad ambienti sia interni che esterni.

Realizzata con riserva d'acqua per garantire un'irrigazione persistente alle piante. Grazie ai supporti specifici è adatta a qualsiasi tipo di balcone. I supporti di metallo hanno diametro

5,5 mm che sono contenuti sul fondo del vaso, sotto alla griglietta per la terra, questo sistema permette di risparmiare notevole volume per la movimentazione e l'esposizione risulta più ordinata e piacevole.

*Balcony pot with innovative and modern design, that makes it suitable for in and outdoor. Equipped with water reserve, to guarantee durable irrigation to the plants. Thanks to the specific supports, it fits on every kind of balcony railing.*

*The metal supports have 5,5 mm diameter, they are packed on the internal bottom of the pot, under the grid for the ground.*

*This system of packaging allows to save a considerable volume for the storage of this product and its exposition on the shelves is tidy and smart.*





# > Linea **LOLEGO** Fly Curved

Prodotto italiano ecosostenibile  
Eco-sustainable italian product



## VASO APPESO CON AGGANCI CURVO

*Pot with metal curved bracket*

	Larghezza Width	Profondità Depth	Altezza Height	Codice a barre Barcode
<b>FLY.040.CU.CO</b>	390	161	160	8010693118748
<b>FLY.040.CU.AN</b>	390	161	160	8010693118762
<b>FLY.040.CU.TO</b>	390	161	160	8010693118779



**L400mm**

### IMBALLO / PACKING

Pz. Pc.	Tipo Type	Larghezza Width	Profondità Depth	Altezza Height
8	cartone/carton	600	400	470



**L500mm**

Larghezza Width	Profondità Depth	Altezza Height	Codice a barre Barcode
--------------------	---------------------	-------------------	---------------------------

<b>FLY.050.CU.CO</b>	490	161	160	8010693116003
<b>FLY.050.CU.AN</b>	490	161	160	8010693115990
<b>FLY.050.CU.TO</b>	490	161	160	8010693116461

### IMBALLO / PACKING

Pz. Pc.	Tipo Type	Larghezza Width	Profondità Depth	Altezza Height
8	cartone/carton	390	170	500

Larghezza Width	Profondità Depth	Altezza Height	Codice a barre Barcode
--------------------	---------------------	-------------------	---------------------------

<b>FLY.060.CU.CO</b>	590	161	160	8010693118786
<b>FLY.060.CU.AN</b>	590	161	160	8010693118809
<b>FLY.060.CU.TO</b>	590	161	160	8010693118816

### IMBALLO / PACKING

Pz. Pc.	Tipo Type	Larghezza Width	Profondità Depth	Altezza Height
8	cartone/carton	600	400	470



**L600mm**



Larghezza Width	Profondità Depth	Altezza Height	Codice a barre Barcode
--------------------	---------------------	-------------------	---------------------------

<b>FLY.050.CU.CO/ESP</b>	500	161	160	8010693116003
<b>FLY.050.CU.AN/ESP</b>	500	161	160	8010693115990
<b>FLY.050.CU.TO/ESP</b>	500	161	160	8010693116461

### IMBALLO / PACKING

Pz. Pc.	Tipo Type	Larghezza Width	Profondità Depth	Altezza Height
58	cartone/carton	575	380	1040



i ganci smontati, sono  
riposti all'interno del vaso  
the disassembled hooks  
are placed inside the pot

\* Altri colori disponibili con minimi  
di produzione  
*Others colors available on demand with  
production minimus*

Linea  
**LOLEGO**

**Fly Ring**

Balconetta con design morbido, moderno e innovativo che la rende adattabile ad ambienti sia interni che esterni.

Realizzata con riserva d'acqua per garantire un'irrigazione persistente alle piante. Grazie ai supporti specifici è adatta a qualsiasi tipo di balcone. I supporti di metallo hanno diametro

5,5 mm che sono contenuti sul fondo del vaso, sotto alla griglietta per la terra, questo sistema permette di risparmiare notevole volume per la movimentazione e l'esposizione risulta più ordinata e piacevole.

*Balcony pot with innovative and modern design, that makes it suitable for in and outdoor. Equipped with water reserve, to guarantee durable irrigation to the plants. Thanks to the specific supports, it fits on every kind of balcony railing.*

*The metal supports have 5,5 mm diameter, they are packed on the internal bottom of the pot, under the grid for the ground.*

*This system of packaging allows to save a considerable volume for the storage of this product and its exposition on the shelves is tidy and smart.*



# > Linea **LOLEGO** Fly Ring

Prodotto italiano ecosostenibile  
Eco-sustainable italian product



## VASO APPESO CON AGGANCIAMO CURVO

*Pot with metal curved bracket*



**L400mm**

	Larghezza Width	Profondità Depth	Altezza Height	Codice a barre Barcode
<b>FLY.040.RI.CO</b>	395	290	180	8010693121564
<b>FLY.040.RI.AN</b>	395	290	180	8010693121588
<b>FLY.040.RI.TO</b>	395	290	180	8010693121595



La struttura in ferro è impilabile e tenuta in posizione eretta

*The iron structure is stackable and held erected in place*



	Larghezza Width	Profondità Depth	Altezza Height	Codice a barre Barcode
<b>FLY.050.RI.CO</b>	495	290	185	8010693121601
<b>FLY.050.RI.AN</b>	495	290	185	8010693121625
<b>FLY.050.RI.TO</b>	495	290	185	8010693121632



**L600mm**



**L500mm**

Tasto di sicurezza, serve a tenere la fioriera unita al vaso e mantiene in ordine la sovrapposizione per esporli ben allineati

*Safety button, serves to hold the planter together with the vase and keeps the overlap in order to expose them well aligned*

	Larghezza Width	Profondità Depth	Altezza Height	Codice a barre Barcode
<b>FLY.060.RI.CO</b>	595	290	190	8010693121649
<b>FLY.060.RI.AN</b>	595	290	190	8010693121663
<b>FLY.060.RI.TO</b>	595	290	190	8010693121670

\* Altri colori disponibili con minimi di produzione  
*Others colors available on demand with production minimus*

NEW! NEW! NEW! NEW! NEW!

Linea  
**LOLEGO**

**Fly Safe**

Balconetta con design morbido, moderno e innovativo che la rende adattabile ad ambienti sia interni che esterni.

Realizzata con riserva d'acqua per garantire un'irrigazione persistente alle piante. Grazie ai supporti specifici è adatta a qualsiasi tipo di balcone. I supporti di metallo hanno diametro 5,5 mm che sono contenuti sul fondo del vaso, sotto alla griglietta per la terra, questo sistema permette di risparmiare notevole volume per la movimentazione e l'esposizione risulta più ordinata e piacevole.

*Balcony pot with innovative and modern design, that makes it suitable for in and outdoor. Equipped with water reserve, to guarantee durable irrigation to the plants. Thanks to the specific supports, it fits on every kind of balcony railing.*

*The metal supports have 5,5 mm diameter, they are packed on the internal bottom of the pot, under the grid for the ground.*

*This system of packaging allows to save a considerable volume for the storage of this product and its exposition on the shelves is tidy and smart.*



# > Linea **LOLEGO** Fly Safe

Prodotto italiano ecosostenibile  
Eco-sustainable italian product



## VASO APPESO CON AGGANCIO CURVO

*Pot with metal curved bracket*

### ARTICOLO / ARTICLE

	Larghezza Width	Profondità Depth	Altezza Height
<b>FLY.040.SA.CO</b>	390	161	160
<b>FLY.040.SA.AN</b>	390	161	160
<b>FLY.040.SA.TO</b>	390	161	160



SISTEMA ANTICADUTA  
*Anti-Fall System*

**L400mm**



SISTEMA ANTICADUTA  
*Anti-Fall System*

**L500mm**

### ARTICOLO / ARTICLE

	Larghezza Width	Profondità Depth	Altezza Height
<b>FLY.050.SA.CO</b>	490	161	160
<b>FLY.050.SA.AN</b>	490	161	160
<b>FLY.050.SA.TO</b>	490	161	160



SISTEMA ANTICADUTA  
*Anti-Fall System*

**L600mm**

### ARTICOLO / ARTICLE

	Larghezza Width	Profondità Depth	Altezza Height
<b>FLY.060.SA.CO</b>	590	161	160
<b>FLY.060.SA.AN</b>	590	161	160
<b>FLY.060.SA.TO</b>	590	161	160

\* Altri colori disponibili con minimi di produzione  
*Others colors available on demand with production minimus*

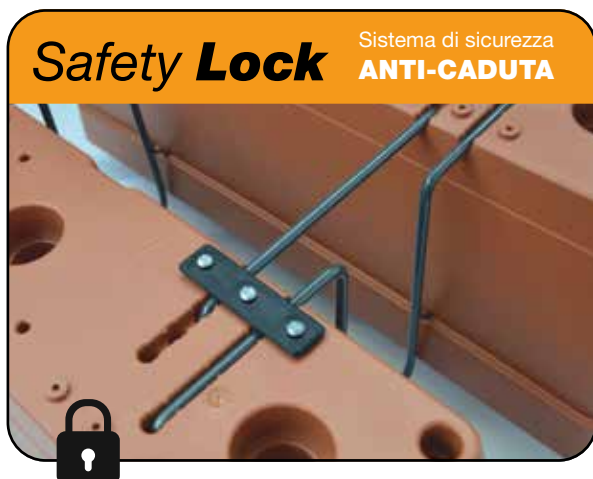

**Safety Lock** Sistema di sicurezza  
**ANTI-CADUTA**

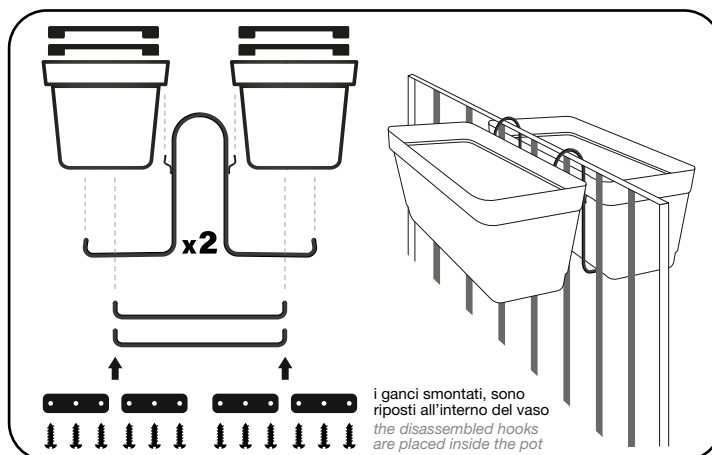

Tutte le misure sono espresse in millimetri / All measures are in millimeters

Linea  
**CILINDRO**



# > CILINDRO

Prodotto italiano ecosostenibile  
Eco-sustainable italian product



**Ø160mm**

	Larghezza Width	Altezza Height	Codice a barre Barcode
<b>CIL.016.CB.CO</b>	160	115	8010693100620
<b>CIL.016.CB.AN</b>	160	115	8010693105601
<b>CIL.016.CB.TO</b>	160	115	8010693105656

	Larghezza Width	Altezza Height	Codice a barre Barcode
<b>CIL.018.CB.CO</b>	180	125	8010693100644
<b>CIL.018.CB.AN</b>	180	125	8010693105557
<b>CIL.018.CB.TO</b>	180	125	8010693108190



**Ø180mm**



**Ø200mm**

	Larghezza Width	Altezza Height	Codice a barre Barcode
<b>CIL.020.CB.CO</b>	200	140	8010693100668
<b>CIL.020.CB.AN</b>	200	140	8010693106646
<b>CIL.020.CB.TO</b>	200	140	8010693106660

	Larghezza Width	Altezza Height	Codice a barre Barcode
<b>CIL.022.CB.CO</b>	220	165	8010693100682
<b>CIL.022.CB.AN</b>	220	165	8010693107063
<b>CIL.022.CB.TO</b>	220	165	8010693107087



**Ø220mm**



**Ø250mm**

	Larghezza Width	Altezza Height	Codice a barre Barcode
<b>CIL.025.CB.CO</b>	250	200	8010693100705
<b>CIL.025.CB.AN</b>	250	200	8010693106684
<b>CIL.025.CB.TO</b>	250	200	8010693106707

	Larghezza Width	Altezza Height	Codice a barre Barcode
<b>CIL.030.CB.CO</b>	300	230	8010693100729
<b>CIL.030.CB.AN</b>	300	230	8010693106738
<b>CIL.030.CB.TO</b>	300	230	8010693106745



**Ø300mm**

**Sottovasi a pag. 381**  
**Saucers on page 381**



**Ø350mm**

	Larghezza <i>Width</i>	Altezza <i>Height</i>	Codice a barre <i>Barcode</i>
<b>CIL.035.CB.CO</b>	350	260	8010693100781
<b>CIL.035.CB.AN</b>	350	260	8010693101610
<b>CIL.035.CB.TO</b>	350	260	8010693106929



**Ø400mm**

	Larghezza <i>Width</i>	Altezza <i>Height</i>	Codice a barre <i>Barcode</i>
<b>CIL.040.CB.CO</b>	400	300	8010693100859
<b>CIL.040.CB.AN</b>	400	300	8010693106936
<b>CIL.040.CB.TO</b>	400	300	8010693106943



**Ø450mm**

	Larghezza <i>Width</i>	Altezza <i>Height</i>	Codice a barre <i>Barcode</i>
<b>CIL.045.CB.CO</b>	450	350	8010693100866
<b>CIL.045.CB.AN</b>	450	350	8010693101474
<b>CIL.045.CB.TO</b>	450	350	8010693107643



# > CILINDRO

Prodotto italiano ecosostenibile  
Eco-sustainable italian product



GARDEN



**Ø500mm**

	Larghezza Width	Altezza Height	Codice a barre Barcode
<b>CIL.050.CB.CO</b>	500	400	8010693100873
<b>CIL.050.CB.AN</b>	500	400	8010693107681
<b>CIL.050.CB.TO</b>	500	400	8010693107704



**Ø600mm**

	Larghezza Width	Altezza Height	Codice a barre Barcode
<b>CIL.060.CB.CO</b>	600	450	8010693100880
<b>CIL.060.CB.AN</b>	600	450	8010693101603
<b>CIL.060.CB.TO</b>	600	450	8010693109074

**Sottovasi a pag. 381**  
*Saucers on page 381*

Tutte le misure sono espresse in millimetri / All measures are in millimeters

Linea  
**CILINDRO**



# > CILINDRO SUPPORTO

Prodotto italiano ecosostenibile  
Eco-sustainable italian product



SUPPORTO VASO CILINDRO

*Cylinder pot support*



**Ø220mm**

	Larghezza Width	Profondità Depth	Altezza Height	Codice a barre Barcode
<b>SUP.022.CI</b>	220	290	250	8010693121830
<b>SUP.025.CI</b>	250	315	250	8010693118014



**Ø250mm**

Linea  
**CAMPANA**



# > CAMPANA



Prodotto italiano ecosostenibile  
Eco-sustainable italian product



GARDEN





**Ø200mm**

	Larghezza Width	Altezza Height	Codice a barre Barcode
<b>CAM.020.CB.CO</b> 	200	160	8010693100798
<b>CAM.020.CB.AN</b> 	200	160	8010693103850
<b>CAM.020.CB.TO</b> 	200	160	8010693107476









**Ø250mm**

	Larghezza Width	Altezza Height	Codice a barre Barcode
<b>CAM.025.CB.CO</b> 	250	200	8010693100804
<b>CAM.025.CB.AN</b> 	250	200	8010693101627
<b>CAM.025.CB.TO</b> 	250	200	8010693106547



**Ø300mm**

	Larghezza Width	Altezza Height	Codice a barre Barcode
<b>CAM.030.CB.CO</b> 	300	240	8010693100811
<b>CAM.030.CB.AN</b> 	300	240	8010693103867
<b>CAM.030.CB.TO</b> 	300	240	8010693107490



	Larghezza Width	Altezza Height	Codice a barre Barcode
<b>CAM.035.CB.CO</b> 	350	280	8010693100828
<b>CAM.035.CB.AN</b> 	350	280	8010693101634
<b>CAM.035.CB.TO</b> 	350	280	8010693107513



**Ø350mm**



**Ø400mm**

	Larghezza Width	Altezza Height	Codice a barre Barcode
<b>CAM.040.CB.CO</b> 	400	320	8010693100897
<b>CAM.040.CB.AN</b> 	400	320	8010693101641
<b>CAM.040.CB.TO</b> 	400	320	8010693107544

**Sottovasi a pag. 381**  
**Saucers on page 381**

Linea  
**QUADRO  
MAXI**



# > QUADRO MAXI



Prodotto italiano ecosostenibile  
Eco-sustainable italian product



GARDEN





**L320mm**

	Profondità Depth	Altezza Height	Codice a barre Barcode
<b>MAX.032.CB.CO</b> 	320	285	8010693100521
<b>MAX.032.CB.AN</b> 	320	285	8010693110001
<b>MAX.032.CB.TO</b> 	320	285	8010693109999



**L380mm**

	Profondità Depth	Altezza Height	Codice a barre Barcode
<b>MAX.038.CB.CO</b> 	380	380	8010693100538
<b>MAX.038.CB.AN</b> 	380	380	8010693110049
<b>MAX.038.CB.TO</b> 	380	380	8010693110032

**Sottovasi a pag. 381**  
*Saucers on page 381*

Tutte le misure sono espresse in millimetri / All measures are in millimeters

Linea  
**CASSETTA  
MAXI**





# > CASSETTA MAXI

Prodotto italiano ecosostenibile  
Eco-sustainable italian product



GARDEN



	Profondità Depth	Altezza Height	Codice a barre Barcode
<b>MAX.060.CB.CO</b>	320	285	8010693100453
<b>MAX.060.CB.AN</b>	320	285	8010693101450
<b>MAX.060.CB.TO</b>	320	285	8010693107346

**L600mm**



	Profondità Depth	Altezza Height	Codice a barre Barcode
<b>MAX.080.CB.CO</b>	380	380	8010693100460
<b>MAX.080.CB.AN</b>	380	380	8010693101306
<b>MAX.080.CB.TO</b>	380	380	8010693107575

**L800mm**



**L1000mm**

	Profondità Depth	Altezza Height	Codice a barre Barcode
<b>MAX.100.CB.CO</b>	420	435	8010693100484
<b>MAX.100.CB.AN</b>	420	435	8010693101313
<b>MAX.100.CB.TO</b>	420	435	8010693107452

**Sottovasi a pag. 381**  
*Saucers on page 381*



Linea  
**OLIMPO**



VASO A MURO  
*Wall pot*



**Ø300mm**

	Larghezza Width	Profondità Depth	Altezza Height	Codice a barre Barcode
<b>ICA.030.CB.CO</b>	300 	190	220	8010693100835
<b>ICA.030.CB.AN</b>	300 	190	220	8010693107568



**Ø300mm**



Linea  
**OLIMPO**



VASO CON SUPPORTO  
*Pot with support*



**Ø300mm**

	Larghezza Width	Profondità Depth	Altezza Height	Codice a barre Barcode
<b>ZEU.030.CS.CO</b>	300 	300	290	8010693100842
<b>ZEU.030.CS.AN</b>	300 	300	290	8010693101597

Linea  
**CIOTOLA**



# > CIOTOLA LEADER

Prodotto italiano ecosostenibile  
Eco-sustainable italian product



GARDEN



	Ø200mm		Codice a barre Barcode
	Larghezza Width	Altezza Height	
<b>LDR.020.CS.CO</b>	200	105	8010693115631
<b>LDR.020.CS.AN</b>	200	105	8010693115655
<b>LDR.020.CS.TO</b>	200	105	8010693115679

	Lunghezza Length	Codice a barre Barcode	
<b>GAN.038.MO.CO</b>	380	8010693108015	
<b>GAN.038.MO.AN</b>	380	8010693114429	
<b>GAN.038.MO.TO</b>	380	8010693116492	



	Ø250mm		Codice a barre Barcode
	Larghezza Width	Altezza Height	
<b>LDR.025.CS.CO</b>	250	120	8010693115709
<b>LDR.025.CS.AN</b>	250	120	8010693115723
<b>LDR.025.CS.TO</b>	250	120	8010693115747

	Lunghezza Length	Codice a barre Barcode	
<b>GAN.046.MO.CO</b>	460	8010693108022	
<b>GAN.046.MO.AN</b>	460	8010693112272	
<b>GAN.046.MO.TO</b>	460	8010693112265	



	Ø300mm		Codice a barre Barcode
	Larghezza Width	Altezza Height	
<b>LDR.030.CS.CO</b>	300	135	8010693115778
<b>LDR.030.CS.AN</b>	300	135	8010693115792
<b>LDR.030.CS.TO</b>	300	135	8010693115815

	Lunghezza Length	Codice a barre Barcode	
<b>GAN.054.MO.CO</b>	540	8010693114559	
<b>GAN.054.MO.AN</b>	540	8010693116515	
<b>GAN.054.MO.TO</b>	540	8010693116508	

Tutte le misure sono espresse in millimetri / All measures are in millimeters

Linea  
**CIOTOLA**





# > CIOTOLA SALLY

Prodotto italiano ecosostenibile  
Eco-sustainable italian product



GARDEN



## L250mm

	Larghezza Width	Altezza Height	Codice a barre Barcode
<b>SAL.024.CS.CO</b>	240	125	8010693103201
<b>SAL.024.CS.AN</b>	240	125	8010693104574
<b>SAL.024.CS.TO</b>	240	125	8010693109159



## L300mm

	Larghezza Width	Altezza Height	Codice a barre Barcode
<b>SAL.030.CS.CO</b>	300	155	8010693103218
<b>SAL.030.CS.AN</b>	300	155	8010693109180
<b>SAL.030.CS.TO</b>	300	155	8010693109173

**VASO  
ORCHIDEA**



# > VASO ORCHIDEA

Prodotto italiano ecosostenibile  
Eco-sustainable italian product



GARDEN



**Ø180mm**

	Larghezza Width	Altezza Height	Codice a barre Barcode
<b>DEA.018.SB.TR</b>	184	145	8010693116812

Tutte le misure sono espresse in millimetri / All measures are in millimeters

# SOTTOVASI



# > SOTTOVASI

Prodotto italiano ecosostenibile  
Eco-sustainable italian product



**N.B. Sottovasi per vasi CAMPANA:**  
Ø sottovaso = Ø Campana - 2 taglie  
Es. vaso Campana Ø 35mm = sottovaso Ø 26mm

	Ø		Ø		Ø		Ø
SOT.014.SV.CO	140	SOT.020.SV.CO	200	SOT.026.SV.CO	260	SOT.040.SV.CO	400
SOT.014.SV.AN	140	SOT.020.SV.AN	200	SOT.026.SV.AN	260	SOT.040.SV.AN	400
SOT.014.SV.TO	140	SOT.020.SV.TO	200	SOT.026.SV.TO	260	SOT.040.SV.TO	400
SOT.016.SV.CO	160	SOT.022.SV.CO	220	SOT.030.SV.CO	300	SOT.045.SV.CO	450
SOT.016.SV.AN	160	SOT.022.SV.AN	220	SOT.030.SV.AN	300	SOT.045.SV.AN	450
SOT.016.SV.TO	160	SOT.022.SV.TO	220	SOT.030.SV.TO	300	SOT.045.SV.TO	450
SOT.018.SV.CO	180	SOT.025.SV.CO	250	SOT.035.SV.CO	350	SOT.050.SV.CO	500
SOT.018.SV.AN	180	SOT.025.SV.AN	250	SOT.035.SV.AN	350	SOT.050.SV.AN	500
SOT.018.SV.TO	180	SOT.025.SV.TO	250	SOT.035.SV.TO	350	SOT.050.SV.TO	500

## COLORI DISPONIBILI AVAILABLE COLORS



MAX.032.SV.CO  
MAX.032.SV.AN  
MAX.032.SV.TO

	Larg. Width	Prof. Depth		Larg. Width	Prof. Depth
MAX.038.SV.CO	320	320	MAX.038.SV.CO	380	380
MAX.038.SV.AN	320	320	MAX.038.SV.AN	380	380
MAX.038.SV.TO	320	320	MAX.038.SV.TO	380	380



	Larg. Width	Prof. Depth		Larg. Width	Prof. Depth		Larg. Width	Prof. Depth
MAX.060.SV.CO	600	300	MAX.080.SV.CO	800	360	MAX.100.SV.CO	1000	400
MAX.060.SV.AN	600	300	MAX.080.SV.AN	800	360	MAX.100.SV.AN	1000	400
MAX.060.SV.TO	600	300	MAX.080.SV.TO	800	360	MAX.100.SV.TO	1000	400

Tutte le misure sono espresse in millimetri / All measures are in millimeters

**SOTTOVASO  
LAMPO**



# > SOTTOVASO LAMPO

Prodotto italiano ecosostenibile  
Eco-sustainable italian product



GARDEN



**Ø280mm**

	Larghezza Width	Altezza Height	Codice a barre Barcode
<b>LAM.028.SV.CO</b>	280	130	8010693102235
<b>LAM.028.SV.AN</b>	280	130	8010693110421
<b>LAM.028.SV.TO</b>	280	130	8010693110414



**Ø330mm**

	Larghezza Width	Altezza Height	Codice a barre Barcode
<b>LAM.033.SV.CO</b>	330	130	8010693102242
<b>LAM.033.SV.AN</b>	330	130	8010693110483
<b>LAM.033.SV.TO</b>	330	130	8010693110476

## > PLASTICA RIGENERATA

Nella storia dello sviluppo della nostra azienda abbiamo sempre avuto un occhio di riguardo nei confronti delle innovazioni tecnologiche che mirassero a ridurre sempre di più l'impatto ambientale della produzione industriale. Passo dopo passo abbiamo raggiunto tappe sempre più importanti ed ambiziose, fino al risultato che abbiamo sempre sognato: realizzare prodotti composti al 100% da materiale rigenerato.

*In the history of the development of our company, we have always had an eye on technological innovations that aimed to reduce the environmental impact of industrial production even more. Step by step we have reached increasingly important and ambitious stages, up to the result we have always dreamed of: creating products made from 100% regenerated material.*





# > ECO STONES

Prodotto italiano ecosostenibile  
Eco-sustainable Italian product



Questi piccoli sassi, realizzati con plastica rigenerata al 100%, rappresentano una scelta ecologica perché sono composti da scarti di plastica che altrimenti diventerebbero rifiuti destinati ad inquinare l'ambiente. Questi sassi sono inoltre sinonimo di sicurezza, dato che hanno un peso specifico molto basso.

*These small stones, made with 100% regenerated plastic, represent an ecological choice, because are composed of all the plastic waste that otherwise they would become waste destined to pollute the environment. These regenerated stones are also synonymous with safety, since they have a very low specific weight.*



**SASS1/AN**



**SASS1/BI**



**SASS1/CO**



**SASS1/GC**



**SASS2/AN**



**SASS2/BI**



**SASS2/CO**



**SASS2/GC**

## ARTICOLO / ARTICLE

	Larghezza Width	Profondità Depth	Altezza Height	Codice a barre Barcode
<b>SASS1/AN</b>	170	45	300	8010693125050
<b>SASS1/BI</b>	170	45	300	8010693125067
<b>SASS1/CO</b>	170	45	300	8010693125074
<b>SASS1/GC</b>	170	45	300	8010693125081
<b>SASS2/AN</b>	170	45	300	8010693125517
<b>SASS2/BI</b>	170	45	300	8010693125524
<b>SASS2/CO</b>	170	45	300	8010693125531
<b>SASS2/GC</b>	170	45	300	8010693125548

## IMBALLO / PACKING

Pz. Pc.	Tipo Type	Larghezza Width	Profondità Depth	Altezza Height
6	cartone/carton	203	206	250
6	cartone/carton	203	206	250
6	cartone/carton	203	206	250
6	cartone/carton	203	206	250
6	cartone/carton	203	206	250
6	cartone/carton	203	206	250
6	cartone/carton	203	206	250
6	cartone/carton	203	206	250

Tutte le misure sono espresse in millimetri / All measures are in millimeters

# Linea **NOVA VITA**



Garantito 10 anni  
uso interno/esterno  
*Guaranteed 10 years  
indoor/outdoor use*



**100%**  
REGENERATED

Completamente  
rigenerato  
*Completely  
regenerated*



Sovrapponibili  
*Stackable*

Spessore  
5 - 15 mm  
*Thickness  
5 - 15 mm*

Rifinito a mano  
*Hand Finishing*



**plastica**  
seconda vita  
MIX ECO

I vasi di design della Linea NOVA VITA, ottenuti da materiali rigenerati mix-eco, sono rifiniti a mano. Progettati e prodotti interamente in Italia rappresentano idealmente il connubio del bello tipico del gusto italiano con la sensibilità verso una problematica sempre più attuale come la sostenibilità dei prodotti che utilizziamo.



*The NOVA VITA's design pots, obtained from mix-eco regenerated materials, are finished by hand. Designed and produced entirely in Italy, they ideally represent the combination of the typical beauty of Italian taste with the sensitivity towards an increasingly current issue such as the sustainability of the products we use.*



#### Cos'è "ReMade in Italy"?

Questa certificazione permette al prodotto di rientrare nel codice appalti per le pubbliche amministrazioni, nel CAM (criteri ambientali minimi) e esonera dal pagamento della Plastic Tax.

#### What is "ReMade in Italy"?

This certification allows the product to be included in the procurement code for public administrations, in the CAM (minimum environmental criteria) and exempts the payment of the Plastic Tax.

#### Cos'è "Plastica Seconda Vita"?

ArtPlast è tra le prime aziende in Italia certificate da IPPR (Istituto per la Promozione delle Plastiche da Riciclo), con il marchio "Plastica Seconda Vita", una certificazione dedicata ai manufatti ottenuti dalla valorizzazione del riciclo dei materiali plastici. Introduce i concetti di qualità e durabilità nelle materie plastiche da riciclo e ne garantisce la tracciabilità in tutta la sua filiera.

#### What is "Plastica Seconda Vita"?

ArtPlast is among the first companies in Italy certified by IPPR (Institute for the Promotion of Recycling Plastics) with the brand "Second Life Plastic", a certification dedicated to the products obtained from the enhancement of the recycling of plastic materials. It introduces the concepts of quality and durability in recycled plastics and ensures traceability throughout its supply chain.

# Linea **NOVA VITA**



prodotto 100%  
rigenerato  
product 100%  
regenerated



non assorbe  
gli odori  
odor-proof



non trattiene  
umidità  
doesn't retain  
humidity





**Ø70mm h 57mm**

- ATC.007.SB.GC
- ATC.007.SB.AN
- ATC.007.SB.BI
- ATC.007.SB.CO
- ATC.007.SB.MA

- ATC.010.SB.GC
- ATC.010.SB.AN
- ATC.010.SB.BI
- ATC.010.SB.CO
- ATC.010.SB.MA



**Ø100mm h 95mm**

- ASO.010.SV.GC
- ASO.010.SV.AN
- ASO.010.SV.BI
- ASO.010.SV.CO
- ASO.010.SV.MA

- ASO.015.SV.GC
- ASO.015.SV.AN
- ASO.015.SV.BI
- ASO.015.SV.CO
- ASO.015.SV.MA



**Ø150mm h 130mm**

- ATC.015.SB.GC
- ATC.015.SB.AN
- ATC.015.SB.BI
- ATC.015.SB.CO
- ATC.015.SB.MA

- ATC.020.SB.GC
- ATC.020.SB.AN
- ATC.020.SB.BI
- ATC.020.SB.CO
- ATC.020.SB.MA



**Ø200mm h 175mm**

- ASO.020.SV.GC
- ASO.020.SV.AN
- ASO.020.SV.BI
- ASO.020.SV.CO
- ASO.020.SV.MA

- ASO.030.SV.GC
- ASO.030.SV.AN
- ASO.030.SV.BI
- ASO.030.SV.CO
- ASO.030.SV.MA



**Ø300mm h 250mm**

- ATC.030.SB.GC
- ATC.030.SB.AN
- ATC.030.SB.BI
- ATC.030.SB.CO
- ATC.030.SB.MA

# > LEONARDO

ASO.040.SV.GC   
 ASO.040.SV.AN   
 ASO.040.SV.BI   
 ASO.040.SV.CO   
 ASO.040.SV.MA 



ATC.040.SB.GC   
 ATC.040.SB.AN   
 ATC.040.SB.BI   
 ATC.040.SB.CO   
 ATC.040.SB.MA 

**Ø400mm h 340mm**



**Ø500mm h 470mm**

ATC.050.SB.GC   
 ATC.050.SB.AN   
 ATC.050.SB.BI   
 ATC.050.SB.CO   
 ATC.050.SB.MA 

ASO.050.SV.GC   
 ASO.050.SV.AN   
 ASO.050.SV.BI   
 ASO.050.SV.CO   
 ASO.050.SV.MA 



- ATC.075.SB.GC**
- ATC.075.SB.AN**
- ATC.075.SB.BI**
- ATC.075.SB.CO**
- ATC.075.SB.MA**

**Ø730mm h 645mm**



- ASO.075.SV.GC**
- ASO.075.SV.AN**
- ASO.075.SV.BI**
- ASO.075.SV.CO**
- ASO.075.SV.MA**

- ATC.075.RU.GC**
- ATC.075.RU.AN**
- ATC.075.RU.BI**
- ATC.075.RU.CO**
- ATC.075.RU.MA**

Opzione con ruote che ne facilitano lo spostamento  
*Option with wheels for easy movement*

NEW! NEW! NEW! NEW! NEW!

# Linea **NOVA VITA**



prodotto 100%  
rigenerato  
product 100%  
regenerated



non assorbe  
gli odori  
odor-proof



non trattiene  
umidità  
doesn't retain  
humidity



# > TINTORETTO

Prodotto italiano ecosostenibile  
Eco-sustainable italian product



GARDEN



**Ø300mm h 118mm**

	Colore Color	Codice a barre Barcode
<b>ARE.030.SB.GC</b>		8010693125654
<b>ARE.030.SB.AN</b>		8010693125661
<b>ARE.030.SB.BI</b>		8010693125678
<b>ARE.030.SB.CO</b>		8010693125685
<b>ARE.030.SB.MA</b>		8010693125692



**Ø350mm h 118mm**

	Colore Color	Codice a barre Barcode
<b>ARE.035.SB.GC</b>		8010693125708
<b>ARE.035.SB.AN</b>		8010693125715
<b>ARE.035.SB.BI</b>		8010693125722
<b>ARE.035.SB.CO</b>		8010693125739
<b>ARE.035.SB.MA</b>		8010693125746

Linea  
**NOVA VITA**



prodotto 100%  
rigenerato  
product 100%  
regenerated





non assorbe  
gli odori  
odor-proof





non trattiene  
umidità  
doesn't retain  
humidity

# > BRUNELLESCHI



**ATA.013.SB.AN**   
**ATA.013.SB.BI** 



**Ø130mm h 60mm**

**ATA.018.SB.AN**   
**ATA.018.SB.BI** 



**Ø180mm h 82mm**



**ATA.022.SB.AN**   
**ATA.022.SB.BI** 

**Ø220mm h 95mm**

# Linea **NOVA VITA**



prodotto 100%  
rigenerato  
product 100%  
regenerated



non assorbe  
gli odori  
odor-proof



non trattiene  
umidità  
doesn't retain  
humidity

# > MICHELANGELO



- ASB.030.SV.GC
- ASB.030.SV.AN
- ASB.030.SV.BI
- ASB.030.SV.CO
- ASB.030.SV.MA



- ABA.030.SB.GC
- ABA.030.SB.AN
- ABA.030.SB.BI
- ABA.030.SB.CO
- ABA.030.SB.MA



**L300mm h 93mm**

- ASB.050.SV.GC
- ASB.050.SV.AN
- ASB.050.SV.BI
- ASB.050.SV.CO
- ASB.050.SV.MA



- ABA.050.SB.GC
- ABA.050.SB.AN
- ABA.050.SB.BI
- ABA.050.SB.CO
- ABA.050.SB.MA



**L500mm h 161mm**

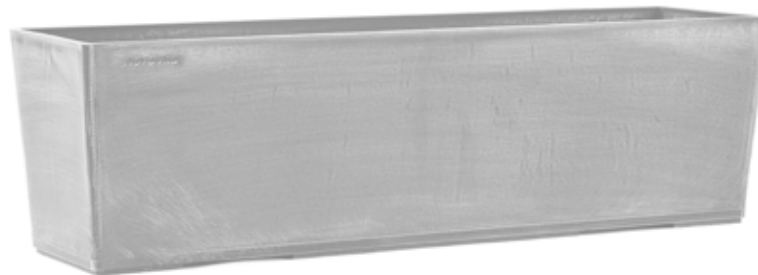

- ABA.060.SB.GC
- ABA.060.SB.AN
- ABA.060.SB.BI
- ABA.060.SB.CO
- ABA.060.SB.MA



**L600mm h 161mm**

- ASB.060.SV.GC
- ASB.060.SV.AN
- ASB.060.SV.BI
- ASB.060.SV.CO
- ASB.060.SV.MA

# Linea **NOVA VITA**



prodotto 100%  
rigenerato  
product 100%  
regenerated



non assorbe  
gli odori  
odor-proof



non trattiene  
umidità  
doesn't retain  
humidity



Orto urbano  
*Urban garden*



# > GIOTTO

La linea GIOTTO è caratterizzata da una varietà di possibili utilizzi:  
orto urbano, grande fioriera, fish pond.

*The GIOTTO line is characterized by a variety of possible uses: urban vegetable garden, large flower box, fish pond.*



- ATC.085.SB.GC 
- ATC.085.SB.AN 
- ATC.085.SB.BI 
- ATC.085.SB.CO 
- ATC.085.SB.MA 

**Ø820mm h 220mm**

Opzione con ruote che ne facilitano lo spostamento  
*Option with wheels for easy movement*

- ATC.085.RU.GC 
- ATC.085.RU.AN 
- ATC.085.RU.BI 
- ATC.085.RU.CO 
- ATC.085.RU.MA 



# Linea **NOVA VITA**



prodotto 100%  
rigenerato  
product 100%  
regenerated



non assorbe  
gli odori  
odor-proof



non trattiene  
umidità  
doesn't retain  
humidity







- ACU.040.SB.GC**
- ACU.040.SB.AN**
- ACU.040.SB.BI**
- ACU.040.SB.CO**
- ACU.040.SB.MA**

**L400mm h 400mm**



- ACU.080.SB.GC**
- ACU.080.SB.AN**
- ACU.080.SB.BI**
- ACU.080.SB.CO**
- ACU.080.SB.MA**

**L800mm h 400mm**

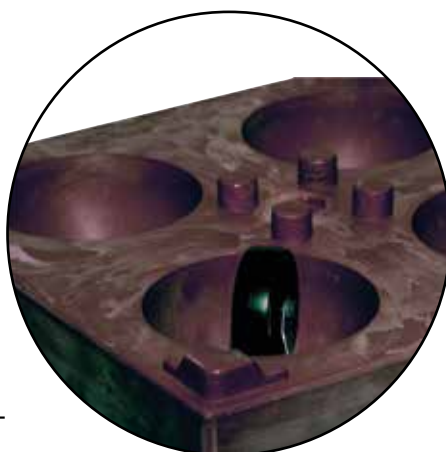

Opzione con ruote che ne facilita-  
no lo spostamento

*Option with wheels for easy move-  
ment*

**RUO.007.SU.NE**

# Linea **NOVA VITA**



prodotto 100%  
rigenerato  
product 100%  
regenerated







non assorbe  
gli odori  
odor-proof



non trattiene  
umidità  
doesn't retain  
humidity

77



- ATI.030.SB.GC 
- ATI.030.SB.AN 
- ATI.030.SB.BI 
- ATI.030.SB.CO 
- ATI.030.SB.MA 

**Ø300mm h 520mm**



## Layout **SCAFFALATURA**

*“Ti aiutiamo a gestire i tuoi spazi con le nostre soluzioni: casa, ferramenta, pavimenti, automotive, animali e giardino.”*

*“We help you manage your space with our solutions: home, hardware, flooring, automotive, animal and garden.”*

# > Scaffale **FERRAMENTA**

"TI AIUTIAMO A GESTIRE I TUOI SPAZI  
CON LE NOSTRE SOLUZIONI"



**COMPOSIZIONE  
A SCAFFALE DA 1,33 mt**



Scaffale  
Singolo

HOBBY24  
HOBBY15  
HOBBY12  
802  
2500  
3400  
3300  
3200  
3100  
5300  
5400  
5500  
5550  
326  
6700R  
102  
103  
104

**COMPOSIZIONE  
A SCAFFALE DA 2,66 mt**



Scaffale 1    Scaffale 2

HOBBY24	501T
HOBBY15	511T
HOBBY12	512T
802	514T
2500	3350
3400	3100T
3300	3200T
3200	3300T
3100	3350T
5300	3500
5400	3600
5500	5440/12
5550	5700
326	5600
6700R	
102	
103	
104	
105	

**COMPOSIZIONE  
A SCAFFALE DA 3,99 mt**



Scaffale 1    Scaffale 2    Scaffale 3

HOBBY24	501T	611T
HOBBY15	511T	612T
HOBBY12	512T	613T
802	514T	614T
2500	3350	3710
3400	3100T	2311
3300	3200T	2211
3200	3300T	6700V
3100	3350T	6500V
5300	3500	6300V
5400	3600	A 2
5500	5440/12	B 3
5550	5700	D 4
326	5600	E 5
6700R		F 6
102		
103		
104		
105		

# > Scaffale **FERRAMENTA**

"TI AIUTIAMO A GESTIRE I TUOI SPAZI  
CON LE NOSTRE SOLUZIONI!"



## COMPOSIZIONE A SCAFFALE DA **5,32 mt**



Scaffale 1	3200	102	514T	5440/12	3710	D 4	325
HOBBY24	3100	103	3350	5700	2311	E 5	330
HOBBY15	5300	104	3100T	5600	2211	F 6	332
HOBBY12	5400	105	3200T	<b>Scaffale 3</b>	6700V	<b>Scaffale 4</b>	321
802	5500	<b>Scaffale 2</b>	3300T	611T	6500V	3100V	319
2500	5550	501T	3350T	612T	6300V	3200V	
3400	326	511T	3500	613T	A 2	3300V	
3300	6700R	512T	3600	614T	B 3	3351V	

## COMPOSIZIONE A SCAFFALE DA **6,65 mt**



Scaffale 1	3100	104	3200T	611T	6300V	3300V	701T	L2R
HOBBY24	5300	105	3300T	612T	A 2	3351V	702T	L3030N
HOBBY15	5400	<b>Scaffale 2</b>	3350T	613T	B 3	325	703T	L4040N
HOBBY12	5500	501T	3500	614T	D 4	330	2411	
802	5550	511T	3600	3710	E 5	332	322	
2500	326	512T	5440/12	2311	F 6	321	L1410N	
3400	6700R	514T	5700	2211	<b>Scaffale 4</b>	319	L3610N	
3300	102	3350	5600	6700V	3100V	<b>Scaffale 5</b>	L4829N	
3200	103	3100T	<b>Scaffale 3</b>	6500V	3200V	320	L5838N	

# > Scaffale **HOME**

"TI AIUTIAMO A GESTIRE I TUOI SPAZI  
CON LE NOSTRE SOLUZIONI!"



**COMPOSIZIONE  
A SCAFFALE DA 1,50 mt**



Scaffale Singolo

M31T  
M31BT  
M31AT  
M41T  
M41BT  
M41AT  
M76T  
M76BT  
M76AT  
M86T  
M86AT  
M86BT  
MP40TTV  
MP70TTV  
MP90TTV  
U50FRW  
U50FRT  
CB1T

**COMPOSIZIONE  
A SCAFFALE DA 2,83 mt**



Scaffale 1

Scaffale 2

M31T	U50/1W
M31BT	U50/1G
M31AT	U50/1R
M41T	U50/1B
M41BT	U50/1N
M41AT	U50/1TO
M76T	U50E
M76BT	U22E/KIT
M76AT	U22TO/KIT
M86T	U22AN/KIT
M86AT	
M86BT	
MP40TTV	
MP70TTV	
MP90TTV	
U50FRW	
U50FRT	
CB1T	

# > Scaffale **EUROBOX**

**COMPOSIZIONE  
A SCAFFALE DA 1,50 mt**



Scaffale Singolo

EN201507GC  
EN201512GC  
EN201517GC  
EN302007GC  
EN302012GC  
EN302017GC  
EN201517BGC  
EN302017BGC  
EN403022BGC  
EN604012GC  
EN604022GC  
EN604032GC  
EN2015SGC  
EN3020SGC  
EN4030SGC  
EN6040SGC

**COMPOSIZIONE  
A SCAFFALE DA 3,00 mt**



Scaffale 1

Scaffale 2

EN201507GC	EN403022DGC
EN201512GC	EN604012DGC
EN201517GC	EN604022DGC
EN302007GC	EN604032DGC
EN302012GC	EN201517T
EN302017GC	EN403022T
EN201517BGC	EN302017T
EN302017BGC	EN604012T
EN403022BGC	EN604022T
EN604012GC	EN604032T
EN604022GC	EN6040ST
EN604032GC	EN4030ST
EN2015SGC	EN3020ST
EN3020SGC	EN2015ST
EN4030SGC	
EN6040SGC	

# > Scaffale **TEMPO**

"TI AIUTIAMO A GESTIRE I TUOI SPAZI  
CON LE NOSTRE SOLUZIONI!"



**COMPOSIZIONE  
A SCAFFALE DA 1,50 mt**

**COMPOSIZIONE  
A SCAFFALE DA 2,80 mt** *Linea*  
**TEMPO**



Scaffale  
Singolo

T60/4 E  
T80/5 E  
T60/4  
T70/5  
T80/5  
T90/5  
T100/5



Scaffale

T60/4E

T80/5E

T60/4

T80/5

**COMPOSIZIONE  
A SCAFFALE DA**

**4,00 mt**

*Linea*  
**TEMPO**



Scaffale

T60/4

T70/5

T80/5

T90/5

T100/5



# > Scaffale **ARMADI**

"TI AIUTIAMO A GESTIRE I TUOI SPAZI  
CON LE NOSTRE SOLUZIONI!"



**COMPOSIZIONE  
A SCAFFALE DA 2,20 mt**

Linea  
**SPAZIO**

Scaffale

S70/BT

S70/PST

S70/TPT



**COMPOSIZIONE  
A SCAFFALE DA 2,20 mt**

Linea  
**STEEL**

Scaffale

S71/BT

S71/PST

S71/TPT



**COMPOSIZIONE  
A SCAFFALE DA 2,20 mt**

Linea  
**EVOLUTION**

Scaffale

EV070/TPT

EV0707BT

EV070/PST



# > Scaffale **ARMADI**

"TI AIUTIAMO A GESTIRE I TUOI SPAZI  
CON LE NOSTRE SOLUZIONI"



## COMPOSIZIONE A SCAFFALE DA

### 2,20 mt

Scaffale

E71B

E71PS

E71TP



LINEA

# easy

## COMPOSIZIONE A SCAFFALE DA

### 4,50 mt

Scaffale

E101B

E71B

E101

E71PS

E71TP

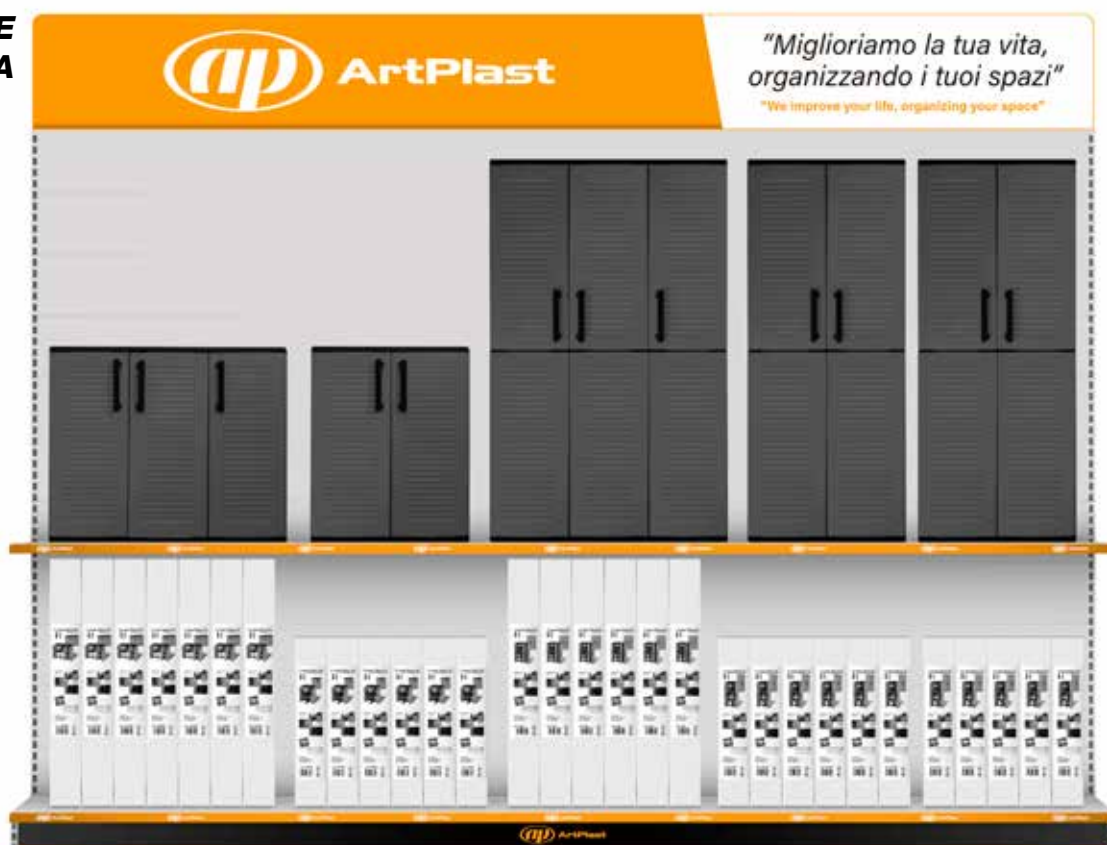

# > Scaffale **ARMADI**

"TI AIUTIAMO A GESTIRE I TUOI SPAZI  
CON LE NOSTRE SOLUZIONI!"



## COMPOSIZIONE A SCAFFALE DA

**2,20 mt**

Scaffale

F70PS

F70B

F70TP



LINEA  
**FAMILY**

## COMPOSIZIONE A SCAFFALE DA

**4,50 mt**

Scaffale

F100B

F70B

F100

F70PS

F70TP

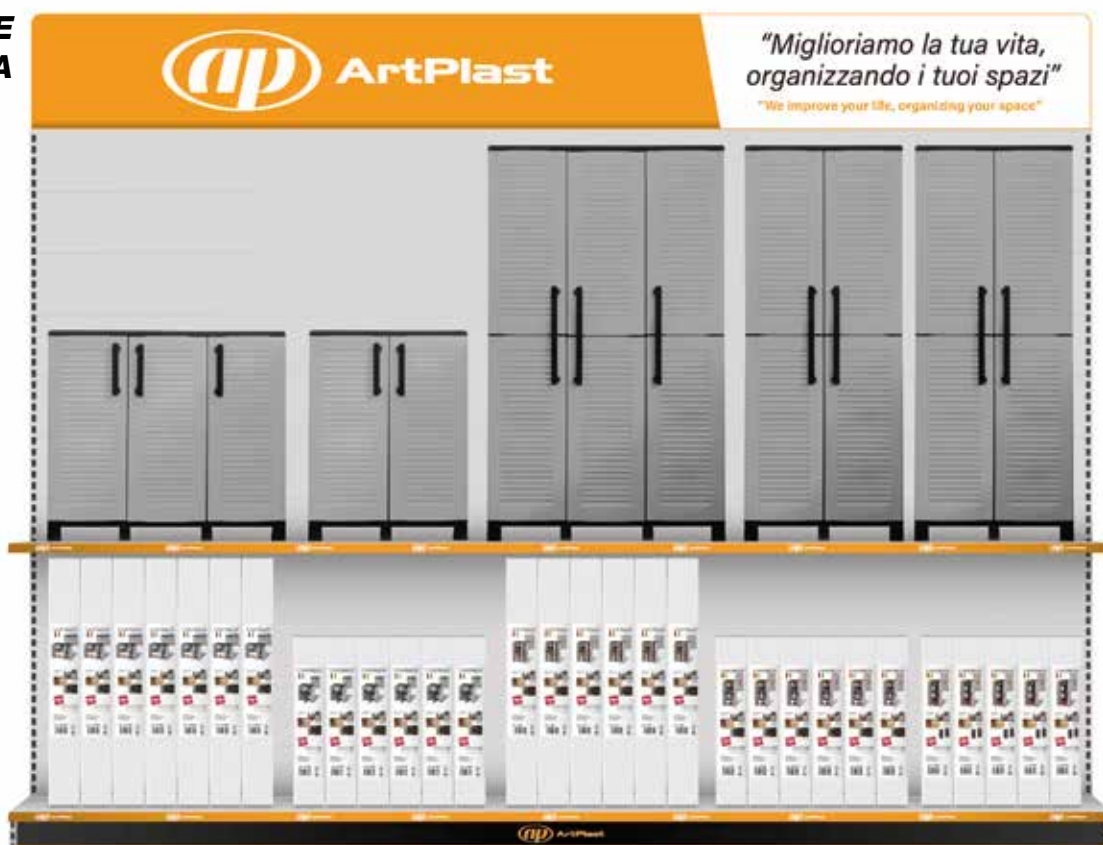

# > Scaffale **ARMADI**

"TI AIUTIAMO A GESTIRE I TUOI SPAZI  
CON LE NOSTRE SOLUZIONI"



## COMPOSIZIONE A SCAFFALE DA

**2,20 mt**

Scaffale

F71B

F71PS

F71TP



LINEA

# FREE

## COMPOSIZIONE A SCAFFALE DA

**4,50 mt**

Scaffale

F101B

F71B

F101

F71PS

F71TP



# > Scaffale **ARMADI**

"TI AIUTIAMO A GESTIRE I TUOI SPAZI  
CON LE NOSTRE SOLUZIONI!"



## COMPOSIZIONE A SCAFFALE DA

**2,20 mt**

Scaffale

I70B

I70PS

I70TP



LINEA

**idea!**

## COMPOSIZIONE A SCAFFALE DA

**4,50 mt**

Scaffale

I100B

I70B

I100

I70PS

I70TP

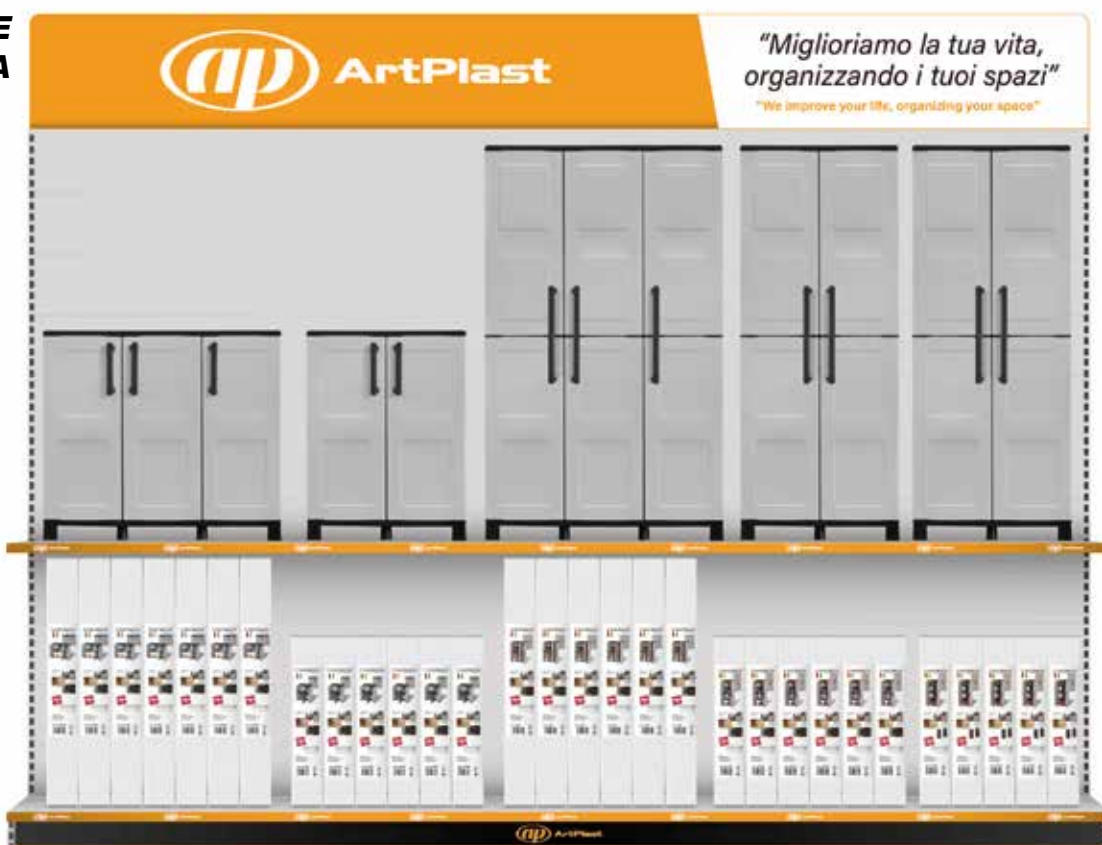

# > Scaffale **BIO**

"TI AIUTIAMO A GESTIRE I TUOI SPAZI  
CON LE NOSTRE SOLUZIONI"



**COMPOSIZIONE  
A SCAFFALE DA 1,50 mt**



Scaffale  
Singolo

BS7V  
BS7M  
BS10V  
BS10M  
BS30B  
BS30G  
R34/1G  
R34/1V  
R34/1B  
R34/1R  
F70ECOLOR3  
F70ECO

**COMPOSIZIONE  
A SCAFFALE DA 3,00 mt**



Scaffale 1

Scaffale 2

BS7V  
BS7M  
BS10V  
BS10M  
BS30B  
BS30G  
R34/1G  
R34/1V  
R34/1B  
R34/1R  
F70ECOLOR3  
F70ECO

F70/EC03  
F100/ECOLOR  
RS/4  
BS35/G  
BS35/R  
BS35/B  
BS30/LOT3

# > Scaffale **PET**

**COMPOSIZIONE  
A SCAFFALE DA 1,50 mt**



Scaffale  
Singolo

PM01/T0  
PM02/T0  
PM03/T0  
PT50  
PT80T  
PC1T  
PC2T  
PC3T  
PM10/E  
PM35/E

**COMPOSIZIONE  
A SCAFFALE DA 2,83 mt**



Scaffale 1

Scaffale 2

PM01/T0  
PM02/T0  
PM03/T0  
PT50  
PT80T  
PC1T  
PC2T  
PC3T  
PM10/E  
PM35/E

PT80T  
PT90T  
PT100T

# > Scaffale **GARDEN**

"TI AIUTIAMO A GESTIRE I TUOI SPAZI  
CON LE NOSTRE SOLUZIONI!"



**COMPOSIZIONE  
A SCAFFALE DA 1,33 mt**



Scaffale  
Singolo

FB2/B  
FB1/A  
FB/V  
RF45V  
BR06GC  
J58  
STTO  
SMART  
BC380N

**COMPOSIZIONE  
A SCAFFALE DA 1,50 mt**



Scaffale 1      Scaffale 2

CAMPANA  
200mm  
250mm  
300mm  
350mm  
400mm  
  
CILINDRO  
180mm  
200mm  
220mm  
250mm  
300mm  
350mm  
400mm

QUADRA MAXI  
320mm  
380mm

CASSETTA  
MAXI  
600mm  
800mm

**SERIE  
SOTTOVASI**

**COMPOSIZIONE  
A SCAFFALE DA 3,00 mt**



Scaffale 1      Scaffale 2

CILINDRO  
160mm  
180mm  
200mm  
220mm  
250mm  
300mm  
350mm  
400mm  
450mm  
500mm  
600mm  
  
LAMPO  
280mm  
330mm

CAMPANA  
200mm  
250mm  
300mm  
350mm  
400mm

QUADRA MAXI  
320mm  
380mm

CASSETTA  
MAXI  
600mm  
800mm  
1000mm

**SERIE  
SOTTOVASI**

# > Scaffale **AUTOMOTIVE**

“TI AIUTIAMO A GESTIRE I TUOI SPAZI  
CON LE NOSTRE SOLUZIONI!”



## **SHIELD**

**COMPOSIZIONE  
A SCAFFALE DA 2,00 mt**

Scaffale Singolo

BA320

BA400/PA

BA480/PA



**COMPOSIZIONE  
A SCAFFALE DA 2,00 mt**

Scaffale Singolo

**DOPPIA APERTURA  
DOUBLE-SIDED OPENING**

BA320/DS

BA400/PA/DS

BA480/PA/DS

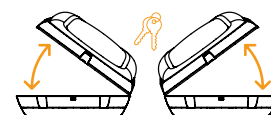



# > Scaffale **PENSILINE**

"TI AIUTIAMO A GESTIRE I TUOI SPAZI  
CON LE NOSTRE SOLUZIONI"



**COMPOSIZIONE  
A PARETE**

**6,00 mt**

SOLUZIONE IN ESTERNO:

PE50100T - PE80120T - PE100145T - PE120180T - PE140180T



# > Scaffale **PAVIMENTI**

**COMPOSIZIONE  
A PARETE**

**6,00 mt**

SOLUZIONE IN ESTERNO: E40 - E40A - E40LM - P40 - P40DEC - AT40PLAY - P39G - P50DF  
- P50MAN - P50MAPN - P50M5BLN - P50BLN - P50CRN - P56PQMS - P56PBD - FTB/6 - P60SP  
- P120M - PS120M/M - PS120M/F - PA120M - PC120G - PS120G/M - PS120G/F - PA120G - PWQ  
- PWL - PWXL - PW1 - PWS1/M - PW3 - PWS3/M - PWA



# > Scaffale **NOVAVITA**

COMPOSIZIONE  
A SCAFFALE DA **4,50 mt**

NovaVita<sup>l</sup>  
Regenerated Style

NOV  
Regene



# NovaVita

Regenerated Style

**SERIE NOVAVITA:**

LEONARDO - BRUNELLESCHI - TINTORETTO - CARAVAGGIO - MICHELANGELO - GIOTTO - TIZIANO

"TI AIUTIAMO A GESTIRE I TUOI SPAZI  
CON LE NOSTRE SOLUZIONI"



ovaVita  
Regenerated Style

NovaVita  
Regenerated Style





**NOTE NOTES**



A series of horizontal dotted lines for taking notes.



*Manufacturing in Italy* **since 1981**

---



[artplast.it](http://artplast.it)